

**nord lead**  
v i r t u a l a n a l o g

**OWNERS MANUAL**  
*Software Version 2.x – English*

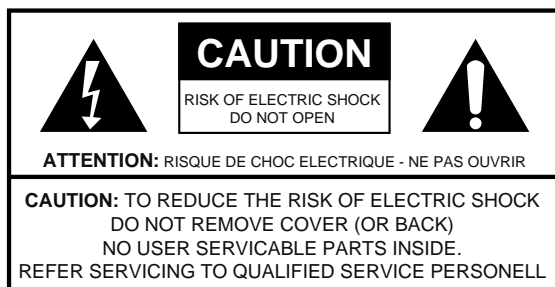

The lightning flash with the arrowhead symbol within an equilateral triangle is intended to alert the user to presence of uninsulated "dangerous voltage" within the product's enclosure that may be of sufficient magnitude to constitute a risk of electric shock to persons.



The exclamation point within an equilateral triangle is intended to alert the user to the presence of important operating and maintenance (servicing) instructions in the literature accompanying the product.

INSTRUCTIONS PERTAINING TO A RISK OF FIRE, ELECTRIC SHOCK, OR INJURY TO PERSONS.

## IMPORTANT SAFETY INSTRUCTIONS SAVE THESE INSTRUCTIONS

**WARNING** - When using electric products, basic precautions should always be followed, including the following:

1. Read all the instructions and observe the graphic symbols above before using the product.
2. This product must be grounded. If it should malfunction or break down, grounding provides a path of least resistance for electronic current, to reduce the risk of electric shock. This product is equipped with a power supply cord having an equipment grounding conductor and a grounding plug. The plug must be plugged into an appropriate outlet which is properly installed and grounded in accordance with all local codes and ordinances.  
**DANGER:** Improper connection of the equipment grounding conductor can result in a risk of electric shock. Do not modify the plug provided with the product. If it will not fit the outlet, have a proper outlet installed by a qualified electrician. Do not use an adaptor which defeats the function of the equipment-grounding conductor. If you are in doubt as to whether the product is properly grounded, check with a qualified serviceman or electrician.
3. Do not use this product near water – for example, near a bathtub, washbowl, kitchen sink, in a wet basement, or near a swimming pool, or the like.
4. This product should be used only with a cart or stand that is recommended by the manufacturer.
5. This product, either alone or in combination with an amplifier and headphones or speakers, may be capable of producing sound levels that could cause permanent hearing loss. Do not operate for a long period of time at a high volume level or at a level that is uncomfortable. If you experience any hearing loss or ringing in the ears, you should consult an audiologist.
6. The product should be located so that its location or position does not interfere with its proper ventilation.
7. The product should be located away from heat sources such as radiators, heat registers, or other products that produce heat.
8. The product should be connected to a power supply only of the type described in the operating instructions or as marked on the product.
9. The power supply cord of the product should be unplugged from the outlet when left unused for a long period of time.
10. Care should be taken so that objects do not fall and liquids are not spilled into the enclosure through openings.
11. The product should be serviced by qualified service personnel when:
  - A. The power supply cord or the plug has been damaged; or
  - B. Objects have fallen, or liquid has been spilled onto the product; or
  - C. The product has been exposed to rain; or
  - D. The product does not appear to operate normally or exhibits a marked change in performance; or
  - E. The product has been dropped or the enclosure damaged.
12. Do not attempt to service the product beyond that described in the user-maintenance instructions. All other servicing should be referred to qualified service personnel.

**For the USA - for equipment with polarized line plug:**

This product may be equipped with a polarized line plug (one blade wider than the other). This is a safety feature. If you are unable to insert the plug into the outlet, contact an electrician to replace your obsolete outlet. Do not defeat the safety purpose of the plug.

**For Canada - for equipment with polarized line plug:**

**CAUTION:** TO PREVENT ELECTRIC SHOCK; MATCH WIDE BLADE OF PLUG TO WIDE SLOT; FULLY INSERT.

**ATTENTION:** POUR EVITER LES CHOCES ELECTRIQUES, INTRODUIRE LA LAME LA PLUS LARGE DE LA FICHE DANS LA BORNE CORRESPONDANCE DE LA PRISE ET POUSSER JUSQU' AU FOND.

# TABLE OF CONTENTS

<b>INTRODUCTION</b>	<b>5</b>
Welcome! . . . . .	5
About This Manual . . . . .	5
Clavia on the Net . . . . .	5
<b>CONNECTIONS</b>	<b>7</b>
Connecting a Pedal. . . . .	8
<b>BASIC OPERATIONS</b>	<b>9</b>
Demo Play Function. . . . .	9
Basic MIDI Settings for the Nord Rack. . . . .	10
Selecting Programs . . . . .	11
Selecting Percussion Kits . . . . .	12
Using the Slots To Switch Programs . . . . .	12
Layering . . . . .	13
Replacing One Program In the Layer. . . . .	13
Selecting Performances . . . . .	14
Monophonic and Polyphonic Operation. . . . .	15
Stereo/Mono . . . . .	15
Pitch Stick and Modulation Wheel. . . . .	15
Master Tune . . . . .	16
Pedal . . . . .	17
The “Panic” button . . . . .	19
<b>EDITING PROGRAMS</b>	<b>21</b>
Changing An Existing Program . . . . .	21
Changing One Sound In A Layer . . . . .	21
Getting Back To The Programmed Sound. . . . .	21
Using Manual Mode . . . . .	22
Customizing Manual Mode. . . . .	22
Storing Programs . . . . .	23
Copying Programs . . . . .	23
Using PCMCIA Cards . . . . .	24
<b>PROGRAMMING VELOCITY SENSITIVITY</b>	<b>25</b>
The Filter Velocity Function. . . . .	25
Making Any Parameter Velocity Dependent . . . . .	25
Clearing Velocity Programming For One Knob. . . . .	27
Clearing All Velocity Programming . . . . .	27
Morphing . . . . .	28

<b>PERCUSSION KITS</b>	<b>29</b>
Selecting and playing a Percussion Kit . . . . .	29
Editing the sounds in a Percussion Kit . . . . .	30
Copying, Extracting and Importing individual Percussion sounds . . . . .	31
Saving Percussion Kits . . . . .	31
Sys Ex Dumps of Percussion Kits . . . . .	32
Using Percussion Kits in Performance Mode . . . . .	32
<b>PERFORMANCES</b>	<b>33</b>
What Are Performances? . . . . .	33
Recalling A Performance . . . . .	33
Editing the Performance . . . . .	34
Extracting Single Sounds from a Performance . . . . .	35
Saving a Performance . . . . .	35
Exiting Performance Mode . . . . .	36
What a Performance contains . . . . .	36
<b>PANEL REFERENCE</b>	<b>37</b>
Oscillator 1 . . . . .	37
Oscillator 2 . . . . .	38
Settings For Both Oscillators . . . . .	39
Amplifier . . . . .	40
Filter . . . . .	42
LFO 1 . . . . .	47
LFO 2/Arpeggiator . . . . .	48
Modulation Envelope . . . . .	50
Mod Wheel Destination . . . . .	52
Poly Legato Mono . . . . .	53
Unison . . . . .	53
Portamento . . . . .	54
Oct Shift . . . . .	54
<b>SHIFT FUNCTIONS</b>	<b>55</b>
Accessing The Shift Functions . . . . .	55
Tune (Master Tune) . . . . .	57
Out Mode . . . . .	57
Local . . . . .	58
Prog/Ctrl . . . . .	59
MIDI Channel . . . . .	59
Special . . . . .	61
System . . . . .	66
<b>MIDI</b>	<b>67</b>
About the MIDI Implementation . . . . .	67
Using Nord Lead With a Sequencer . . . . .	69
Bulk Dump . . . . .	71

---

<b>ABOUT SUBTRACTIVE SYNTHESIS</b>	<b>73</b>
Introduction . . . . .	73
The Building Blocks . . . . .	73
Connections . . . . .	74
The Oscillators and Waveforms . . . . .	74
The Filter . . . . .	79
The Amplifier . . . . .	84
Envelopes . . . . .	84
LFOs . . . . .	87
<b>MIDI IMPLEMENTATION</b>	<b>89</b>
Controller Number List . . . . .	89
System Exclusive Implementation . . . . .	91
<b>FACTORY SETTINGS</b>	<b>99</b>
Factory Programs . . . . .	99
Factory Percussion Kits . . . . .	100
Factory Performances . . . . .	102
About the Organ Sounds . . . . .	103
About the Prophet-5 factory sound recreations . . . . .	105
Restoring the Factory Programs in RAM . . . . .	106
<b>MIDI IMPLEMENTATION CHART</b>	<b>107</b>
<b>INDEX</b>	<b>109</b>



# 1. INTRODUCTION

## WELCOME!

We'd first like to thank you and congratulate to the purchase of a Nord Lead. You're about to begin a journey into the world of *virtual analog* synthesis. *Analog* because the Nord Lead mimics traditional analog synthesizers in a way no one thought was possible. *Virtual* because the Nord Lead is actually a digital instrument, remaining true to the traditional analog concept, and still managing to go beyond it!

But not all the magic lies in the sound creation. A major part is in the front panel, comprehensive, clearly laid out and smooth to operate.

## ABOUT THIS MANUAL

If you have some basic knowledge about programmable synthesizers, you probably won't need this manual much. Therefore it is arranged mainly as a reference text for those rare situation where something isn't as obvious as it should be.

## CLAVIA ON THE NET

If you have access to the World Wide Web you can get free sounds for your NordLead on [www.clavia.se](http://www.clavia.se). Here you will also find all the latest information about the Nord Lead and other Clavia products.





## 2. CONNECTIONS

- ▼ Make all connections before turning on your power amplifier!
- ▼ If you are using a Nord Rack together with a MIDI keyboard, connect a MIDI cable from MIDI Out on the keyboard to MIDI In on the Nord Rack.
- ▼ All signal cables used with the Nord Lead must be shielded.
- ▼ The L/R Outputs are line level.

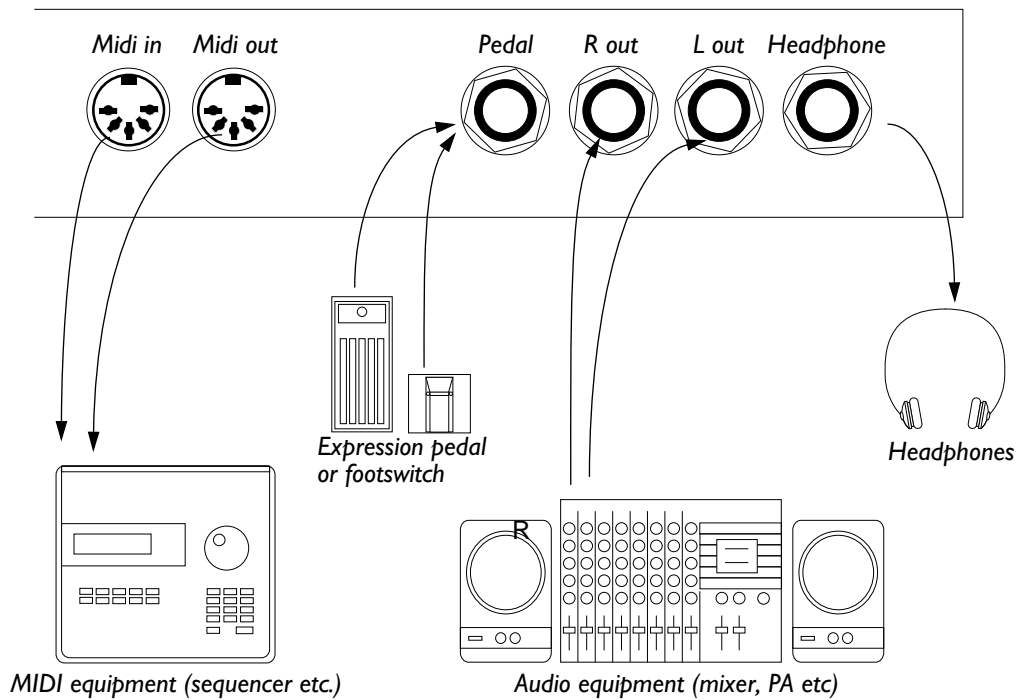

## CONNECTING A PEDAL

- ▼ If the Pedal input should be used for sustain, a regular footswitch and cable can be used.
- ▼ If the Pedal input should be used as a replacement for the modulation wheel, an “expression” pedal with a “stereo cable” should be used.

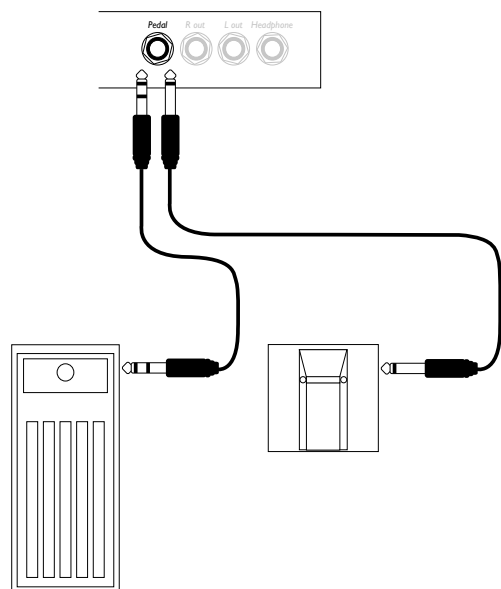

- ▼ For information on how to set the Nord Lead up for sustain or expression pedal, see page 17.

## 3. BASIC OPERATIONS

### DEMO PLAY FUNCTION

Before you try out the new features for yourself, you may want to listen to what can be done with the instrument. Luckily, the Nord Lead is equipped with a built-in demo playback function! There are six demo songs in ROM, showing the instrument's versatility and features in different contexts. To listen to the demo songs, proceed like this:

1. Simultaneously press the Shift and Sync (Demo) buttons.

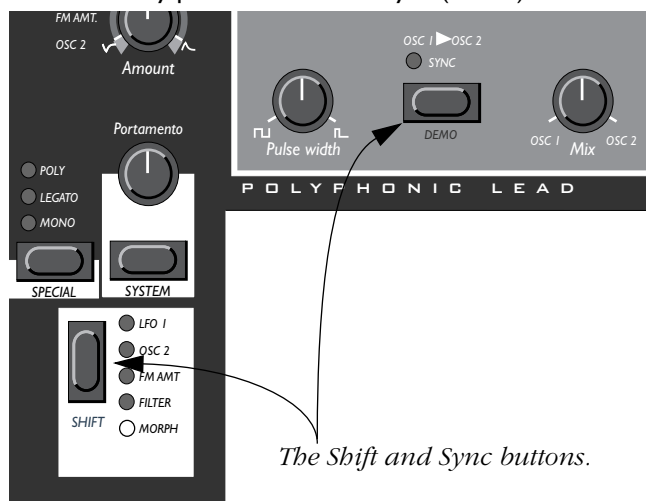

Playback starts. During playback, all knobs and buttons on the panel are disabled, except for Master Volume.

2. The demo songs are played back one after the other. If you want to move to the next or previous demo song, press the Up or Down button in the Program section of the panel.
3. To exit demo play mode, press any other button on the panel.

---

Please note that some of the demo songs make use of 12 voices, and will therefore only be played back on an expanded Nord Lead. If you use a 4-voice Nord Lead, you will not be able to select these demo songs.

---

## BASIC MIDI SETTINGS FOR THE NORD RACK

If you are using the Nord Rack and controlling it from a MIDI keyboard, the Nord Rack must be set to receive on the same MIDI channel that the keyboard transmits on. To get started, proceed as follows:

1. Set the keyboard to transmit on MIDI Channel 1.
2. Press the Program Slot A button, so that the LED above the button is lit.

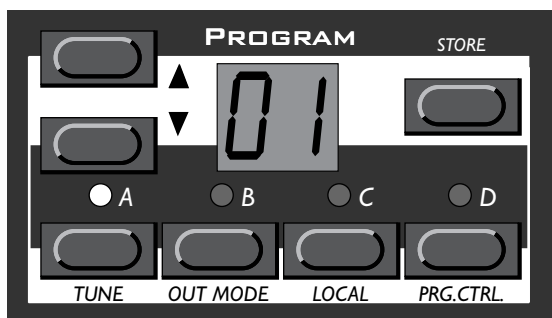

3. Hold down the Shift button and press the MIDI Ch (Unison) button.

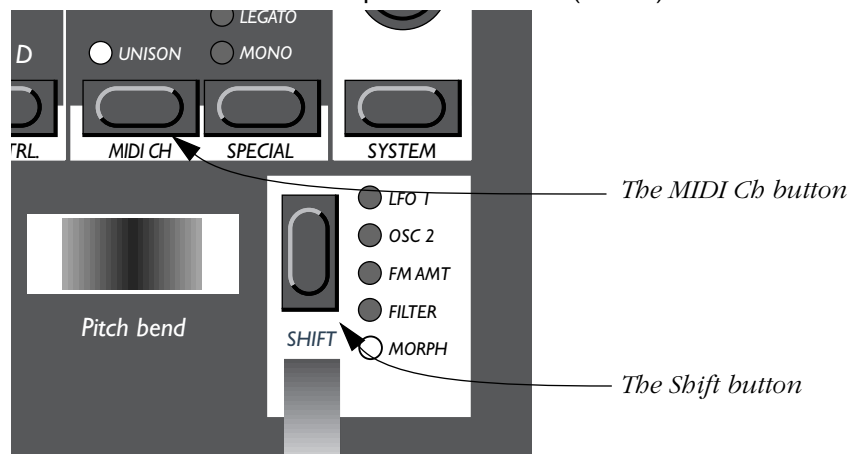

The display will now show the MIDI Channel setting for Slot A (1 – 16 or off).

4. Use the Program Up/Down buttons to select MIDI Channel 1.

*MIDI Channel 1 selected.*

*The Program Up/Down buttons*

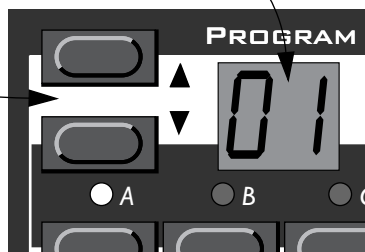

5. Press Shift again to return to the normal play mode.

If you use Slot A when you play the Nord Rack (if you like, together with other Slots), this simple setting should be sufficient in most situations - even when playing Layers and Performances, as described later in this manual. For more information, see page 69.

## SELECTING PROGRAMS

Programs are sounds that you have prepared in advance. The basic memory in the Nord Lead contains 99 Programs. 40 of these can be used for storing your own Programs, see below.

There are also four Program slots labelled A to D. The slots can be used for layering and quickly switching between programs as described below. They are also used when the Nord Lead is played via MIDI.

**1. Select a Program Slot to play by pressing one of the four buttons A to D.**

When you are only playing one sound at a time, as you are now, you can select any slot.

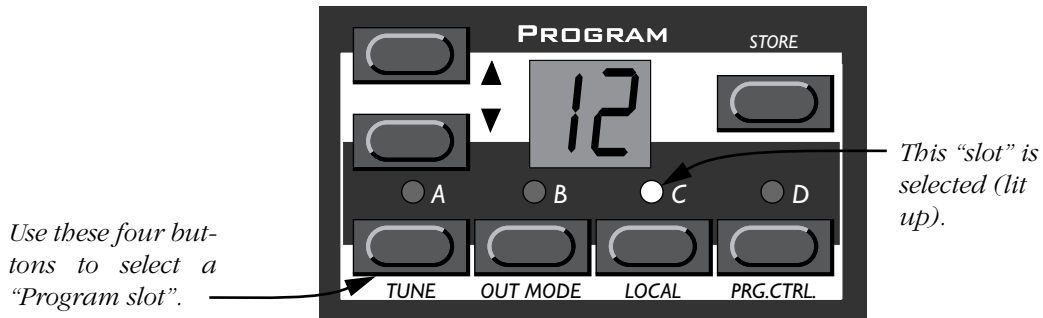

**2. Use the Program Up/Down keys to select a Program for that slot.**

Holding down a button scrolls the value quickly. Holding down the Shift key (the button above the Modulation wheel) while pressing the buttons makes the value change in steps of ten.

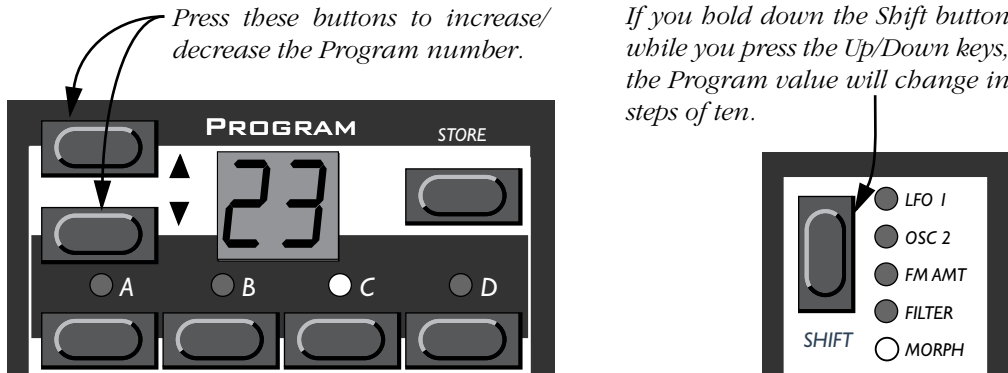

There are 99 Programs to select from. If you have a PCMCIA card inserted in the holder on the back (to do this you must have the expansion card installed), you may have another 297 on this, arranged in three banks. Dots to the right and between the numeral in the display indicate new Banks.

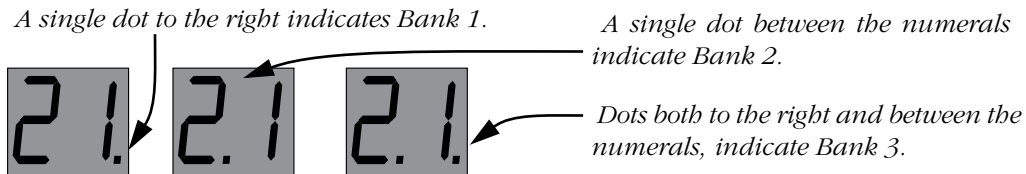

## SELECTING PERCUSSION KITS

In addition to the 99 Programs in the basic memory, there are 10 *Percussion Kits*. Each Percussion Kit consists of eight different virtual analog percussion sounds, arranged in zones across the keyboard. The Kits are located “above” Program number 99, and numbered “P0” to “P9”.

- ▼ To select a Percussion Kit for a Slot, proceed just as when selecting a regular Program: Use the Program Up/Down buttons to scroll to the desired Percussion Kit location.

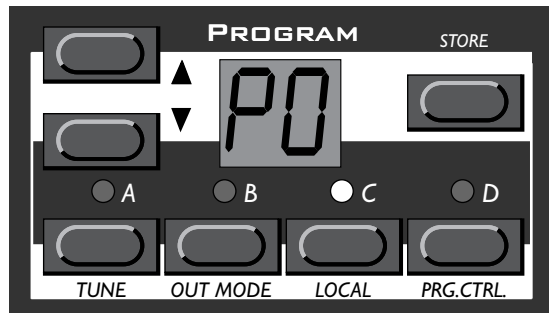

*Percussion Kit P0 selected.*

For detailed information about how to play and edit the Percussion Kits, see page 29.

## USING THE SLOTS TO SWITCH PROGRAMS

The four Program Slots A to D can be thought of as four independent synthesizers, each capable of playing one Program or Percussion Kit. When you select one of the slots you will switch to play the Program set for that slot.

For live performance, for example, you can set up each slot to play a different Program and quickly switch between those four by pressing the buttons A to D.

## LAYERING

### Activating

You can play more than one Program at a time. Proceed as follows:

1. Set up the Program slots to play the Programs you want to use.
2. To activate more than one Program slot, simply press all the Program Slot buttons you want to use, at the same time.

All those slots' LEDs light up. The last one you pressed, is blinking. This will be the one you are editing from the front panel, but more on this on page 21.

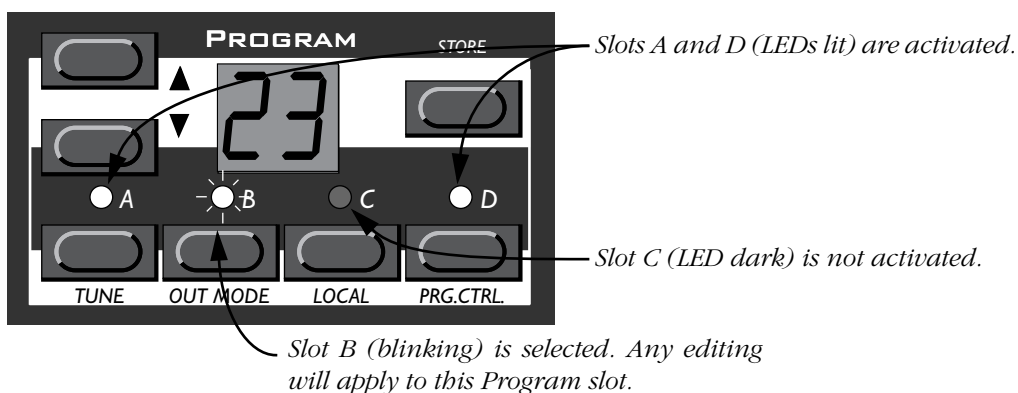

### Deactivating

To turn off the layer, press a slot button that is not part of the layer, or press all the buttons that make up the layer.

### Polyphony

How many notes you can play when layering sounds depends on two things:

1. How many voices you have in your instrument (the basic four or the expanded twelve).
2. What Play modes and Unison settings each Program uses. See page 53.

## REPLACING ONE PROGRAM IN THE LAYER

You might want to select another Program for one of the slots in the layer:

1. Press the Program Slot button that you want to select Programs for. Its LED will flash to indicate it is the *active slot*.
2. Select a new Program for that slot.

## SELECTING PERFORMANCES

A Performance is a collection of four Programs, one for each slot. Furthermore, the Performance contains information about which Programs should be active (layered).

In fact, a Performance also contains information about what MIDI Channels to use for each slot, and a number of other settings, but this is described in detail on page 33. This text is only meant as a quick introduction to playing the factory Performances.

1. If you have the rack version of the Nord Lead, make sure you transmit on MIDI Channel 1.  
This is because the factory Performances are set to receive on MIDI Channel 1.

2. Enter Performance mode by holding down Shift and pressing Performance (Manual).  
The display shows the latest selected Performance.

The Performances are organised in 10 Banks, named alphabetically from A to L (the letters I and K are excluded because they're hard to write clearly on the display). In each Bank there are 10 Performances, for a total of 100. If you have a PCMCIA card inserted, the Banks on the card are found after the internal (ROM) Banks and labelled in the same way, but indicated with a dot to the right of the digits in the display.

3. If you want to select another Bank (A to L), hold down Shift and press the Up and Down buttons.

4. To select a Performance in the Bank use the Up and Down buttons.

The Performance is instantly loaded and you can try it out. For a list of the factory Performances, see page 102.

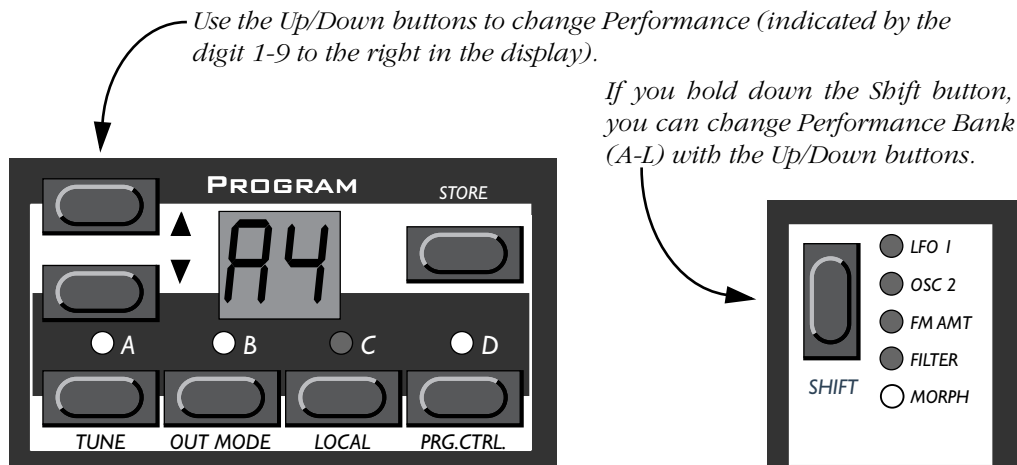

5. When you are done, exit Performance mode by again holding down Shift and pressing Performance (Manual).



## MONOPHONIC AND POLYPHONIC OPERATION

For each Program you can set a Play Mode (Poly, Mono, Legato). The exact nature of these modes is described on page 53.

To make a sound fatter, you can activate Unison. This reduces polyphony. See page 53 for details.

*Press this button to turn Unison on and off. The LED above the button indicates that Unison is activated.*

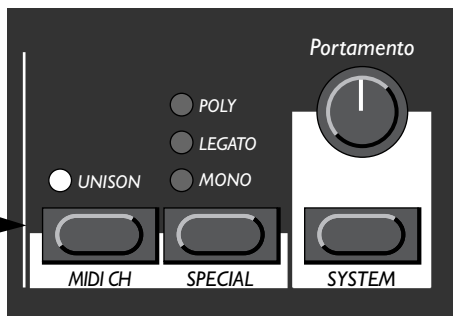

## STEREO/MONO

If you are using both the Left and Right outputs, or headphones, you might want to know something about how the sounds get positioned in the stereo image.

The complex answer is that this depends on the Out Mode settings as described on page 57. However, the simple truth is that in the basic mode, which the Nord Lead is set to when it comes from the factory, all Programs are in mono. In fact, there's one exception: If a Program is set to Unison, the instrument is switched to stereo operation.

## PITCH STICK AND MODULATION WHEEL

### *Pitch Stick*

The Pitch Stick is used to bend the notes, just as with a pitch bend wheel on traditional instruments. The pitch stick differs from other pitch bend devices in a couple of ways:

- ▼ There is no dead centre in the middle of the throw. This allows you to use the pitch stick for natural vibrato, pretty much like a guitarist can.
- ▼ The effect on pitch is logarithmic, that is, the further you move the stick away from the centre position, the more drastic the effect will be.

To set the range of the Pitch Stick, proceed as follows:

1. Hold down the Shift button.

2. With the Shift button down, press the button labelled System.

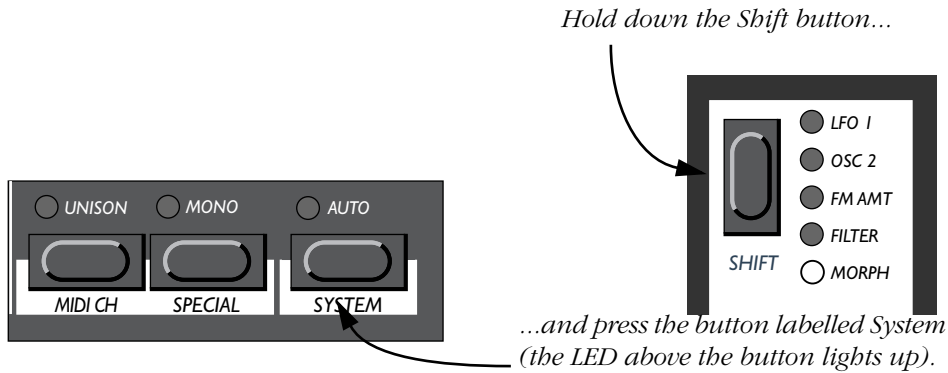

3. Press the System button repeatedly until the character to the left in the display says “b” (for Bend).
4. Use the Program Up/Down buttons to the left of the display, to change the value.  
The table on page 66 shows you how many semi-tones each value in the display represents.

---

If the Pitch Stick should be malfunctioning on startup, the display will scroll the message “PITCH BEND ERROR.”. The Nord Lead will then work as usual, but the Pitch Stick will be disabled.

---

### Modulation Wheel

The effect of moving the Modulation wheel can be different for each Program. You can change the function by pressing the button just above the Modulation wheel. It steps between five possibilities. A description of each can be found on page 52.

## MASTER TUNE

To tune the Nord Lead to other instruments, proceed as follows:

1. Hold down the Shift button.
2. With the Shift button down, press the button labelled Tune.

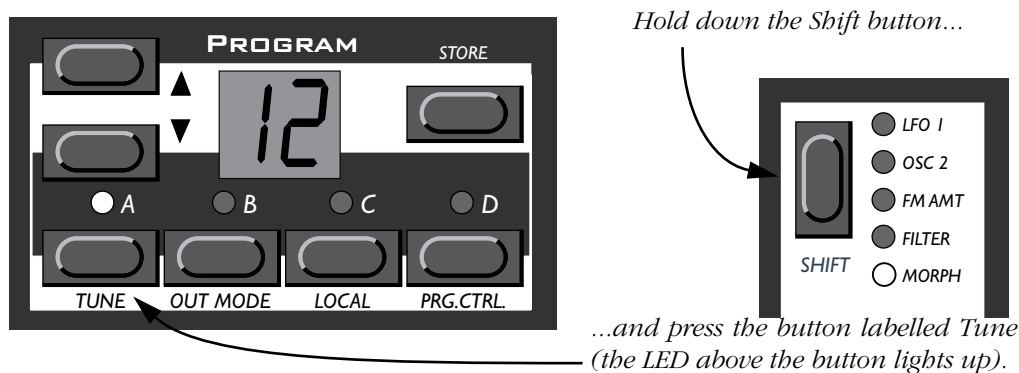

3. Use the Program Up/Down buttons to the left of the display, to change the value.  
00 is normal 440Hz tuning. Lower pitches are indicated by a dot to the right of the number and values higher than normal pitch are indicated without a dot. The values are in cents (hundreds of a semitone).
4. Press the Shift button again.

## PEDAL

As shown in the picture on page 8, the Pedal input accepts either a foot switch or an expression pedal. The procedures for setting up and using a connected foot pedal differs depending on the pedal type:

### *Using a Foot Switch*

A connected foot switch works as a sustain pedal. Set it up as follows:

1. Hold down the Shift button, and press the “System” button.
2. Press the System button until the left digit in the display is “P”.
3. Use the Program Up/Down buttons to switch the right digit between “1” (Sustain pedal – closed when pressed) and “2” (Sustain Pedal – open when pressed).
4. Press the Shift button again.

### *Using an Expression pedal*

As indicated in the illustration on page 8, a regular expression pedal can be connected using a stereo cable. The connected pedal will either duplicate the Modulation wheel or independently control one of a number of parameters. Set it up as follows:

1. Hold down the Shift button, and press the “System” button.
2. Press the System button until the left digit in the display is “P”.
3. Use the Program Up/Down buttons to switch the right digit to “E”.  
This tells the Nord Lead that the connected pedal is supposed to be an expression pedal. Now it’s time to assign a control function for the pedal:
4. While holding down the Shift button, press the Special button.
5. Press the Special button repeatedly, until the left character in the display is an “E” (for “Expression Pedal”).
6. Select a slot for which you want to set the pedal function by pressing one of the buttons A to D.
7. If you want the connected pedal to duplicate the functionality of the Modulation wheel, press the Program Down button until the right character in the display is a dash (“-”).



*With this setting, the expression pedal will have the same function as the Modulation wheel.*

8. If you instead want to select an independent control function for the pedal, press Store. The display will flash, showing one of the abbreviations in the table below.

9. Use the Program Up/Down buttons to select one of the following control functions:

Display shows:	Pedal assigned to:
L1	LFO 1 Amount.
L2	LFO 2 Amount.
F1	Filter Cutoff Frequency.
Fn	FM Amount.
02	Oscillator 2 Pitch.

10. After you have made your choice, press Store again.

You return to the “E” display.

11. Use the Program Up/Down buttons to select a control amount value (“1” to “7”).

This value (shown to the right of the “E” in the display) determines the range of the pedal control signal. Lower values give a smaller difference between the pedal’s “full up” and “full down” states. High values give a big difference between the pedal’s up and down states.

12. If needed, repeat steps 5 to 10 to set pedal control function for the other slots.

13. Press Shift to exit the Special menu and return to play mode.

---

No matter which function is selected for the Pedal input (“E”, “1” or “2” on the System menu), the Nord Lead will recognize Sustain and Expression pedal messages via MIDI (Controller message 64 and 11, respectively). For example, it is possible to connect a regular sustain pedal to the Pedal input on the Nord Lead, and simultaneously accept Expression pedal messages via MIDI, controlling a parameter assigned as described above.

---





## 4. EDITING PROGRAMS

### CHANGING AN EXISTING PROGRAM

Actually, how to change a programmed sound can be described in one sentence: “twist the knobs and press the buttons”. It *is* as simple as that!

- ▼ For information about editing Percussion Kits, refer to page 30.
- ▼ Don't be afraid to edit and overwrite the RAM Programs in the internal memory (Program 01 - 40). If later you want to restore any of the original RAM factory programs, they are backed up as ROM Performances as described on page 106.

### CHANGING ONE SOUND IN A LAYER

If you have layered sounds you can still edit one of the sounds from the front panel. Proceed as follows:

1. Press the Program Slot button that you want to edit.  
Its LED will flash to indicate it is the *active slot*.
2. Use the front panel to change the sound.

### GETTING BACK TO THE PROGRAMMED SOUND

If you have edited a Program and want to get back to the programmed original, proceed as follows:

1. Select another Program for that slot.
2. Select the first Program again.  
It will now have reverted back to the way it was when you selected it last.

## USING MANUAL MODE

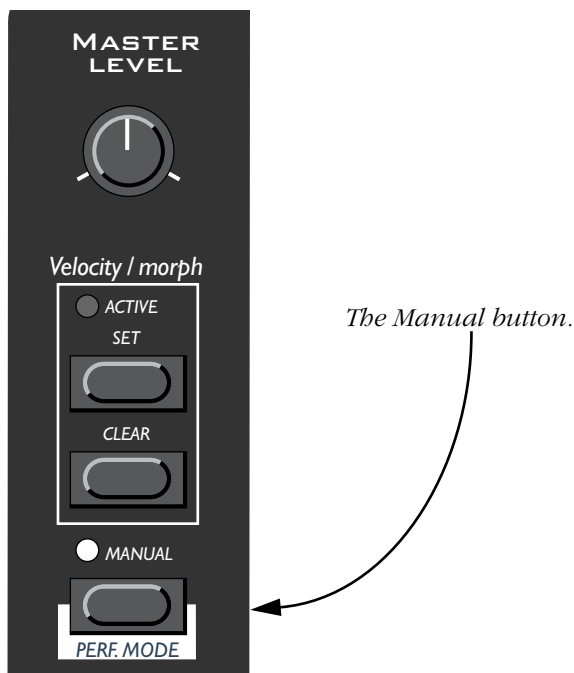

If you want to use the front panel to make up a sound from scratch, press the Manual button. This leaves you with exactly the sound that the knobs and buttons on the panel indicate (just as if the Nord Lead was an old non-programmable instrument).

When you press the Manual button, the instrument only plays one Program, layering is not possible.

## CUSTOMIZING MANUAL MODE

When you press Manual mode, the button functions (waveform select, modulation destinations etc.) will be set to some default values, for a basic sound. However, if you would like Manual mode to be different the next time you turn on power, proceed as follows:

1. Enter manual mode.
2. Set all button functions as you want them.
3. Press Store twice.



## STORING PROGRAMS

Storing is done identically regardless if you are saving an edited Program or if you are saving from Manual mode.

---

Saving a Program will permanently overwrite an existing Program. Be careful so that you don't accidentally erase a Program you'd like to keep! However, there is no danger of permanently losing the Factory Programs in RAM locations 01-40, since these are backed up as ROM Performances (see page 106).

---

**1. Press the Store button.**

The display flashes.

**2. Use the Program Up/Down button to select a Program number.**

You can play the now selected Program, in this mode, to decide if you want to replace it or not.

---

Only Program numbers up to 40 in internal memory Bank can be used for saving!. If you try to save in higher program numbers, nothing will happen!

---

**3. If you change your mind at this point, press the Program Slot you want to return to or press the Manual button to return to Manual Mode.**

**4. If you decide to go ahead with overwriting the existing Program, press Store again.**

The display stops flashing to indicate the Program has been saved.

## COPYING PROGRAMS

Copying Programs between memory slots is just a variation on Storing:

**1. Select the Program you want to copy.**

**2. Press Store.**

**3. Use the Program Up/Down button to specify the memory location you want to copy the program to.**

**4. Press Store again.**

## USING PCMCIA CARDS

If you have the eight voice expansion card installed in your Nord Lead, you can use a standard PCMCIA computer memory card in the slot at the back of the instrument. This allows you to save another three Banks for a total of 297 programmable memory slots and 30 programmable Percussion Kit locations, and 100 Performances (which in practice includes an additional 400 Programs). PCMCIA cards are also perfect for “backing up” (making safety copies of important Programs and Performances).

You can purchase Clavia cards at your Nord Lead dealer. These come with sounds for your instrument, but can be used to store your won. Ask your dealer for the Nord Lead Sound Library Series.

If you purchase the card at a computer retailer you should ask for this: *A 64 kilobyte S-RAM-based, battery-backed PCMCIA card.* There are cards with larger memory capacity than 64 kByte but using one with the Nord Lead is simply a waste of money.

### *Formatting of New Cards*

For the Nord Lead to be able to use a new PCMCIA card, it has to be formatted. The instrument will do this for you, if you perform the following steps:

1. **Check that the card is not write protected.**  
This is done with a switch located directly on the card.
2. **Insert the card.**  
The display will flash with the letters “Fo”.
3. **To format the card, press Store.**

### *Storing Programs On the Card*

This is nothing different from storing into the internal memory Bank. When specifying where to store Program, simply select one of the memory slots above “99”, as when selecting Programs from the card (see page 11).

### *Storing Performances On the Card*

This is described on page 35.

---

Before storing, make sure the card is not write protected. If it is write protected, the display will not stop flashing when you press Store the second time, to indicate the Program hasn't been stored.

---

### *Updating Older Cards*

A number of new parameters were introduced with the Nord Lead Software version 2.x. If you have a PCMCIA S-RAM card formatted with a previous Nord Lead software version, you need to update the card to be able to properly save settings for the new parameters. This updating procedure will not erase or alter any sound already on the card. Proceed as follows:

1. **Check that the card is not write protected.**
2. **Insert the card.**  
The display will flash with the letters “UP”.
3. **To update the card, press Store.**

# 5. PROGRAMMING VELOCITY SENSITIVITY

## THE FILTER VELOCITY FUNCTION

*Press this button to make the Filter Envelope Amount respond to velocity.  
The LED indicates that the Velocity function is activated.*

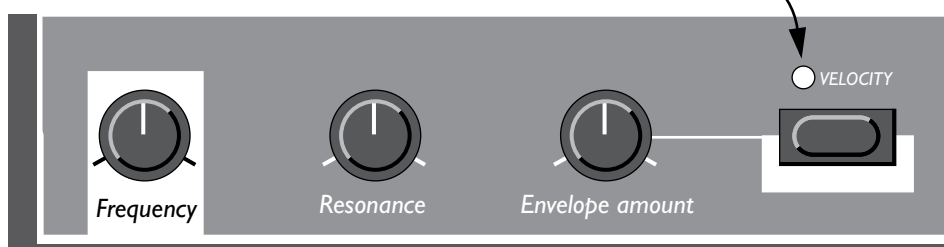

The quickest way to make a Program velocity sensitive, is to activate the Velocity function in the Filter section. This makes the Filter Envelope Amount vary with striking force, to a pre-determined degree. See page 46 for details.

## MAKING ANY PARAMETER VELOCITY DEPENDENT

You can make any continuous parameter (those controlled with knobs) react to velocity. You can also set the maximum and minimum boundaries for this, yourself.

### *Setting The Range*

1. Set the parameter to the value you want it to deliver when you play with minimum force.
2. Press the Active Set button in the Velocity/Morph section.  
The LED over the button will flash, indicating that the Nord Lead is in “Velocity Learn” mode.
3. Turn the knob to the value you want it to have at maximum striking force.  
You can try out different settings for maximum velocity until you find the most suitable. While the Nord Lead is in “Velocity Learn” mode, you can set ranges for as many parameters as you wish.
4. Press the Velocity/Morph button again.

The Velocity/Morph LED is now lit to indicate that at least one parameter in the sound is velocity dependant. What you have done now is to set the *range*, the span within which the parameter will change with velocity.

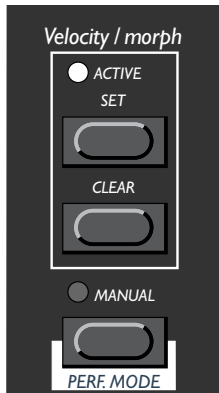

*If you press the Velocity/Morph button...*

*...and move a knob from here to there...*

*...this range will be the one that the parameter varies within.*

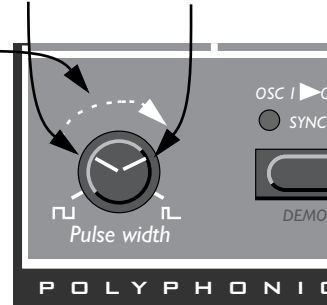

5. Turn the knob back to the value you want it to have when you play with minimum force. What you did now was moving the entire range, as described below.

*Set the value you want the parameter to have when you play with minimum force.*

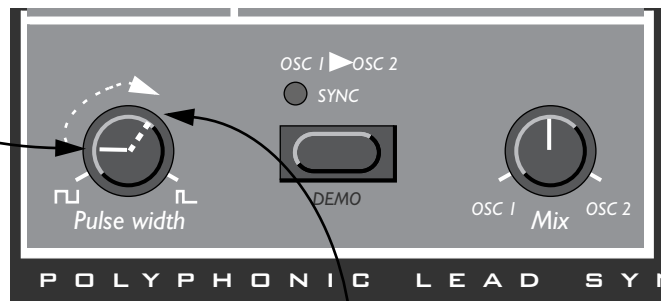

*If you have set the range as described in the previous picture, the value you get when playing with maximum force will be this.*

6. Play the Program to try out the effect.

Please note that any two values can be used when setting the range. To make a parameter value decrease when you play with more force, i.e. have “reversed” velocity response, simply use a low value for the “maximum force” setting and a higher value for the “minimum force” setting, when you are defining the range.

## Moving the Range

As explained above, step 1 to 4 sets the range of the parameter, how far it should be between the minimum and maximum values.

If you then turn a knob that has been programmed for velocity sensitivity, without holding any buttons or anything, you will adjust the minimum value only and the maximum value will move with it, accordingly.

*If you adjust the value for a parameter programmed for velocity control, you move the entire velocity control range up/down:*

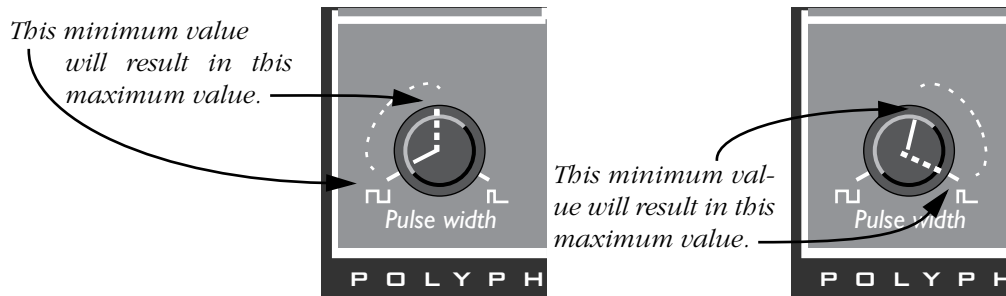

## CLEARING VELOCITY PROGRAMMING FOR ONE KNOB

1. Turn the knob to its lowest value.
2. Press the Velocity/Morph button.
3. Turn the knob a bit up and then back to its lowest value.
4. Press the Velocity/Morph button again.  
The Velocity/Morph function is now cleared for the knob.
5. Turn the knob back up to any desired value.

When velocity programming is cleared for all knobs, the Velocity/Morph LED goes out.

## CLEARING ALL VELOCITY PROGRAMMING

To clear all velocity programming, press the Clear button in the Velocity/Morph section.

## MORPHING

Morphing is a term used to describe a continuous blend or “transfer” between two images, sounds or similar. As described above, Nord Lead’s Velocity/Morph function is normally controlled by velocity. But you can route the function to the modulation wheel instead which allows you to continuously fade between two sounds – morphing!

The only thing you have to do to activate morphing for a sound that’s already set up for velocity control is to press the Mod Wheel destination button until all the LEDs for the Mod Wheel destination go out.

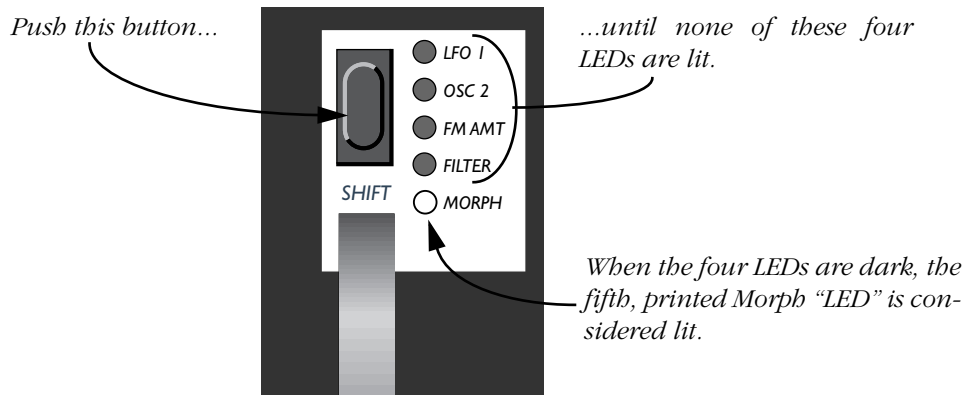

However, if you are setting up a Morph sound from scratch, we recommend the following procedure:

1. Press the Mod Wheel destination button until all the LEDs for the Mod Wheel destination go out.
2. Make sure the Modulation wheel is all the way down.
3. Set up the basic Program as you want it.
4. Move the Modulation wheel all the way up.
5. Press Velocity/Morph button and adjust the knobs so that the Program sounds the way you want it at “the other end” of the Morph.
6. Press Velocity/Morph again.
7. Play and move the Mod Wheel to try out the effect.

You can also use an Expression pedal for Morphing, see page 17.

---

Please note that the Velocity function in the Filter section can be used even if Morphing is active, so that a Program can be basically Velocity sensitive even though Morphing is activated.

---

## 6. PERCUSSION KITS

The Nord Lead Percussion Kits consist of eight different virtual analog percussion sounds, arranged in zones across the keyboard. They allow you to incorporate percussion patterns in your music without using up more than one Nord Lead Program Slot.

### SELECTING AND PLAYING A PERCUSSION KIT

1. Select the slot where you want the Percussion Kit.  
You can select Percussion Kits for all four slots if you like, giving you a total of 32 different percussion sounds available simultaneously.
2. Use the Program Up/Down buttons to scroll past Program number 99 and select one of the Percussion Kits. There are ten Percussion Kits in ROM, located directly after the “regular” Programs and labelled “P0” to “P9”. For example, select Percussion Kit P0.

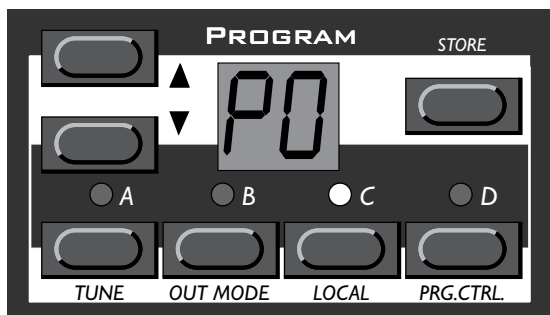

*Percussion Kit P0 selected in Program Slot C.*

3. Use the white keys to play the percussion sounds in the selected Kit.  
There are eight different percussion sounds in each Percussion Kit, arranged in zones across the keyboard like this:

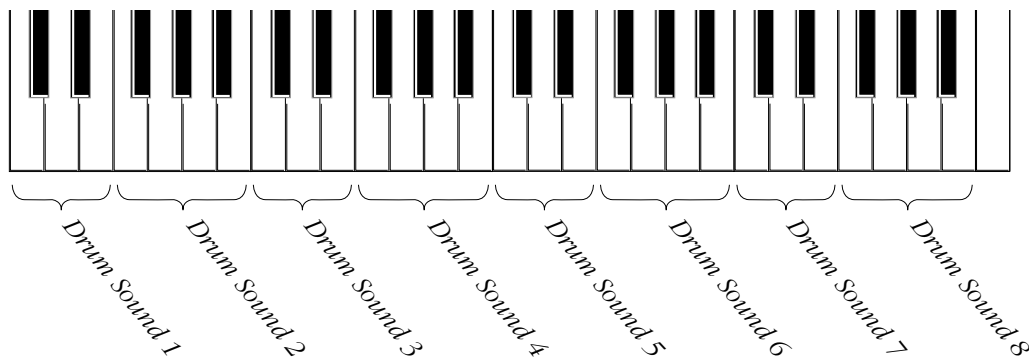

If you for example press the lowest keys F, G, A or B with Percussion Kit P0 selected, you will play a snare sound. A list of the ROM Percussion Kits and their sounds is supplied in page 100.

---

The keys in a zone will produce different pitches, just as if you played the sound as a regular Program. However, some percussion sounds are not programmed to respond to keyboard pitch.

---

## EDITING THE SOUNDS IN A PERCUSSION KIT

While the white keys are used to play the percussion sounds, the black keys are used for selecting which sound to make changes for:

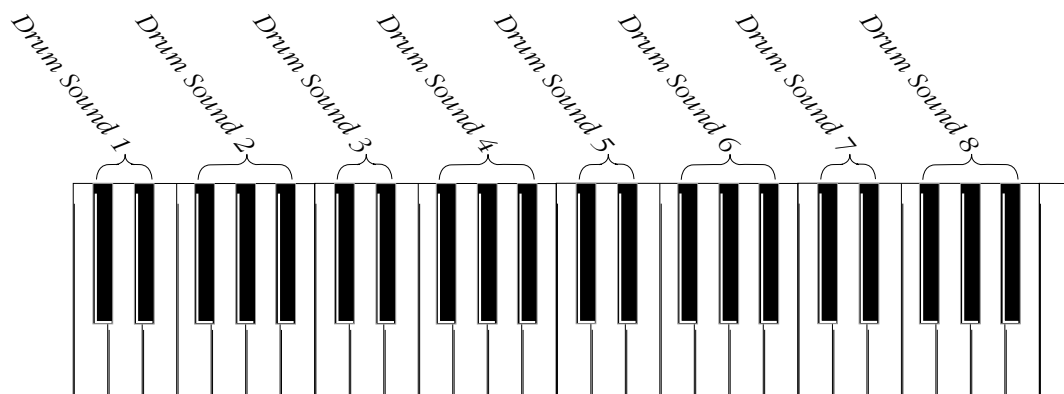

If for example you want to edit the snare sound in kit P0, proceed as follows:

1. Select Percussion Kit P0 as described on the previous page.
2. Press one of the keys F#, G#, A# in the lowest octave.  
The display will briefly show "-2", indicating that percussion sound number 2 is selected for editing.

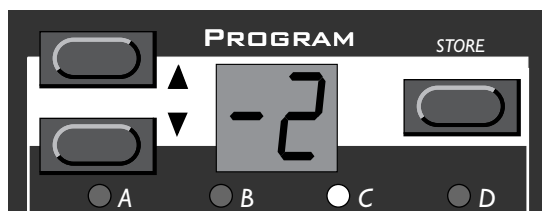

3. Now you can use the knobs and buttons on the panel to edit the selected percussion sound to your liking, just as in regular Nord Lead programs.  
You can play the other sounds freely while editing the selected sound, as long as you don't press any other black key (since this would select another sound for editing).

---

There is one limitation when programming the percussion sounds: All of the sounds in a Percussion Kit will share the same LFOs. The Nord Lead will use the LFO rate, waveform and destination settings of the last played percussion sound.

---

4. When you're satisfied with the first sound, press another black key to select another percussion sound for editing, according to the figure above.

---

Edited Percussion Kits cannot be saved in the ROM Bank of the Nord Lead. To save Percussion Kits, you can either use an optional PCMCIA S-RAM card or dump MIDI Sys Ex data to a sequencer or MIDI recorder (see page 71).

---



## COPYING, EXTRACTING AND IMPORTING INDIVIDUAL PERCUSSION SOUNDS

You can easily copy a percussion sound for use in another zone. This zone can be in the same Percussion Kit or in another one. You can also “extract” the percussion sound and save it as a regular Program.

---

If you want to copy the percussion sound to a zone within a Percussion Kit, the destination Percussion Kit must be on a PCMCIA S-RAM Card, since you cannot save any changes in the ROM Percussion Kits.

---

1. **Locate the zone of the percussion sound you want to copy/extract. Hold down a black key in this zone and press Store.**  
The display flashes.
2. **Scroll to the Program or Percussion Kit location to which you want to copy the percussion sound.**
3. **If you have selected a regular Program to save the sound in, just press Store again.**
4. **If you want to save the sound in a zone in a Percussion Kit, hold down a black key in the destination zone and press Store.**

You may also want to “import” a sound that is currently a regular Program, and use it as a part of a Percussion Kit. Proceed as follows:

1. **Select the Program and press Store.**
2. **Scroll to the Percussion Kit location to which you want to copy the sound.**
3. **Hold down a black key in the zone to which you want to copy the percussion sound, and press Store again.**  
Again, the destination Percussion Kit must be in one of the three Banks on a PCMCIA card.

## SAVING PERCUSSION KITS

As already stated, an edited Percussion Kit cannot be saved internally in the Nord Lead. To save your changes, you have to use a PCMCIA S-RAM card:

1. **After editing the percussion sounds, press Store.**  
The display flashes.
2. **Use the Up and Down buttons to select a Percussion Kit location in one of the Banks on the PCMCIA card.**  
In each of the three Banks on the card, there are ten Percussion Kits, located above program number 99 and labelled “P0” to “P9” like in the ROM Bank. As with regular programs on the PCMCIA card, dots are used to indicate which of the three Banks is currently selected (see page 11).
3. **Press Store.**  
The edited Percussion Kit is saved at the selected location on the card.

## SYS EX DUMPS OF PERCUSSION KITS

You can transmit and receive Sys Ex data that contains all settings for a single Percussion Kit, just as for a regular Program. However, there are a couple of things to note:

- ▼ You've got to initiate the dump from Program Mode, not from Performance mode!  
If you make a Sys Ex dump from Performance mode, the actual parameters of the Percussion Kit will not be included in the dump, only a reference to which Percussion Kit is used in the Performance.
- ▼ Before receiving a Percussion Kit data dump, you must select a Percussion Kit for the "receiving" slot.  
If you attempt to receive a Percussion Kit into a slot which plays a regular Program (1-99), nothing will happen. Likewise, you cannot receive regular Program Sys Ex data into a slot which plays a Percussion Kit (P0-P9).

## USING PERCUSSION KITS IN PERFORMANCE MODE

In Performance mode, there is one big difference between regular Programs and Percussion Kits:

---

A Percussion Kit in a Performance is only a reference to the original!

---

This means that if you edit the percussion sounds in a Kit in Performance Mode, you will in fact be changing the original Percussion Kit, and all Performances that use this Percussion Kit will be affected by the changes! If you want to use a Percussion Kit within a Performance, e.g. for use in a sequencer song, and want to be absolutely sure that you get the right percussion sounds every time you select the Performance, proceed like this:

1. Edit a Percussion Kit as desired
2. Save it on one of the Percussion Kit locations on a PCMCIA card.
3. Make the Performance refer to this Kit location.
4. Be sure not to use this certain Percussion Kit in any other Performance or other context, to avoid editing and changing it in any way.

# 7. PERFORMANCES

## WHAT ARE PERFORMANCES?

Performances allow you to call up four Programs at a time in a live situation, or to recall complete setups when sequencing via MIDI. The Nord Lead comes with 100 Factory Performances in ROM. Some of these make use of two, three or four slots, while some are single-slot Performances, effectively serving as extra ROM Patches. Please note:

- ▼ You can edit the selected ROM Performance as desired, but you cannot save your changes internally.
- ▼ To save an edited Performance, you need an expanded Nord Lead and an optional PCMCIA S-RAM card. On a card, there is room for 100 Performances, located after the ROM Performances, and indicated with a dot to the right of the digits in the display.
- ▼ You can transmit edited Performance data via MIDI Sys Ex, for storage in an external sequencer, etc.

---

If the Performance contains a Percussion Kit, only the *reference* to the Kit Location will be saved with the Sys Ex dump! To include the parameters for the Percussion Kit, you need to make a separate Sys Ex dump of the Percussion Kit, from Program mode (not from Performance mode).

---

- ▼ You can receive Sys Ex data for one Performance at a time into the edit buffer. If you for example use Nord Lead multitimbrally together with a sequencer, it is often practical to place a Sys Ex Performance data dump in the beginning of your song, to select sounds, initialize global settings, etc.

The Factory Performances include several life-like drawbar organ simulations, created using a special “pseudo-additive” synthesis method. Some of the sounds include famous sound artifacts such as “hum” and “click” as well as rotating speaker effects, accomplished with Nord Lead’s Morph function. Among the Performances you can also find recreations of over 40 original factory patches from the classic vintage synthesizer Prophet 5. Sounds and applications are described on page 102.

Later in this text follows a detailed list of what settings are contained in a Performance.

---

To store Performances you need an expanded Nord Lead with a PCMCIA card inserted (see page 24).

---

## RECALLING A PERFORMANCE

When you recall a Performance, you replace the four current Programs in the slots A to D with the Programs in the Performance. You also recall other settings as listed in the table later in this chapter.

### I. Enter Performance mode by holding down Shift and pressing Performance (Manual).

The display shows the latest selected Performance.

The Performances are organised in 10 Banks, named alphabetically from A to L (the letters I and K are excluded because they’re hard to write clearly on the display). In each Bank there are 10 Performances, for a total of 100. If you have a PCMCIA card inserted, the Banks on the card are found after the internal (ROM) Banks and labelled in the same way, but indicated with a dot to the right of the digits in the display.

- If you want to select another Bank (A to L), hold down Shift and press the Up and Down buttons.
- To select a Performance in the Bank use the Up and Down buttons.  
The Performance is instantly loaded and you can try it out.

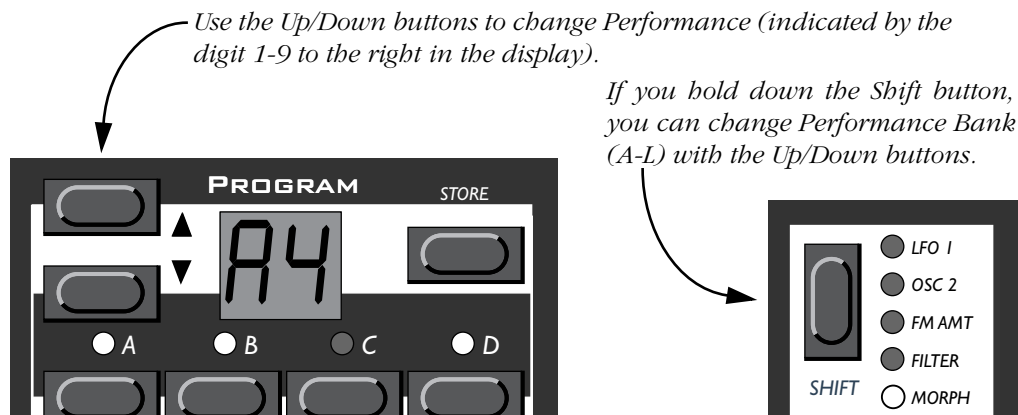

You can also select Performances via MIDI, see page 68.

---

Please note that selecting a new Performance changes a lot of parameters, including MIDI Channels and Special modes for each Program slot. This might lead to silent sounds!

---

## EDITING THE PERFORMANCE

### Selecting Programs

To replace a Program in a Performance, proceed as follows:

- Hold down the desired slot button (A to D).  
The display shows which Program was used for this slot, when the Performance was created.
- While holding down the button, select a Program for the slot, just as you would in “non-Performance” mode.  
See page 11.

Hold down the desired slot button (its LED will blink, and the display will show the selected Program for the slot).

Use the Up and Down buttons to select another program for the Performance Slot.

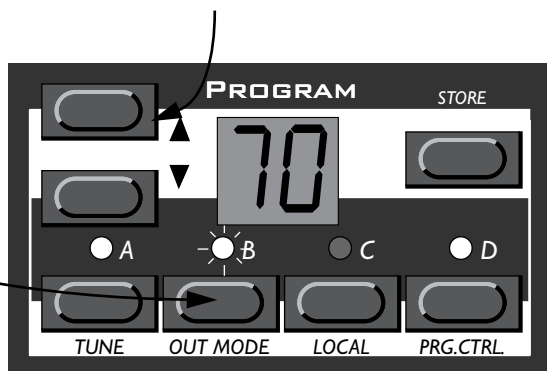

### **Layering and Editing**

This is done just as in “non-Performance” mode. The only thing to note is that when you save the Performance you save the edited Program(s) “inside” the Performance. The original Program that you used as a basis for the Performance is not affected.

---

This is not true for Percussion Kits, which are only referenced in the Performances. Any editing done to a Percussion Kit in Performance mode will affect the “original” Percussion Kit, and all references to it in other Performances.

---

### **Shift Functions**

Again, these parameters are set just as in non-performance mode. Most of these are also saved with the Performance as indicated in the table on the next page.

## **EXTRACTING SINGLE SOUNDS FROM A PERFORMANCE**

---

The text below does *not* apply to Percussion Kits in Performances.

---

As stated earlier, the sounds used in the Slots of a Performance are *not* references to regular, existing Programs, but complete Program Patches “in their own right”. You will find several unique sounds in the factory Performances, sounds that you will not find in any of the internal Program locations. You may want to extract such a sound, for use as a single Program, or to make it part of another Performance layer. Proceed as follows:

1. Select the Performance containing the sound you want to extract.
2. Make sure the Slot with the desired sound is selected (LED is flashing).
3. Press Store.
4. Hold down Shift and press the Perf Mode (Manual) button, to exit Performance mode.
5. Scroll to a suitable Program location (01 - 40 in the internal memory or any location on a PCMCIA card) and press Store again.

The sound is stored as a regular Program. This can now be played as usual, or included in another Performance as described on the previous page.

## **SAVING A PERFORMANCE**

---

To be able to save edited Performances, you need an expanded Nord Lead with a PCMCIA S-RAM card inserted.

---

1. Set up the Performance as desired.
2. Press the Store button.  
The Program display flashes.
3. Select one of the Performance memory slots, as described above.

4. If you change your mind at this point, press any of the Program Slot buttons.
5. If you decide to go ahead with overwriting the existing Performance, press Store again.  
The display stops flashing to indicate that the Performance has been saved.

---

Programs in Performance Slots are actually saved complete with all parameter settings when the Performance is saved. Percussion Kits, on the other hand, are only saved as references to existing Percussion Kits.

---

The above point means that there is no need to store the *Programs* separately. As soon as you save the Performance, all Programs that it uses are also saved, inside the Performance. This also means that if you later change any of your Programs, from Program mode, the Programs in the Performances are not affected in any way.

On the other hand, *Percussion Kits* need to be saved separately.

## EXITING PERFORMANCE MODE

1. To exit Performance mode, hold down Shift and press Performance (Manual).

Now you return to the regular Program mode. You will note that the four slots now play the four Programs that were selected before you entered Performance mode. Likewise, Layering and Shift functions are restored to the way they were set before you entered Performance mode.

## WHAT A PERFORMANCE CONTAINS

The following is a list of what a Performance contains, that is, what you actually save and recall when you work with Performances:

### *For Each Program Slot*

- ▼ The selected Program complete with parameter settings *or* a reference to a Percussion Kit.
- ▼ The MIDI Channel setting
- ▼ The Special settings
- ▼ Expression pedal assignment
- ▼ Aftertouch assignment

### *For the Entire Instrument*

- ▼ The Layer configuration
- ▼ Which Program is active for editing
- ▼ The Pitch Bend Range setting
- ▼ The Out Mode setting
- ▼ The Unison Detune setting

## 8. PANEL REFERENCE

### OSCILLATOR 1

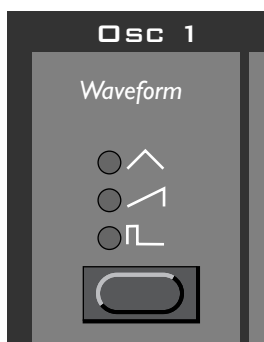

#### Waveform

This switches between one of three waveforms for Oscillator 1:

**Triangle:** This is a waveform with only odd and not very strong harmonics. It is suitable for flute sounds and similar.

**Sawtooth:** This contains all harmonics and is the richest of the available waveforms. It is suitable for all sorts of sounds.

**Pulse:** This waveform is special in that its harmonic contents can be varied continuously, by adjusting the Pulse Width, see below. The pulse wave can also be modulated by LFO 1. This waveform is suitable for many type of sounds, but has a more “hollow” character than the Sawtooth wave.

For an introduction to waveforms, see page 74.

## OSCILLATOR 2



### Waveform

The first three waveform alternatives for Oscillator 2 are identical to those of Oscillator 1, see above. But Oscillator 2 has one more waveform alternative:

**Noise and Noise Color:** With Noise selected, Oscillator 2 produces noise rather than a pitched waveform. The exact color (frequency contents) of the noise can be adjusted with the Oscillator 2 Tune knob.

The further you turn the knob clockwise, the brighter the noise will be. All the way to the right, its frequency characteristics is very close to that of white noise (where all frequencies are represented with equal energy).

---

Please note that the sound of the noise is affected by the filter setting (as all other sound from the Nord Lead). If the filter frequency is turned down, adjusting Noise color might not have the expected effect.

---

### Semitones

This setting is used to adjust the tuning of Oscillator 2, relative to Oscillator 1. The setting is in semitone steps. The range is from 5 octaves below Oscillator 1, to 5 octaves above Oscillator 1. However, the full range may not be available, depending on the Oct Shift setting (see page 54).

To aid you in setting the value, the LED above the knob lights up when the tuning is in perfect octaves.

### Fine Tune

This parameter is for tuning Oscillator 2, just as the Tune control is. The difference is that this parameter operates *within* one semitone.

If you set the two oscillators to equal volume (see Balance below), make sure Sync is turned off, set the two oscillators to the same Tune value, and raise or lower the Fine Tune Parameter slightly, the slight difference in Pitch will make the sound “richer”.

- ▼ The LED above the Semitone knob will flash briefly when you set Fine Tune to 0.



## Keyboard Track

When this parameter is *activated*, Oscillator 2 will have different pitches when you play different keys, just as Oscillator 1 always does.

When this parameter is turned *off*, Oscillator 2 will always play the same pitch. There are mainly three situations when this is useful:

- ▼ When Sync is activated (in this mode, the basic pitch of the sound is determined by Oscillator 1 anyway).
- ▼ When FM is used, to get inharmonic sounds with very varying timbre across the keyboard.
- ▼ For special effects and percussion sounds, which *are* supposed to sound the same all across the keyboard.

## SETTINGS FOR BOTH OSCILLATORS

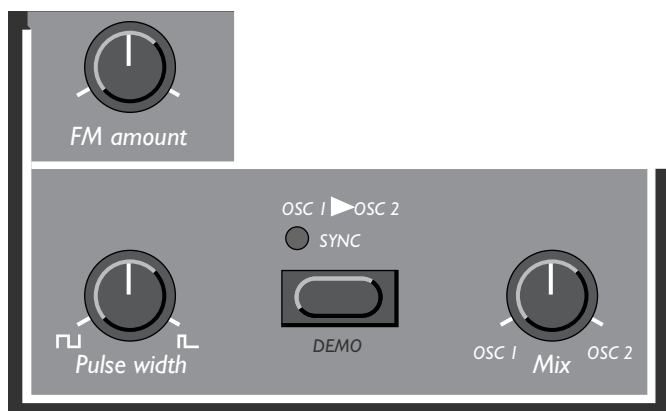

### FM Amount

This is classic “deep linear FM” as used in pure FM-based synthesizers. The FM function is a bit of a departure from the “analog” concept of the Nord Lead, but as you will find, it is a very useful addition.

In this FM implementation, OSC1 is being modulated by OSC 2. In FM speak, OSC 1 is the carrier and OSC 2 is the modulator. This, means that changing the pitch of OSC2 basically does not affect the pitch of the sound, but the timbre.

For classic FM sounds, use triangle wave on both oscillators.

**Modulation of FM Amount:** Please note that the amount of FM can be modulated from the Mod Env and also controlled manually from the Modulation wheel.

### Sync

When this switch is activated, Oscillator 2 is “synched” to Oscillator 1. This means that each time a period in Oscillator 1’s waveform starts, Oscillator 2 is forced to start over with a new period, as well. See page 78 for a more in-depth explanation.

The effect of this is that if Oscillator 2’s pitch is higher than Oscillator 1, its resultant waveform will have a pitch determined by Oscillator 1, but a timbre depending on the pitch of Oscillator 2. See page 78 for a basic explanation.

The easiest way to try this out is probably to activate Sync, and adjust the Tune setting for Oscillator 2 while holding down a note.

---

When trying out Sync, make sure you listen to Osc2, since it is this that is affected by the changes!

---

**Modulation of Oscillator 2 pitch:** Please note you can modulate the pitch of Oscillator 2 in various ways: from LFO 1, the Mod Env and from the Mod Wheel, for example. This can be used to create harmonically varying timbres with a very characteristic sound.

### Pulse Width

This setting only has any effect if Pulse wave is selected for either oscillator or both. It adjusts the pulse width of the Pulse waves.

There's only one Pulse Width setting, and it is common for both oscillators.

- ▼ When you turn the knob all the way to the left you get a perfect square wave which has a characteristic “hollow” quality.
- ▼ When you turn the knob clockwise, the sounds gets progressively thinner. See page 77 for a general introduction to pulse waves and pulse widths.

**Pulse Width Modulation:** Please note that the Pulse Width can be modulated by LFO 1. This creates a sweeping “chorus-like” effect suitable for pads and string sounds.

## AMPLIFIER

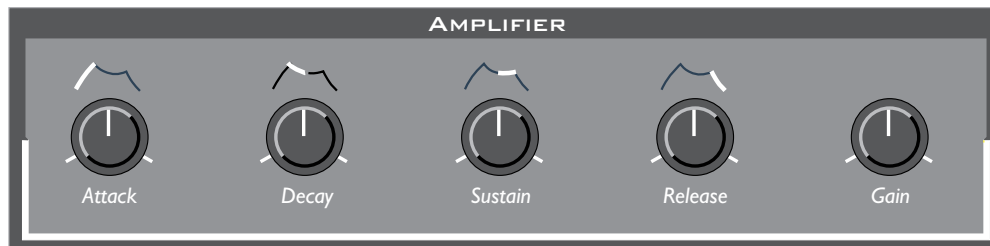

The Amplifier section is used to adjust the volume of the sound.

The Amplifier Envelope consists of the Attack Decay, Sustain and Release parameters. The Amplitude Envelope is used to give the sound it's basic shape (soft, slow, short, long etc.) for an introduction to envelopes, see page 84.

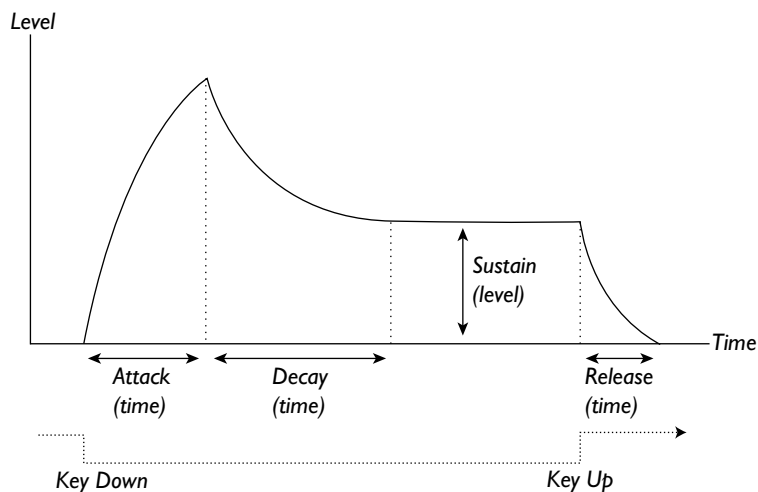

### Attack

This control is used to adjust how long it takes for the sound to reach full volume after a key has been pressed. If the knob is turned fully counter-clockwise, the Attack is instantaneous. If the knob is turned all the way to the right, it lasts many seconds.

### Decay

After the attack phase is finished (and you haven't released the key), the Decay begins. During the Decay phase, the sound decreases in level, and continues to do so until it reaches the Sustain level (see below). The Decay knob is used to adjust how long this should take.

### Sustain

This is the level the sound will reach after the Decay phase. Once this has happened, the sound will stay steady at this volume until the key is released.

---

Please note that the Sustain parameter is used to set a *level*, while Attack, Decay and Release all are used to set *times*.

---

### Release

This knob is used to adjust how long time it will take for the sound to decay to silence *after* you have released the key.

### Gain

This is used to adjust the overall Level of the Sound. This parameter is mainly used to balance one Program against another.

## FILTER

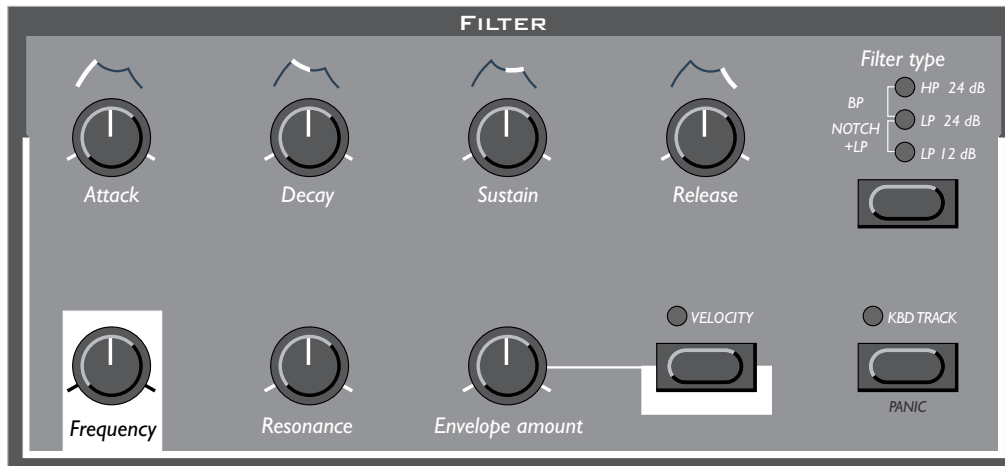

The Filter is the most important section for shaping the overall timbre of the sound. Nord Lead's filter can be switched between various *types*. It has the standard main Frequency and Resonance control. The Attack, Decay, Sustain and Release parameters make up the Filter Envelope. These, together with the Envelope Amount knob, can be used to make the Filter frequency vary as the sound progresses, when you press and hold a key.

---

For an introduction to filters, see page 79.

---

### Filter Type

**LP 12dB:** LP stands for low-pass. A low-pass filter lets low frequencies pass and cuts out higher frequencies. Exactly which frequencies get cut out is determined by the Filter Frequency setting (and various other controls, as described below).

In the 12dB low-pass mode, the filter has a gentle roll-off curve (12dB=2poles). This mode leaves more harmonics than the 24dB variation discussed below. This type of filter has been used in various Oberheim synthesizers and others.

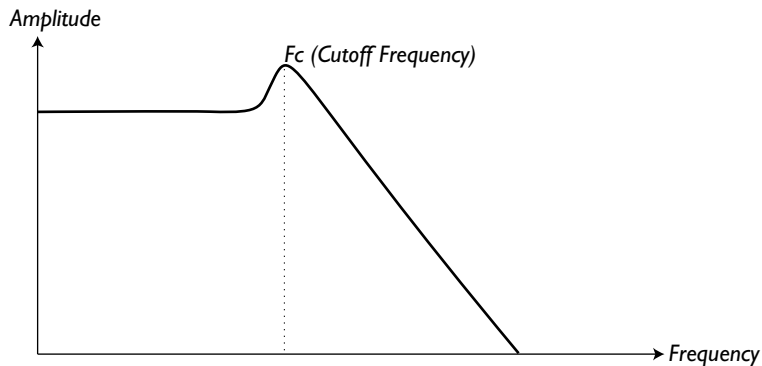

**LP 24 dB:** This is the classic synth filter used in the Minimoog and Prophet-5, among others. It cuts out high frequencies rather drastically (24dB=4 poles).

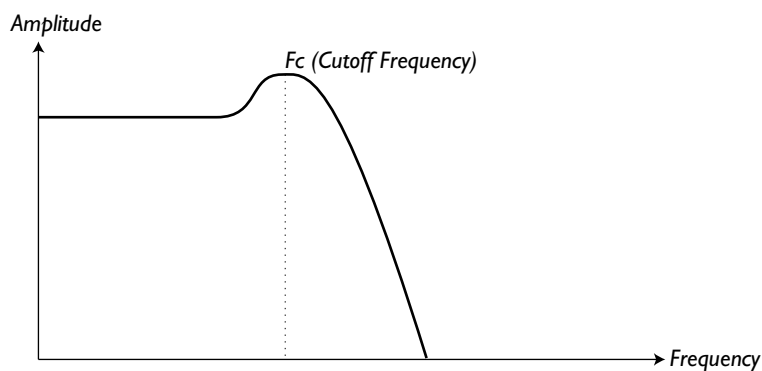

**HP 24dB:** HP stands for high-pass. This filter is the opposite of the lowpass filter, that is it lets the high frequencies pass and cuts out low frequencies. The filter has a rather steep curve.

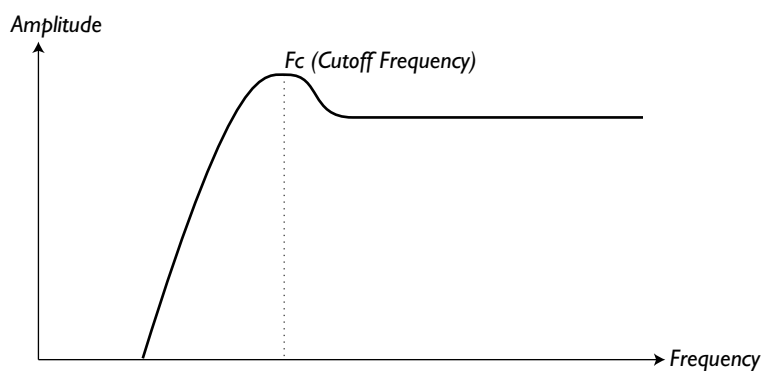

**BP:** To select this type of filter, press the Filter Type button until both the HP and LP 24 buttons light up.

BP stands for band pass. In this mode the filter let's frequencies in the "mid-range" band pass through, while lower and higher frequencies are cut out. Each "slope" in this filter has a 12dB (2-pole) roll-off.

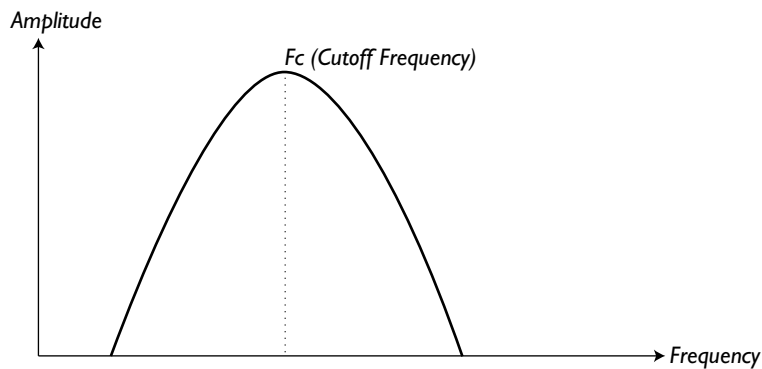

**Notch+LP:** To select this type of filter, press the Filter Type button until both the LP 12 and LP 24 buttons light up.

A notch (or band reject) filter can be seen as the opposite of a band pass filter. It cuts off frequencies in a “mid-range” band, letting the frequencies below and above through. However, a plain notch filter is not very musically useful, since it often lets too many frequencies through, resulting in a very sharp, harsh sound. Therefore, the notch filter in Nord Lead is combined with a 12dB Lowpass filter, resulting in a filter curve that looks like this:

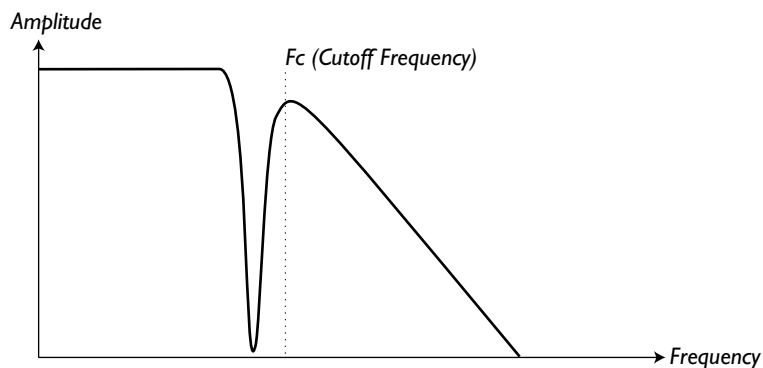

The audible result of this filter combination is a sound with plenty of body, some of the upper mid-range “bite” removed but a certain amount of high frequencies still present. This type of sound could be very useful for soft, yet clear pads, etc.

---

The special characteristics of the Notch+LP filter will be most obvious with low Resonance settings.

---

## Frequency

This is the overall control for which part of the frequency spectrum the filter should operate.

- ▼ If you for example select the 24dB filter and turn the Frequency knob clock-wise, more and more high-frequency material will be allowed to pass through the filter.

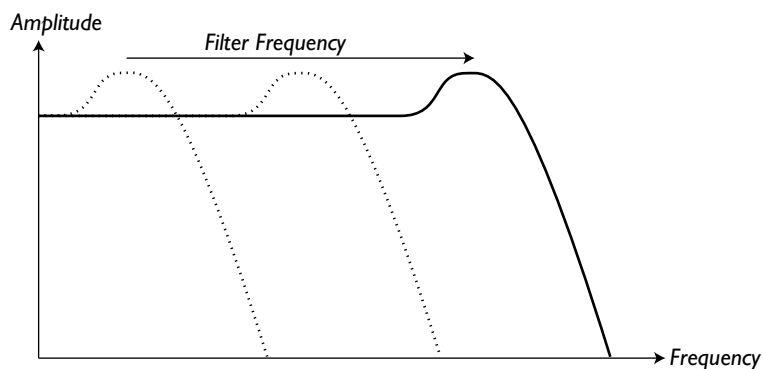

---

Please note that if the Envelope Amount setting is raised from its full left position, turning the Frequency knob might not change the sound as expected. For more information, see below.

---

### Resonance

This control is used to further adjust the characteristics of the Filter.

- ▼ If you are using the 12 or 24dB low pass filter, increasing resonance will emphasize frequencies around the set Filter Frequency, making the sound thinner. Further raising the knob will make the sound resonant to a point where the filter adds a ringing quality to the sound. Exactly where in the frequency spectrum this “ringing” appears, depends on the Filter Frequency setting.

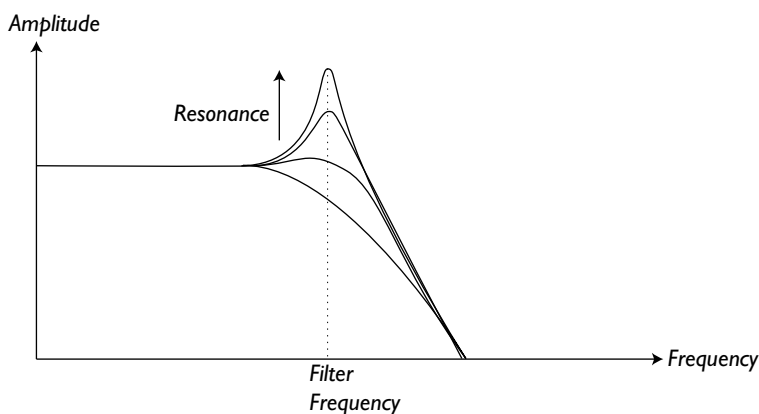

- ▼ If you have the high-pass or LP+Notch filter selected, increasing Resonance will work pretty much as with the LP filter.
- ▼ When you use the band-pass filter, adjusting the Resonance adjusts the width of the pass-band. When you raise the Resonance, the band where frequencies are let through, will become narrower.

### Envelope Amount

This is used to set to what degree the Envelope (see below) should affect the filter. The more you raise this knob, the more drastic the effect will be.

This knob operates in addition to the Filter Frequency setting. This means that if you for example set the Frequency knob half-ways, the filter will be already half-ways open the moment you press a key. The envelope will then be used to open the filter *further*. Exactly *how much* further is determined by the Envelope Amount setting.

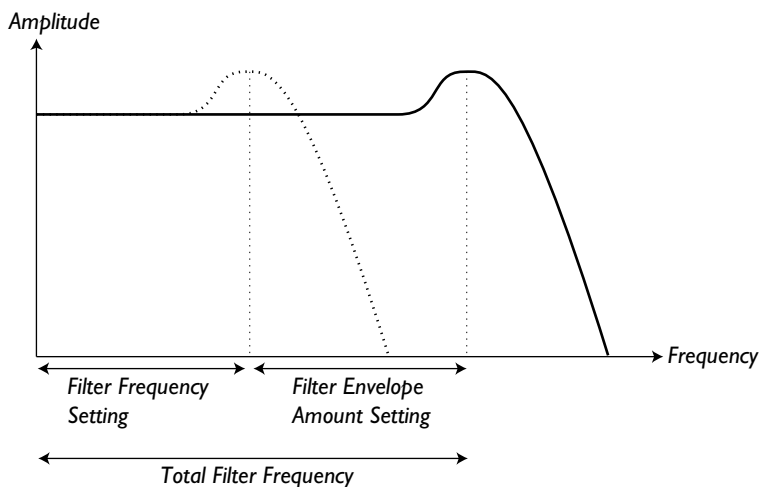

Let's take another example of the relation between Frequency and Envelope Amount: If the Filter Frequency knob is already turned fully right, the Envelope Amount setting has no effect at all, since the filter is already fully open the moment you press the key.

### ***Attack, Decay, Sustain and Release***

These are the parameters for the Filter Envelope. They are identical in functionality to the settings in the Amplifier Envelope, described on page 40.

### ***Velocity***

When this switch is activated, the Envelope Amount varies with Velocity (how hard you play the keyboard). For this switch to have any effect, the Envelope Amount setting can't be set to zero (full left).

---

Please note that more detailed velocity control can be achieved with the velocity programming function.

---

### ***Kbd Track***

- ▼ With this switch turned off, the Filter Frequency setting is constant regardless of where on the keyboard you play.
- ▼ When this switch is activated, the filter frequency setting will be higher for higher notes as indicated in the illustration below.

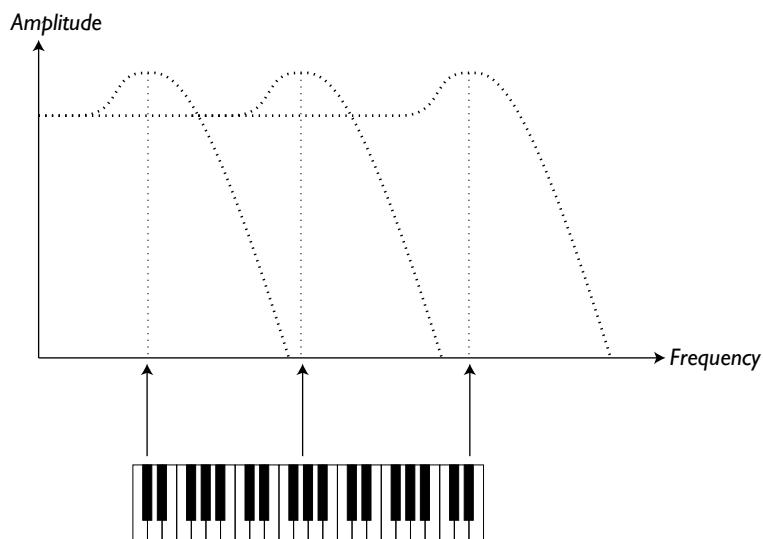

The reason for using this switch is related to basic acoustics. If you raise the pitch of a waveform, the harmonics naturally raise in frequency. If the filter frequency is then constant, the sound will be perceived as getting muddier the higher up the keyboard you play. To avoid this effect, use KBD Track.



## LFO 1

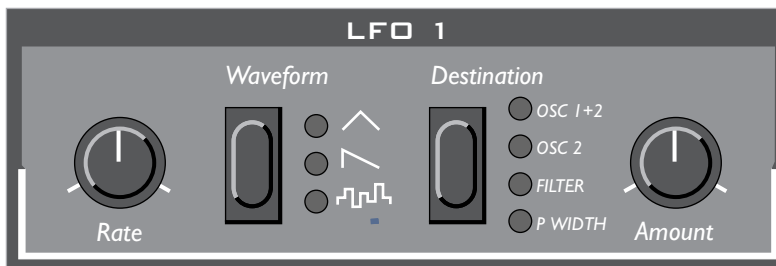

LFO stands for Low Frequency Oscillator. An LFO is an oscillator producing waveforms with a certain pitch, just like Oscillator 1 and 2. The differences are two:

- ▼ The LFOs produce waveforms with very low frequencies.
- ▼ You never hear the actual output of the LFO. Instead the output from the LFO is used for modulating, that is controlling other functions, like for example the main oscillator frequency (vibrato) or the filter frequency (wah-wah).

### Waveform

This is used to set the shape of the output from the LFO:

**Triangle:** This is suitable for “normal vibrato” effects and for classic pulse width modulation.

**Sawtooth:** This creates a ramp which can be used for example for auto-repeats when applied to the filter.

**Random:** This adds random modulation to the destination. This is mainly useful for effect sounds.

### Rate

This is used to set the frequency of the LFO, in other words “the speed of the vibrato”.

---

The rate can be controlled externally, via MIDI, see page 61.

---

### Destination

This used to set which parameter the LFO should affect:

**Osc 1+2:** This routes the LFO to the frequency of both oscillators, in equal amounts. Together with the triangle waveform this creates traditional vibrato.

**Osc 2:** This routes the LFO to the pitch of oscillator 2 only. This can for example be used together with Sync (see page 39) to create a “pulsating” change in timbre.

**Filter:** This routes the LFO to the Filter Frequency. This can for example be used for wah-wah effects (triangle wave) and for auto repeating sounds (sawtooth wave).

**P Width:** This routes the output of the LFO to the Pulse Width of both oscillators. For this to have any effect, pulse wave must of course be selected for at least one of the oscillators. This destination can be used with an LFO triangle waveform to create a “chorus-like” sound, suitable for strings and pads.

---

Please note that this function operates relative to the Pulse Width setting. For optimal results, please match the Pulse Width and LFO Amount settings (see below).

---

## Amount

This is used to set to what extent the signal from the LFO should be routed to the destination.

---

Please note that the Amount can also be controlled from the Modulation wheel, see page 52.

---

## LFO 2/ARPEGGIATOR



### Rate

- ▼ For conventional LFO effects (vibrato and tremolo), this is used to set how fast the LFO should run.
- ▼ When “Echo” is selected (see below), the Rate setting determines the “speed”, i.e. the delay-time between each echo. A higher Rate setting gives a faster echo (shorter delay-time).
- ▼ When arpeggio is selected (see below) this adjusts the speed of the arpeggio.

---

The LFO rate/arpeggio speed can also be controlled externally, via MIDI, see page 61.

---

### Destination

**OSC 1+2:** When this is selected, LFO 2 produces a triangle wave routed to the pitch of Oscillator 1 and 2 in equal amounts – in other words, a regular vibrato.

**Amp:** When this is selected, LFO2 produces a triangle wave routed to the volume, for tremolo effects.

**Echo:** In this mode (“OSC1+2” and “Amplifier“ LEDs lit), LFO2 creates an echo-effect by using repeated triggering with decreasing velocity (see explanation on the next page).

**Arp Up:** In this mode, LFO 2 works as an arpeggiator. The keys pressed on the keyboard will be played one after the other, from top to bottom, at a speed set with the Rate button. For more details, see Arp Range below.

**Arp Down:** As Arp Up but downwards.

**Arp Up/Down:** To get an up/down arpeggio, press the Destination button until both Arp Up and Arp Down are lit.

**Rnd Arp:** In this mode (“ARP Up” and “Amp” LEDs lit), Nord Lead will create random arpeggios from the chords you play on the keyboard. This means that the notes in the chord are played back one at a time, but in random order and in random octaves.

### ***Amt/Arp range***

- ▼ When Osc 1+2 or Filter is selected for destination, this knob is used to control the amount of vibrato.
- ▼ When Echo is selected, this knob determines the number of echo repeats (0 – 8).
- ▼ When any type of arpeggio is selected, this knob is used to set the octave range of the arpeggio, as the panel indicates. The Off position turns off the arpeggio completely.

---

You can select if you want the generated arpeggio notes to also be sent to MIDI Out. See page 59.

---

### ***About the Echo function***

It is important to understand that the Echo function is not the same as a regular audio delay! What happens when you play a note with Echo activated, is that the same note is triggered (played) again the set number of times, with gradually decreasing velocity. This has the following consequences:

- ▼ If the sound you are playing is not sensitive to velocity (Filter Envelope Amount Velocity and Velocity/Morph are both turned off) there will be no difference whatsoever between the echo repeats.
- ▼ On the other hand, it is fully possible to use the Velocity/Morph function to make the sound change completely with the echo repeats, making the function ideal for special effects.
- ▼ The echo consumes polyphony, i.e. each echo repeat “steals” one voice, just as if you had played the repeats from the keyboard yourself.  
This should not be a problem when using the echo effect with short sounds, but if you play long, sustained notes with echo, you could experience notes being cut off by the echo repeats. The solution is to lower the Amt setting (decrease the number of repeats) and possibly play shorter notes.
- ▼ The echo function may give unexpected results if you use another Play mode than Poly.  
For example, in Mono mode, each sustaining note will be cut off by the next echo repeat and in Legato mode, you may end up with no sound at all, since new notes will not re-trigger!

## MODULATION ENVELOPE



This is a simple type of envelope only comprising Attack, Decay and Amount controls.

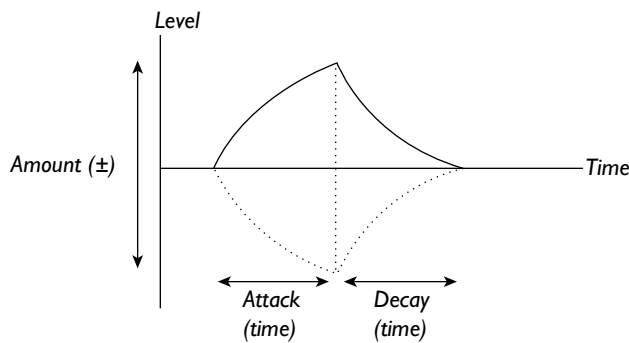

### Attack

This is used to set the time it takes for the envelope to reach “full level” after you have pressed a key.

### Decay

When the attack phase is over, the envelope drops back to zero level. The Decay knob is used to set how long this should take.

---

There's another difference between the way this envelope works compared to the other: It will start over from “zero” each time you press a new key, regardless of which value it had when you released the key.

---

### Amount

This is used to set to what degree the envelope should affect the destination. This knob is bi-polar, that is, zero amount is in the middle (twelve o'clock). Turning it left introduces a negative envelope and turning it right gives you a positive envelope.

### Destination

**None:** You can turn off both LEDs, to completely turn off the effect of the Modulation envelope. While this is the same as setting Amount to its centre position, this method is simply quicker.

**FM Amt:** When this is selected the envelope is routed to the amount of FM modulation. Varying the amount of FM changes the harmonic contents of the sound, so this can be used to have the timbre change pretty much like when the Filter envelope is used to change the Filter Frequency.

---

Please note that this parameter operates in addition to the FM amount setting in the Oscillator section.

---

**OSC 2:** When this is selected, the envelope changes the pitch of Oscillator 2. This can be used in a number of situations. For example:

- ▼ With Sync to create distinct sweeping sounds.
- ▼ With FM for effect type sweeps.
- ▼ To create “bleeps” in the beginning of a brass type of sound. Let us give a few examples:  
If Attack is set to zero, and you have a positive Amount setting, Oscillator 2 pitch will decay down to normal pitch as set with the Decay knob.

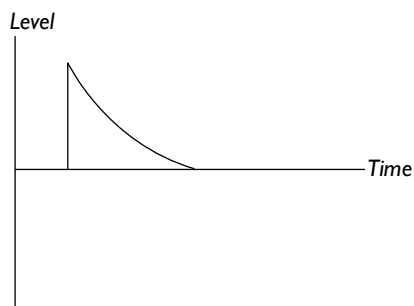

If Amount instead is set to a negative value, the pitch will rise up to “normal”.

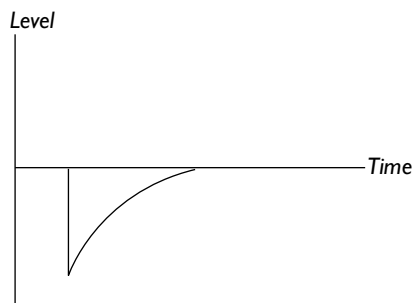

If Attack and Decay are both used and you have a positive Amount setting, the sound will start at normal pitch when you press the key, rise and then “fall back”.

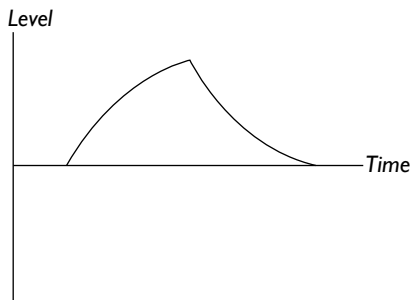

## MOD WHEEL DESTINATION

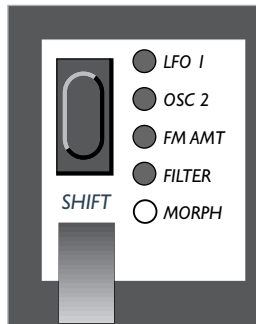

This is used to decide what effect moving the Modulation wheel should have.

### *LFO 1*

When this is selected, the Mod Wheel adjusts the amount of output from LFO 1. This allows you to for example add vibrato with the mod wheel.

### *Osc 2*

With this selected the Modulation wheel is directly routed to Oscillator 2 pitch. This can be used for example together with Oscillator Sync and FM to vary the timbre of the sound while playing.

### *FM Amt*

This routes the modulation wheel to the amount of FM (see page 39).

### *Filter*

This routes the modulation wheel directly to the filter frequency.

---

Please note that modulation wheel routing is in addition to the basic setting of the control it is routed to. If you for example route the modulation wheel to the filter, and the filter is already fully open, moving the modulation wheel has no effect.

---

### *Morph*

When no LED is lit, the modulation wheel is used for morphing. See page 28.

## POLY LEGATO MONO

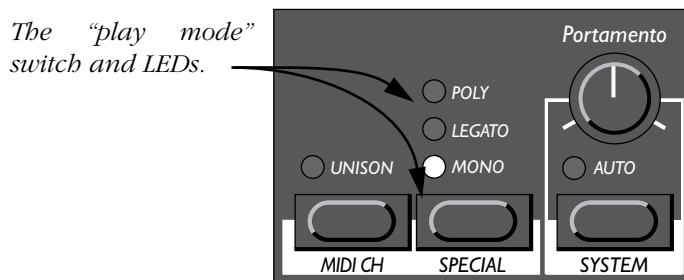

The “play mode” switch is used for deciding exactly how your keyboard playing should be interpreted by the synthesizer:

**Poly:** This mode allows you to play chords.

**Legato:** This makes the instrument monophonic. Furthermore, if you press a key without releasing the previous, the pitch will change, but the envelopes will not start over. That is, there will be no new “attack”.

**Mono:** This also makes the instrument monophonic. But if you press a key without releasing the previous, the envelopes are still retriggered, like when you release all keys and then press a new one. Furthermore if you press a key, hold it, press a new key and then release that, the first note is also “re-triggered”.

## UNISON

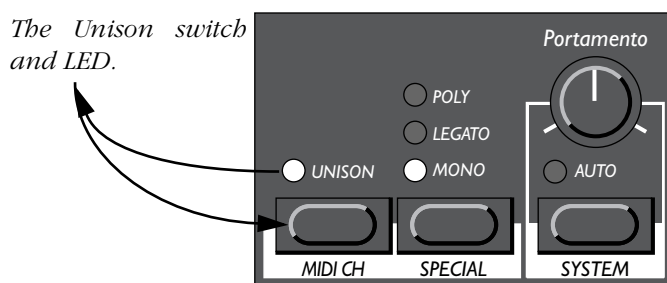

When this is activated more than one voice will be played when you press a key. This gives you a “fatter” sound, but at the same time reduces polyphony.

- ▼ If Poly mode is selected, two voices are used for each key. This allows you to play two notes at the same time, on a basic four voice instrument, and six notes on an expanded 12-voice instrument.
- ▼ If Mono or Legato mode are selected, four voices are used for each key. This makes the Program monophonic.

## PORTAMENTO

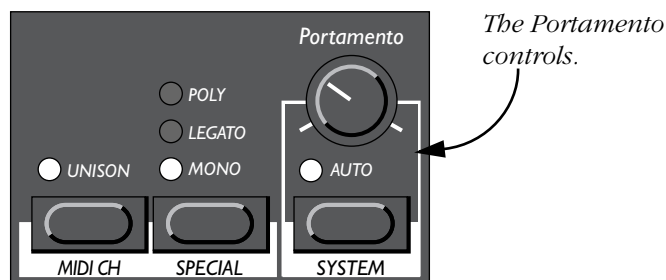

### Portamento (Time)

This is used to set how long it takes for the pitch to slide from one pitch to the next. If you don't want any Portamento at all, set this knob to zero.

### Auto

When this is activated (LED is lit), the pitch only slides if you play legato, that is if you play a new key before lifting the previous.

The effect of this switch is pretty obvious when you have selected Mono or Legato “Play mode”. If, on the other hand, Poly is selected, the Portamento effect will be slightly unpredictable if Auto is on, especially on a twelve voice synthesizer. For Poly mode, we therefore recommend you to turn Auto off.

## OCT SHIFT

The Octave Shift buttons have two functions, Slot and Keyboard Octave Shift (explained below). To switch between the two Octave Shift modes, simultaneously press both Octave Shift buttons and hold them pressed until the LEDs change indication mode, as shown in this figure:

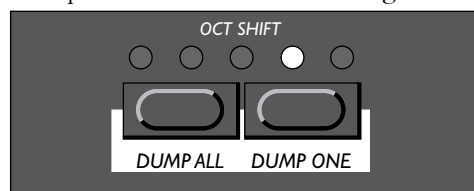

*Slot Octave Shift (default)*

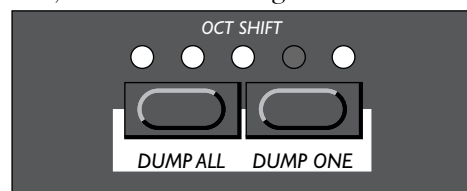

*Keyboard Octave Shift (LEDs inverted)*

### Slot Octave Shift

This mode will automatically be selected each time you turn on the Nord Lead. In this mode, the Octave Shift buttons affect the Program in the selected slot only. Notes sent to MIDI Out are not transposed. This means that in this mode, the Nord Lead can only send MIDI Notes over a range of 4 octaves.

### Keyboard Octave Shift

In this mode (LEDs inverted), the actual *keyboard* is affected by the Octave Shift buttons. This means that *all* active slots are affected, as well as all notes sent to MIDI Out. This mode is suitable if you want to control other MIDI instruments from the Nord Lead, since it lets you control a note range of eight octaves. It is also the mode to use if you're playing a Performance consisting of two or more slots, and want to be able to Shift all slots simultaneously.

---

Low/high octave settings in combination with extreme Tune settings for Oscillator 2 may produce pitches outside the hearing range.

---



# 9. SHIFT FUNCTIONS

## ACCESSING THE SHIFT FUNCTIONS

Some functions do not have dedicated buttons, but share buttons with other functions and settings. These are called the *Shift Functions* and are printed in blue on the front panel.

### Selecting a Shift Function

1. Hold down the Shift button.
2. Press any of the buttons labelled “Tune” to “System”.  
Most of the front panel LEDs go out and the program display now shows the selected function.

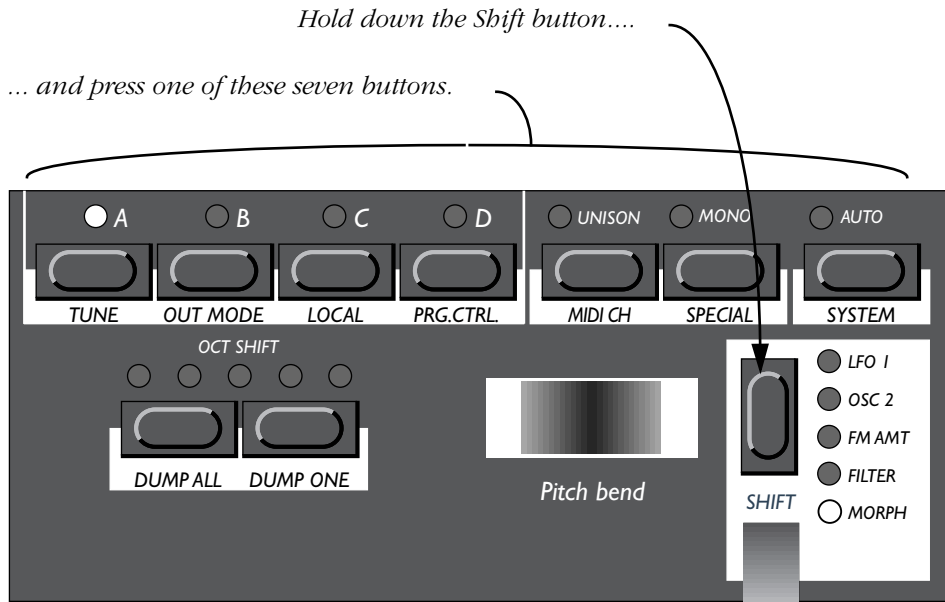

3. If the Function button you pressed is used for more than one parameter, press it repeatedly until the display shows the desired function.  
If you for example selected the “Prg.Ctrl” button, the left digit in the display switches between “P” (Program) and “C” (Controllers) when you press it.



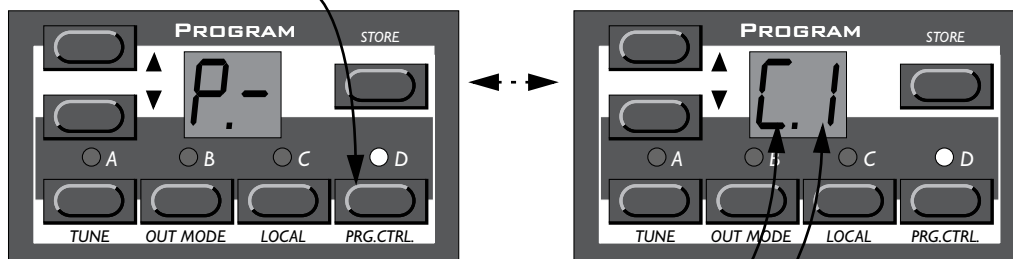





















Press the function button to switch between the possibilities. In this picture the Program (P) and Controller (C) functions.



When a Function button is used for more than one parameter, the two digits are separated by a dot. The first digit then indicates the parameter, and the second the value.

### Shift Function Listing

The table below shows you what Shift Functions are available for each of the seven buttons and an example of what the display might look like for each function.

 TUNE	 OUT MODE	 LOCAL	 PRG.CTRL	 MIDI CH	 SPECIAL	 SYSTEM
 Master Tune	 Out Mode	 Local On/Off	 Prog. Change On/Off	 Slot MIDI Channel	 LFO 1 Sync	 Pedal
			 Controllers On/Off	 Global MIDI Channel	 LFO 2 Sync	 Pitch Bend Range
			 Arp.MIDI Out On/Off		 Filter Enve- lope Trig	 Unison De- tune
					 Amplitude Env. Trig	
					 External Ve- locity Morph	
					 Aftertouch Assignment	
					 Exp. Pedal Assignment	

Each time you turn on Power, Local On/Off is set to On, and all the Special functions are turned off! (However, the Special settings are saved with the Performances).

### About Global and Slot Functions

- ▼ If the function you select can be set independently for each Program Slot (A to D), the selected Program slot flashes. To make settings for a certain slot, select it.
- ▼ If the selected function is global for all slots, the selected Function button is steadily lit. Which slot is selected is then of no relevance for the setting.

### Setting the Value

Once a function is selected, the value is set using the Program Up/Down buttons.

### Returning to the normal display

To go back to the regular functions, press the Shift button once again.

---

There is no need to store the Shift settings. The settings will automatically remain in memory. However, some functions are reset to default values when you turn off power, see the description of each function for details.

---

## TUNE (MASTER TUNE)

This is used to tune the Nord Lead to other instruments.

“00” is normal 440Hz tuning. Lower pitches are indicated by a dot to the right of the number and values higher than normal pitch are indicated without a dot. The values are in cents (hundreds of a semitone).

## OUT MODE

This function is used to set how the Outputs should be used for handling stereo and individual external processing of sounds.

---

The Out mode setting is global for the entire instrument, which means all Programs share the setting made here.

---

Basically there are three possibilities for how a sound appears in the outputs:

- ▼ The first is that a Program appears with equal level at both outputs, which is what we refer to as *mono*.
- ▼ The second option is that the voices (the keys you play) appear alternating between the left and right outputs, which we refer to as *stereo*. If you play chords in stereo mode, the sound will be spread out in the stereo image.  
When Unison is activated, more than one voice will be used each time you press a key, as described on page 54. If a Unison Program is played in stereo mode, each time you play a key you will get at least one voice at the Right output and at least one at the Left output, which will result in a “wide” stereo sound.
- ▼ The third option is that when playing several Programs at the same time, some Programs can appear at the right output only and some at the Left output only.

The Out Mode function can be set to one of four values:

**Mode 1:** In this mode, all sounds are mono (as described above), except if Unison is activated in which case the instrument automatically switches to stereo. If one Unison and one non-unison Program are layered, *stereo* is used.

---

Mode 1 is not recommended when using the Nord Lead multitimbrally since one Program can be set to Unison and another not, which might lead to a stereo image you might not expect.

---

**Mode 2:** This is a straight Mono mode. All Program always appear with equal level at both outputs.

**Mode 3:** This is a straight stereo mode. All Program always appear with voices alternating between outputs.

**Mode 4:** In this mode Programs assigned to slot A and C will appear at the Left output, while Program assigned to slot B and D will appear at the Right output. This mode can be used when it is desired to treat two sounds differently in an external mixer, for example in multitimbral MIDI work or when layering sounds.

## LOCAL

This is used to turn Local Control on and off.

- ▼ Local On is the normal Play Mode.
- ▼ In Local Off mode, the front panel actions and your keyboard playing are transmitted via MIDI, but are *not used to play the synthesizer directly*. MIDI Input, however, works normally.

This mode is used with sequencers, when the Nord Lead is used both for recording and playing back MIDI, and when the sequencer has a MIDI Thru function (sometimes called “Merge” or “echo-back”).

---

When you turn on power, the instrument is always in Local On Mode.

---

### ***About Local Control and Control Change Transmission***

The Local Control setting also affects the front panel.

- ▼ In Local Off mode the front panel controls can *not* be used to change the sound directly, they must be routed via MIDI, just as the keyboard.
- ▼ However, if you use the Prog/Ctrl function to turn off reception and transmission of Control Change messages altogether, the front panel controls *can* again be used to change the sound directly, since otherwise there would be no way to use the front panel controls at all.

## PROG/CTRL

This is used for setting how Program Change and Control Change MIDI messages should be handled, and for turning the Arpeggio MIDI Out feature on and off.

---

These parameters are Global for the entire instrument, that is, the settings are valid for all Performances and Programs.

---

To switch between the three different parameters, press the Prog/Ctrl button. The left character in the display switches between “P” (Program), “C” (Control) and “A” (Arpeggio).

For the two first parameters (“P” and “C”) you use the Program Select buttons to switch between “–” and “1”. The “–” value means that no data of that type is transmitted or received. “1” means that type of data is both transmitted and received. The Arpeggio MIDI Out feature requires some explanation:

### *Arpeggio and MIDI Out*

If you want to, generated arpeggios can be sent out as MIDI notes. This makes it possible to arpeggiate chords on connected synthesizers and sound modules, and to record arpeggios in a sequencer. You activate it using the Prg. Ctrl. menu:

**1. Press the Prg/Ctrl button to select parameter.**

The left character in the display switches between “P” (Program), “C” (Control) and “A” (Arpeggio).

**2. Use the Program Up and Down buttons to switch between “–” and “1”.**

▼ For the Program and Control parameters, the “1” setting means that the respective MIDI data is transmitted and received by the Nord Lead, while the “–” setting means that it is not.

▼ For the Arpeggio parameter, the “1” setting means that generated arpeggios can be sent out as MIDI notes. This makes it possible to arpeggiate chords on connected synthesizers and sound modules, and to record arpeggios in a sequencer.

With the “–” setting, the chord you play on the keyboard is sent to MIDI Out, regardless of whether the Nord Lead arpeggio is activated or not.

---

Be sure to turn the Arpeggio MIDI Out feature off if you are using Nord Lead in Local Off mode and/or in a “Thru-loop” with a sequencer, other MIDI instruments etc! Under such conditions, the Arpeggio MIDI Out feature will either prevent the instrument from sounding at all, or cause a MIDI feedback loop.

---

## MIDI CHANNEL

### *Program Slot MIDI Channel*

To set the MIDI Channel that a certain Program slot receives and transmits on, proceed as follows:

**1. Hold down “Shift” and press “MIDI Ch”.**

**2. The display shows the MIDI Channel for the active Program slot.**

**3. Select the Program slot you want to make settings for.**

The Program slot’s LED flashes.

**4. Use the Up/Down buttons to set the MIDI Channel.**

If you don't want the slot to respond to or send MIDI, set it to "Off" (display shows "oF").

For more information on Program slots and MIDI Channels, see page 69.

***Global MIDI Channel***

This is the MIDI Channel used for transmitting and receiving Program Change messages for switching between Performances. To set the Global MIDI Channel, proceed as follows:

1. Hold down "Shift" and press "MIDI Ch".
2. Press "MIDI Ch" again.  
The display now shows the Global MIDI Channel.
3. Use the Up/Down button to set the MIDI Channel.

For more information on the Global MIDI Channel, see page 69.

## SPECIAL

There are five special functions that make it possible to use MIDI for functions that have previously been reserved for users of analog modular synthesizer systems.

### Accessing the Functions

1. Hold down Shift and press Special.
2. Press the Special button as many times is need to make the left digit in the display show the desired function (“1”, “2”, “F”, “A” and “5”).
3. Select the Program Slot (A to D) that you want to make settings for.
4. Use the Program Up/Down buttons to set values (the right digit).

---

The Special Functions can be set up differently for each slot and each slot can use all and any of the Special functions at the same time, if desired.

---

### Function “1” – Synchronizing LFO 1 To MIDI Clock

For this to work you need to feed MIDI clock from a sequencer or similar into the MIDI In of the Nord Lead and activate Play in the sequencer so that MIDI Clock is actually transmitted.

The function synchronizes LFO1’s start to the incoming MIDI Clock so that the LFO starts over at certain intervals. Which interval to use is set with the parameter value:

Value	Description
--	No external Sync
1	Restart every other bar
2	Restart every whole note
3	Restart every half note
4	Restart every quarter note
5	Restart every eighth note
6	Restart every eighth note triplet
7	Restart every sixteenth note

---

Please note that this only makes the LFO *restart* at the specified note value. In between those restarts, the LFO runs at the rate set with the Rate knob.

---

Therefore, to “hard sync” the LFO to the tempo of the song when triangle or sawtooth waves are used, set the LFO rate as close to the tempo in the sequencer as possible. On the other hand, unusual Rate values can lead to interesting rhythmic effects.

When random is selected (or when the Arpeggio is used, see below), to “hard sync”, you only need to make sure the set rate is lower than the rate imposed via MIDI.

### **An Example of LFO 1 Synchronization**

1. Select a Program for slot A, that plays a “stable” sound with infinite sustain, for example a “string” or “pad” sound.
2. Lower the Filter Envelope Amount to 0.
3. Set the Filter Cutoff to “nine o’clock”.
4. In the LFO section, select a sawtooth wave, set destination to Filter and set the Amount to full value.
5. Play the keyboard.  
You should hear a repeating sound.
6. Hold down Shift and press Special.  
The display should show the setting for Special function 1.
7. Press the Program Slot button A.
8. Use the Up/Down buttons to set the value to “5” (eighth notes).
9. Make sure all other Special functions are turned off for this slot.  
Do this by pressing the Special button repeatedly and check that the left digit in the display is set to “–” for all Functions except “1”.
10. Press Shift again to return to “normal mode”.
11. Set up your sequencer (or other MIDI device) to transmit MIDI clock to the Nord Lead. Set the tempo to around 120 BPM and activate Play in the device so that MIDI clocks are actually transmitted.
12. Play the Nord Lead keyboard and adjust the Rate knob in the LFO 1 section.  
Start at approximately 12 o’clock and adjust until you get eighth notes that are in sync with the sequencer. If you raise the Rate slightly from this position you’ll get a shuffle 16th note repeat, etc.

### **Function “2” – Synchronizing LFO2/Arpeggio to MIDI Clock**

This works exactly as Special Function 1, only that it operates on LFO 2 and the Arpeggio instead.

---

Please note that the explanation about the relation between the LFO rate and the restart via MIDI Clock also applies to the Arpeggio.

---



---

This function will not be enabled when Echo is selected on LFO2.

---

### **Function “F” – External triggering of Filter Envelope**

This function can be used to trigger the Filter envelope via notes coming in via MIDI, instead of by playing the keyboard. The Filter envelope is triggered from its own MIDI Channel and note number(s), completely independent of the MIDI Channel used for defining which keys should be played. This can be used to play back preprogrammed rhythms in your MIDI sequencer while inputting the actual pitch(es) by playing the keyboard or via MIDI.

You can use the Program Select buttons to switch between “–” and “1”. The setting “–” means that the function is turned off and. “1” means that it is activated.



To set which MIDI Channel and possibly which MIDI note number to use for triggering, proceed as follows:

**1. Activate the function.**

In other words, set the display to “F.1”.

**2. Press Store.**

The display shows the MIDI Channel currently used. Set the value with the Up/Down buttons.

**3. Press Store again.**

The Displays shows which MIDI Note number is currently used. The numbers start at C0 (MIDI note number 24), and a dot between the figures indicates a sharp (#). For example, “F.3” means F#3. “Middle C” is indicated as “C3”.

The value “--” means that note number is ignored, that is all notes on the set MIDI Channel will be used for triggering. This value is found below all the “number values”.

### ***Guidelines for Using Filter Envelope Triggering***

- ▼ If you have notes transmitted from your sequencer that you want to use *only* for triggering the envelope, make sure the MIDI Channel you use for this function is not used by any of the Program slots
- ▼ Please note that if the Velocity function in the Filter section is activated, the velocities of the incoming MIDI notes are routed to Filter Envelope amount. This allows you to adjust the timbre of the sound with the velocity of the incoming MIDI notes.

### ***An Example of Filter Envelope Triggering***

1. Select a Program for slot A, that plays a “stable sound with infinite sustain, for example a “string” or “pad” sound.
2. Lower the Filter Cutoff to 0.
3. Raise the Filter Envelope amount and adjust the Filter envelope so that the sound has a short, snappy character.
4. Hold down Shift and press MIDI Ch. Set the MIDI Channel for slot A to 1.
5. Press each of the other Program slot buttons and set them to MIDI Channel 16.  
This is just to make sure they do not get used in this example.
6. Hold down Shift and press Special.
7. Press the Special button until the left digit in the display is “F”.
8. Make sure Program Slot A is selected. Otherwise press its button.
9. Use the Up/Down buttons to set the value to “1” (“on”).
10. Press Store. Use the Up/Down buttons to select MIDI Channel “2”.
11. Press Store again and adjust to “--” (any MIDI note number).
12. Press Store again.
13. Make sure all other Special functions are turned off for this slot.

Do this by pressing the Special button repeatedly and check that the left digit in the display is set to “–” for all Functions except “F”.

**14. Press Shift again to return to “normal mode”.**

If you play the keyboard now, you will not get any sound, because the Cutoff is all the way down, and the Filter envelope is no longer triggered by the keyboard.

**15. Set up your sequencer to play a simple repeating note pattern on MIDI Channel 2.**

The pitches of the notes does not matter, only the rhythm.

**16. Hold down a few keys on the keyboard and start the sequencer.**

The keys you press should be played with the rhythm from the sequencer.

### ***Function “A” – External triggering of Amplifier Envelope***

This function can be used to trigger the Amplifier envelope via notes coming in via MIDI, instead of by playing the keyboard. Just as with the previous function, this can be used to play back preprogrammed rhythms in your MIDI sequencer while inputting the actual pitch(es) by playing the keyboard.

---

You must play keys on the keyboard, or via MIDI (on the Program slot’s “basic” MIDI Channel), to get any sound!

---

The parameters are the same as for the Filter Envelope function, see above.

---

If this function is activated and no MIDI notes are triggering the Amplifier envelope, the instrument will be silent!

---

### ***Function “5” – External Velocity Morph***

This function is used to control the Velocity/Morph function via the velocity numbers of incoming MIDI notes.

This differs from the way Velocity/Morph is normally applied. Normally the velocity is applied each time you press a key. With the External Velocity Control function, however, you can press and hold notes and vary their timbre via the velocity of the incoming notes *without* releasing the keys (that is – without re-triggering the envelopes).

You can use the Program Select buttons to switch between “–” and “1”. The setting “–” means that the function is turned off and. “1” means that it is activated.

The velocity control happens on its own MIDI Channel and note number(s), completely independent of the MIDI Channel used for defining which keys should be played. It can be controlled from *all notes* on *one* MIDI Channel or *one specific note number* on *one* MIDI Channel (see Function 3 above for how to specify the MIDI note number and the MIDI Channel).

- ▼ When this function is activated, and a Note On message comes in, the parameters’ values are adjusted according to the note’s Velocity value.
- ▼ When a Note Off message comes in, the Velocity/Morph function is reset to the minimum value.

---

Please note that you must play the keyboard to hear anything. Also note that the Velocity/Morph must be set up beforehand for this function to have any effect on the sound.

---

## *An Example of External Velocity Morph*

1. Select a Program for slot A.
2. Edit the Program so that you get a morphing effect you like when you move the modulation wheel.  
It is not actually necessary to assign the velocity programming to the Modulation wheel, but it is a practical way to try out the effect before you apply it via MIDI.
3. Hold down Shift and press MIDI Ch. Set the MIDI Channel for slot A to 1.
4. Press each of the other Program slot buttons and set them to MIDI Channel 16.  
This is just to make sure they do not get used in this example.
5. Hold down Shift and press Special.
6. Press the Special button until the left digit in the display is “5”.
7. Make sure Program Slot A is selected. Otherwise press its button.
8. Use the Up/Down buttons to set the value to “1” (“on”).
9. Press Store. Use the Up/Down buttons to select MIDI Channel “2”.
10. Press Store again and adjust to “- -” (any MIDI note number).
11. Press Store again.
12. Make sure all other Special functions are turned off for this slot.  
Do this by pressing the Special button repeatedly and check that the left digit in the display is set to “-” for all Functions except “F”.
13. Press Shift again to return to “normal mode”.  
If you play the keyboard now, there will not be any velocity control because you have set the instrument up to only do this via MIDI.
14. Set up your sequencer to play a sequence of notes with drastically different velocity values.  
The pitches of the notes does not matter, only the rhythm and velocity.
15. Hold down a few keys on the keyboard and start the sequencer.

The sound should now vary in character with the velocity values coming out from the sequencer.

## *Aftertouch and Expression Pedal Settings*

The Special menu also contains settings for Aftertouch (“t”) and Expression pedal (“E”) parameter assignment. These functions are described in their respective contents on page 17 (Expression pedal) and page 67 (Aftertouch).

## SYSTEM

Under this menu you will find three different functions, labelled “P”, “b”, and “U”.

To select one of the functions, hold down Shift and press the System. Then press the System button repeatedly until the left digit in the display shows the desired letter.

### *Pedal (P)*

This is used to set how a connected pedal should be used. See page 17 for details.

This parameter is Global for the entire instrument, that is, the setting is valid for all Performances and Programs.

### *Pitch Bend Range (b)*

This allows you to set the range of the pitch stick, in semitones. The value is also used to set what effect incoming pitch bend messages should have on the pitch.

The table below shows you how many semi-tones each value in the display represents.

Setting	Range in semitones
1	±2
2	±3
3	±4
4	±5
5	±7

Setting	Range in semitones
6	±10
7	±12
8	±24
9	±48

This parameter is “global” for all Program slots. However, it is saved with a Performance.

### *Unison Detune (U)*

This allows you to set how far detuned the voices should be when you have Unison activated. For more info on Unison, see page 53.

This parameter is “global” for all Program slots. However, it is saved with a Performance.

# 10. MIDI

## ABOUT THE MIDI IMPLEMENTATION

The following MIDI messages can be transmitted and received from the Nord Lead:

### Notes

- ▼ Note On and Off messages are of course transmitted when you play the keyboard. If you use the Octave Shift buttons in their “Keyboard” mode (see page 54), you can shift the Nord Lead keyboard  $\pm 2$  octaves, giving you an effective keyboard range of 8 octaves.
- ▼ Notes can be received over the entire MIDI range. That is, when playing via MIDI you have access to a pitch range wider than 10 octaves!

### Pitch Bend

- ▼ Pitch Bend messages are always transmitted from the Pitch Stick.
- ▼ The Pitch bend range (used when receiving pitch bend messages) can be adjusted, see page 66.

### Controllers

- ▼ The Modulation wheel is transmitted and received via MIDI as Controller 1 (Modulation wheel).
- ▼ When the Pedal input is used with an Expression pedal, this is transmitted as Controller 11.
- ▼ When the Pedal input is used with a footswitch (sustain) this is transmitted as Controller 64 (Damper Pedal).
- ▼ All other controls (knobs and switches) on the front panel (except Master Level), are also transmitted and received as Control Change messages. This can be used to record your actions on the front panel into a MIDI sequencer, for playback together with the musical performance.  
For a full list of which parameters correspond to which Controller number, see page 89.

---

You can turn the transmission/reception of the front panel Controllers on/off, see page 59.





---

### Aftertouch

The Nord Lead can receive (but not send) Aftertouch (channel pressure) messages. For each program slot, you can set which parameter (if any) should be controlled by the Aftertouch messages:

1. While holding down the Shift button, press the Special button.
2. Press the Special button repeatedly, until the left character in the display is a “t” (for “touch”).
3. Select a slot for which you want to set the aftertouch function.
4. To assign a parameter for the aftertouch, press Store.  
The display will flash, showing one of the abbreviations in the table below.

5. Use the Program Up/Down buttons to select one of the following control functions:

Display shows:	Pedal assigned to:
	LFO 1 Amount.
	LFO 2 Amount.
	Filter Cutoff Frequency.
	FM Amount.
	Oscillator 2 Pitch.

6. After you have made your choice, press Store again.

You return to the “t” display.

7. Use the Program Up/Down buttons to select a control amount value (“-” or “1” to “7”).

This value (shown to the right of the “t” in the display) determines how much the assigned parameter should be affected by a received maximum aftertouch value.

---

If you don't want the slot to be affected by aftertouch messages, select amount value “-”.

---

8. If needed, repeat steps 3 to 7 to set aftertouch assignment for the other slots.

9. Press Shift to exit the Special menu and return to play mode.

### Program Change

---

The descriptions below are only true if transmission/reception of Program Change messages is activated, see page 59.

---

- ▼ When you select a new Program for a slot, a Program Change message is transmitted via MIDI, on the *slot's* MIDI Channel.
- ▼ Likewise, if a Program Change message is received on a certain MIDI Channel, all Program slots set to that MIDI Channel will switch to a new Program.
- ▼ When you select a new Performance, a Program Change message is transmitted on the *Global* MIDI Channel. For information on how to set the Global MIDI Channel, see page 60.
- ▼ When a Program Change message is received on the Global MIDI Channel, a new Performance is selected.

---

If the Global MIDI Channel happens to be set to the same number as one of the Program slots, the Performance takes precedence. That is, Program Change messages on this MIDI Channel will select Performances, not Programs.

---

## Bank Select

---

Bank Select messages are only received, not transmitted.

---

If you use a PCMCIA card, received Bank Select messages can be used to switch between the internal Bank and the three Banks on the card on the slot's MIDI Channel, just as with Program Change, see above. The lowest Bank Select number selects the internal Bank, the second selects the first PCMCIA Bank and so on.

---

Bank Select must always be used in combination with Program Change, or no Bank change will take place.

---

## System Exclusive

Program settings can be transmitted as a System Exclusive “bulk dump”. See page 71.

# USING NORD LEAD WITH A SEQUENCER

## Connections

1. Connect MIDI Out on the Nord Lead to a MIDI In on your sequencer.
2. Connect a MIDI Out from your sequencer to a MIDI In on the Nord Lead.

## Local On/Off

If your sequencer “echoes” all received MIDI signals via its MIDI Output(s) (which it probably does, look for a function called “MIDI Thru”, MIDI Echo”, MIDI Merge”, “Soft Thru” or similar), the Nord Lead should be set to Local Off. See page 58.

## MIDI Channels

- ▼ Which MIDI Channel the Nord Lead *transmits* on depends on which of the four Program slots is active (see page 13).
- ▼ All four Program Slots always *receive* MIDI, regardless of which one is selected, or if layering of one or more slots is activated or not. However, all Slots used in a Layer (i.e. all Slots that are activated) will *also* receive on the MIDI channel set for the leftmost active Slot!  
This means that if you have a layer consisting of Slots A, B and D, and Slot A is set to MIDI channel 1, both Slots B and D will receive on channel 1, as well as on their respective set channels.

---

Therefore, if you want the sequencer to control the four Program Slots independently (i.e. not in a layer), make sure only one of the Slots is active on the Nord Lead (only one Program Slot LED is lit)

---

1. **Set up the Program slots that you plan to use so that they transmit/receive on the desired MIDI Channels.**  
To set a slot's MIDI Channel, hold down Shift, and press MIDI Ch. Then select the Program slot, and set the value. See page 59 for details.
2. **Set the program slots that you *don't* plan to use, to MIDI Channel “Off”.**  
This is to ensure they don't play any sound unintentionally.
3. **Select the desired Program for each Program slot.**

4. If your sequencer requires you to transmit on a certain MIDI Channel (the same MIDI Channel as the slot receives on), select the desired slot, before recording.
5. If needed, set the sequencer up to record and play back on the desired MIDI Channel.
6. Activate recording and play the Nord Lead.
7. For an overdub with a new sound, either select the next Program slot, or just select a new Track and a new MIDI Channel in the sequencer.  
Which of the two alternatives that is right for you depends on your sequencer, not the Nord Lead.

### Program Change

For the Nord Lead to transmit and receive Program Change messages, Program Change must be activated, see page 59.

- ▼ To record a Program Change for a certain Program slot, activate recording in the sequencer and simply select a new Program for the slot.
- ▼ To record a change of Performance, go into Performance mode, activate recording in the sequencer and select the Performance from the front panel.

---

When playing back the Performance Program Change message from the sequencer, make sure it gets transmitted on the Nord Lead's *Global* MIDI Channel (see page 60).

---

### Controllers

For the Nord Lead to transmit and receive Control change messages from the front panel this must be activated, see page 59. Modulation wheel and pedal, however, are always transmitted/received.

- ▼ When you record front panel movements, make sure you have the right Program slot activated, and that the sequencer “echoes” the changes back on the right MIDI Channel, or your changes will affect the wrong sound!
- ▼ If two (or more) Program slots are set up to receive on the same MIDI Channel, both will be affected by the changes!
- ▼ Please read the note about Controller transmission in Local Off mode on page 58.

### Some notes about Controllers and “Chasing”

Consider a situation in which you record a Controller message, e.g. a filter opening, in the middle of your sequencer song. Then you “rewind” the sequencer, to a position before the recorded filter opening. The problem is, that the Nord Lead's filter will remain opened, although it really should be as it was before you recorded the filter opening. To solve such problems, several sequencers include a function called “chasing”, which keeps track of Controller changes and tries to adjust the settings on the instrument according to the current position in the sequencer song.

However, in our case, this wouldn't help much, because the filter opening was the *first* Controller message recorded in the song. The sequencer has no information about the filter setting before the recorded change, and therefore cannot “chase” the settings properly. To solve this, you could record a “snapshot” of all Controller settings on the Nord Lead panel, at the beginning of your sequencer song. This is best done by sending an “All Controllers Request” Sys Ex message from the sequencer to the Nord Lead, which will respond by dumping all its Controller values into the sequencer for recording. The “All Controllers Request” message is described on page 95.



## BULK DUMP

To dump one or more Programs or Performances via MIDI as System Exclusive data, for reprogramming of another Nord Lead or for recording the data into another MIDI device, proceed as follows:

1. Connect a cable from MIDI Out on the Nord Lead to MIDI In on the other device.
2. Set up the receiving device so that it accepts System Exclusive data.
3. To Dump *Performances*, enter “Performance Mode” (see page 33). To Dump *Programs* or *Percussion Kits*, make sure you are not in Performance mode.
4. If you want to transmit one Program/Performance only, select it.
5. If needed, set the other device to its “recording mode”.
6. Hold down the Shift button and press “Dump One” (Oct Shift +) to transmit the current Program/Performance only or “Dump All” (Oct Shift –) to transmit all Programs/Performances.

To receive a Bulk Dump, proceed as follows:

1. Connect a cable from MIDI Out on the transmitting device to MIDI In on the Nord Lead.
2. If you are about to receive a complete Bank, you need to scroll to a program number in the Bank (single Sound Bank or Performance Bank) you want to replace with the received Bank.
3. Initiate the transmission on the transmitting device.

If the dump contained a complete Bank, it will take the place of the selected Bank in the Nord Lead. If the dump contained one Program/Performance only, this will be put in the “edit buffer” of the active slot, instead of the Program/Performance you were playing. However, it is not saved permanently. To save it, use Store as described on page 23 and page 35.

---

Remember that any Percussion Kits in a Performance, will only be included as “references” when you dump the Performance. If you want to dump Percussion Kits including all parameters, you have to be in Program mode!

---



# 1 1 . ABOUT SUBTRACTIVE SYNTHESIS

## INTRODUCTION

Subtractive synthesis is one of the oldest and most widely spread forms of synthesizing sounds. It is the method employed in such classics as the Moog synthesizers, the Sequential Prophet-5 and 10, Arp synthesizers, most Oberheim synthesizers, the Roland Jupiter models, the TB-303 etc; the list is practically endless. Even new digital instruments such as workstations and sample playback devices employ many of the basic principles of subtractive synthesis.

So what's the big deal about the Nord Lead then? Simply another "subtractive synthesizer"? Well, the Nord Lead is the first modern, digital instrument that combines a faithful reproduction of the behaviour of the old analog favourites with the convenience and stability of the newer designs.

The purpose of this chapter is to give you a quick introduction to this world of subtractive synthesis as used in the Nord Lead and its analog predecessors. If you'd like to know more, there are number of text books on the subject.

## THE BUILDING BLOCKS

Subtractive synthesis started its life in *modular synthesizers*, large cabinets housing separate electronic modules, connected via patch cords. With the advancement of technology, the functionality of many of these modules could be put onto one single circuit board. But functionality-wise, subtractive synthesizers are still built out of the same modules (or building blocks) as they were decades ago.

We will now take a closer look at these building blocks. Let's first talk about the three that actually create and process sound:

### **Oscillator**

The Oscillator is actually the only thing in a synthesizer that actually *produces* any sound, (all the other modules only *shape* the sound from the oscillator.) The oscillator is a bit like the string on a string instrument, it vibrates to create sound.

### **Filter**

The signal from the oscillator is sent through the Filter which shapes the *timbre* of the sound to make it "bright", "dull", "thin", etc.

### **Amplifier**

The Amplifier shapes the *volume* of the sound making it "soft" or "hard", "slow" or "short".

In addition to these major three modules all synthesizers also have "modulators", devices that can make the volume, timbre pitch and other qualities of sound vary continuously when you play a key. It is these modulators that basically add animation to the sound, taking it from a dull organ drone to a dynamic and interesting timbre. The two most common modulators are Envelopes and LFOs:

## Envelopes

An envelope is used to give a sound a “shape”. If you apply an envelope to the amplifier (which controls the volume) you are able to make the sound for example slowly fade in and then fade out when you press and hold a key.

## LFOs

LFO is an abbreviation for Low Frequency Oscillator. It is used for repeating variations in a sound, such as vibrato or tremolo.

## CONNECTIONS

There are many ways in which the modules outlined above can be connected in a synthesizer, but the one in the picture below is a basic and common one, used in the Nord Lead (although the illustration depicts far from all the possibilities in this instrument!)

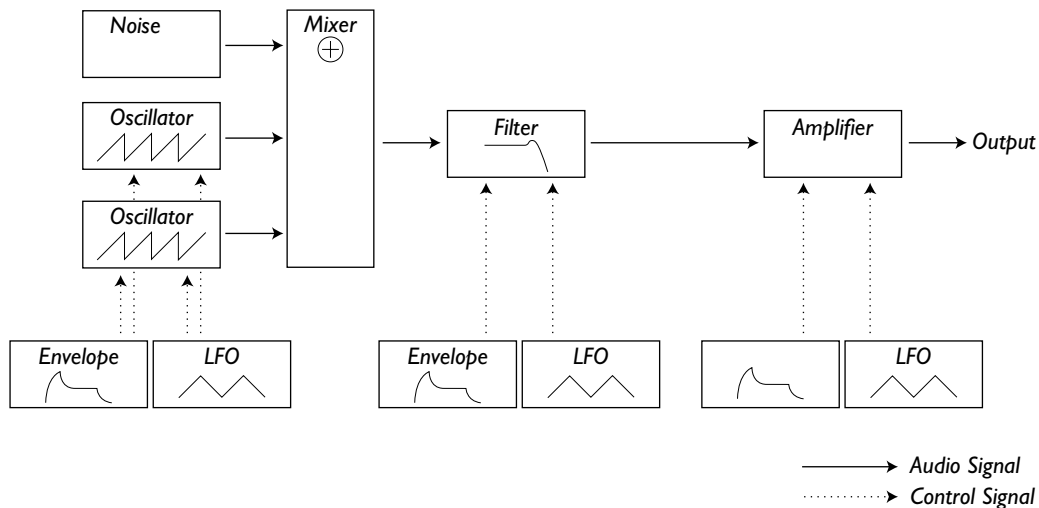

Note that the horizontal lines indicate the way the sound travels. The vertical lines indicate control signals. The envelopes for example only *modulate* (control) the oscillator, filter and amplifiers, they do not affect the sound directly.

## THE OSCILLATORS AND WAVEFORMS

The two basic qualities of an oscillator is waveform and pitch.

### Pitch

The picture of the sawtooth on the Nord Lead front panel displays a sawtooth during one *period* of sound. During this time, the wave raises gradually up to maximum level and then instantly drops back to minimum level.

The length of the period determines the pitch (frequency) of the sound. The shorter the period, the higher the pitch. If you for example make the oscillator play at a frequency of 440Hz, there will be 440 periods of identical Sawtooth waves generated per second.

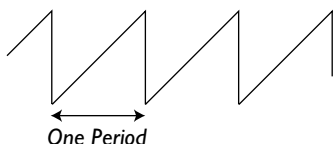

Normally there are three ways to change the frequency of an oscillator:

- ▼ By making settings on the front panel.  
On the Nord Lead for example, you have an “Oct Shift” setting for both oscillators and separate Semitone and Fine Tune adjustments for Oscillator 2.
- ▼ By playing the keyboard.  
The keyboard is of course connected to the oscillator so that pressing different key produces different pitches. In some cases this connection can be turned off, so that the oscillator always plays the same pitch, regardless of which key is pressed. In the Nord Lead, this can be done for Oscillator 2, by deactivating “Kbd Track”.
- ▼ By Modulation  
Modulation allows you to make the pitch vary “automatically”. The most common example is probably to use an LFO to make pitch go up and down, to create a vibrato. But you can also put the pitch under envelope control, or make the pitch vary with your striking force (velocity).

## Waveform

The waveform of the oscillator affects its harmonic content and thereby its “sound quality” (timbre). The three most common waveforms are sawtooth, pulse wave and triangle.

Looking at the shape of a waveform tells very little about how it sounds. Instead, there’s a better way to draw it, called a *spectrum*. Let’s introduce some quick theory:

Mathematically, all waveforms can be considered as built from a number of *harmonics*, added together.

Each of the harmonics consists of a *sine wave*, the purest and simple waveform there is (a sine wave has no harmonics at all). In other words, if you add a number of sine waves together, each one with its own pitch (frequency) and volume (amplitude), then you can build any waveform you like.

The lowest harmonic is called the *fundamental*. The fundamental determines the basic pitch of the sound. If the fundamental has a frequency of 440Hz, we will perceive the entire sound as having a pitch of 440Hz.

Other harmonics are then added to the fundamental, called *overtone*s. Normally the first overtone appears at a frequency twice the fundamental (in our example 880 Hz). The next harmonic appears at a frequency three times the fundamental (in our example 1320Hz) and so on.

In a spectral display of a waveform you can see the *frequency* (pitch) of each harmonic and its *amplitude* (level). This is done by drawing each harmonic as a line raising up from a horizontal scale.

Each line’s position on this scale indicates the harmonic’s frequency. The line furthest to the left is the fundamental, the next is the first harmonic etc. To make life easier, one usually doesn’t label the horizontal scale with frequency in Hz, but rather with the number of the harmonic.

The height of each line represents the amplitude of each harmonic.

If you understand the principle, you also understand that if the harmonics with high numbers have a high amplitude, the sound will be perceived as bright.

Let's take a look at some common waveforms and their spectra.

---

In the illustrations below, only some of the first harmonics are displayed. In reality, waveforms like these have an infinite amount of harmonics.

---

### Sawtooth

The Sawtooth wave has a simple spectrum. All harmonics are present in the wave, in proportional values. As you can see, the high harmonics have a fairly high amplitude, which makes this waveform sound bright.

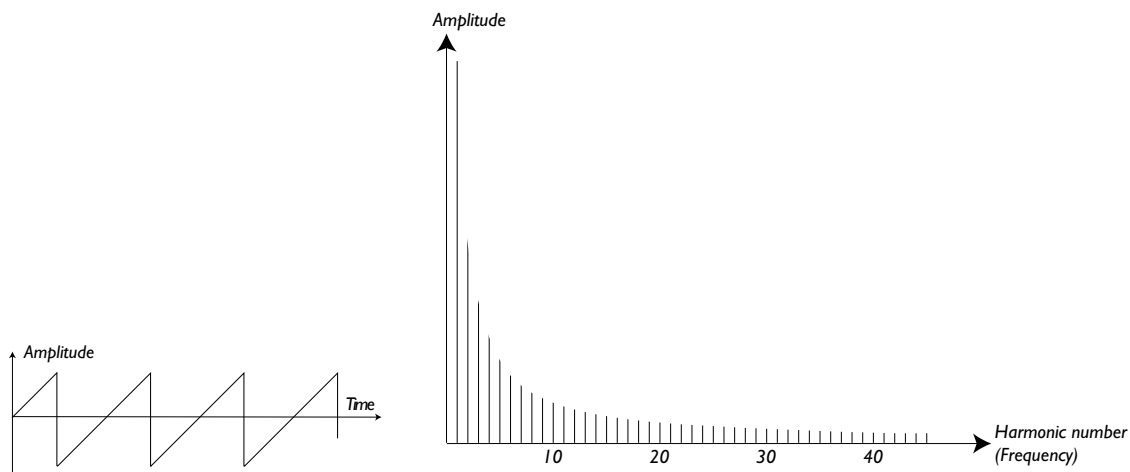

### Triangle

The triangle wave does not have very strong harmonics. Furthermore they only appear at odd harmonic numbers. The first fact makes the tone pure, a bit like a flute, and the second fact gives the sound a slightly "hollow" character.

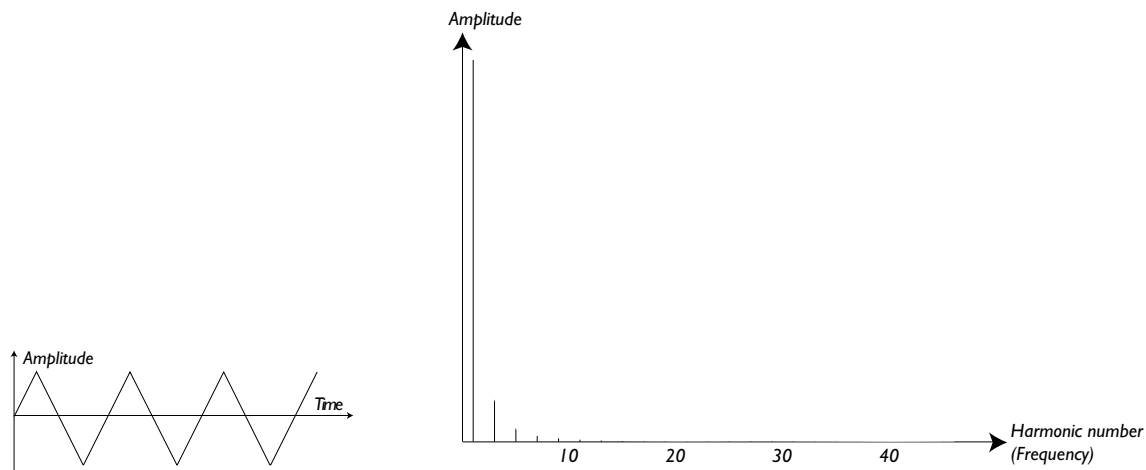

## Pulse Wave

The pulse wave is slightly more complicated, because it is not *one* waveform, it is many different ones. A pulse wave is a waveform that during one period jumps once between full positive amplitude and full negative and then back. The thing that can be varied is *where* within the period you jump from maximum to minimum amplitude. Let's look at three examples:

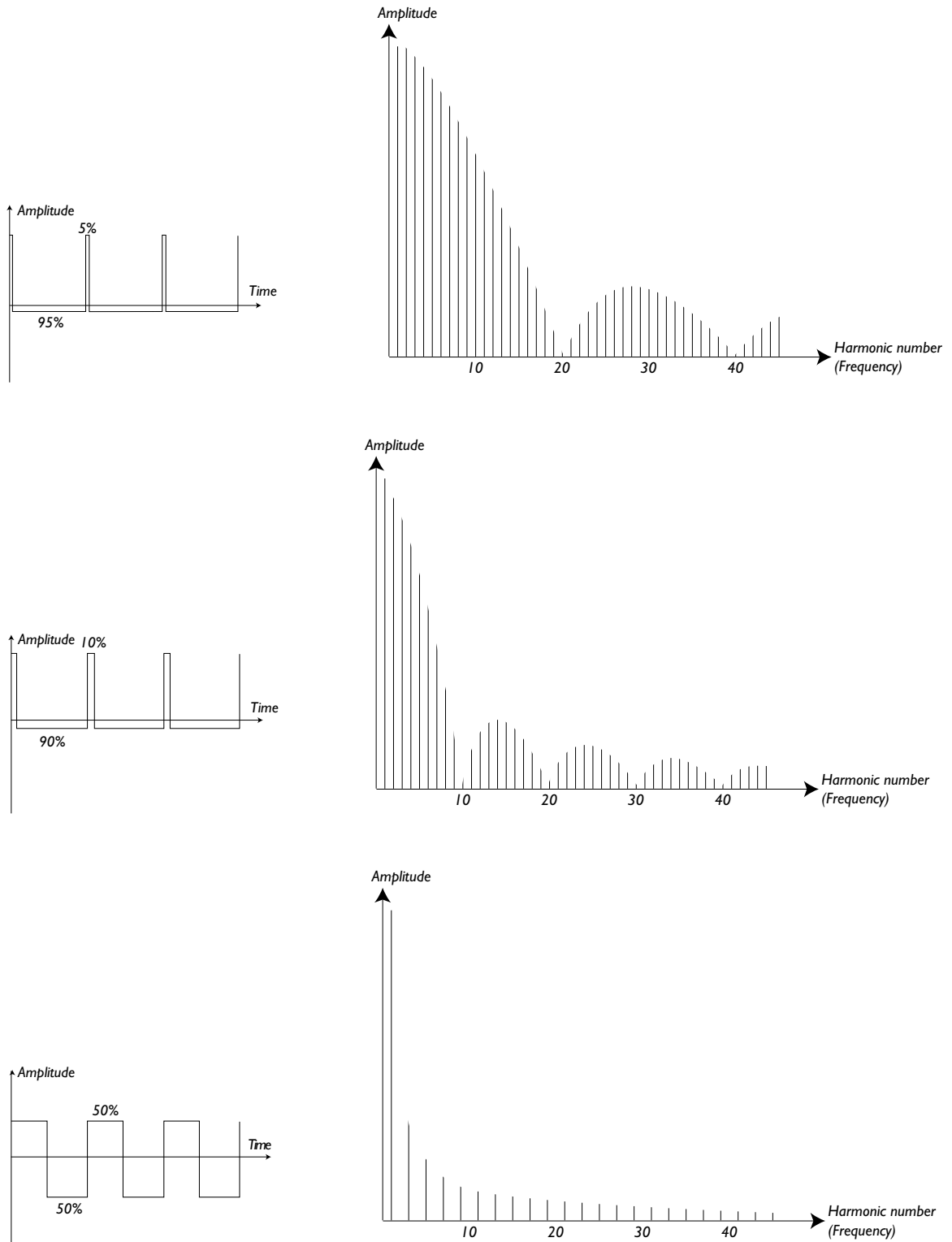

In the first, the jump happens 5% in from the beginning of the period. This is referred to as a pulse wave with a 5% *pulse width* (sometimes called *duty cycle*). The second wave has a pulse width of 10%. The third wave has a pulse width of 50%.

This third wave is a special case of the pulse wave, called a *square wave*, and this has one peculiarity, it only contains odd number harmonics, which gives it a “hollow” quality.

On many synthesizers (including the Nord Lead) the pulse width can be adjusted, to set the timbre of the pulse wave. The more narrow the pulse width, the more “thin” the sound will be.

You can also have the pulse width vary continuously, for example from an LFO or envelope. This is referred to as *pulse width modulation*. Modulating pulse widths from an LFO creates a rich, chorus-like effect often used in “string” sounds.

### About Inharmonic Spectra

Above we have only discussed spectra where the overtones appear at perfect harmonics. While this is true for the basic waveforms discussed above, it is definitely not true for all sound. If you for example use the frequency modulation (FM) capabilities in the Nord Lead, with the two oscillators set to an unusual” interval (not octaves or fifths, for example), you will get a spectrum where the overtones appear at frequencies somewhere *between* the perfect harmonics. This results in an *inharmonic* sound, which often sounds “metallic”.

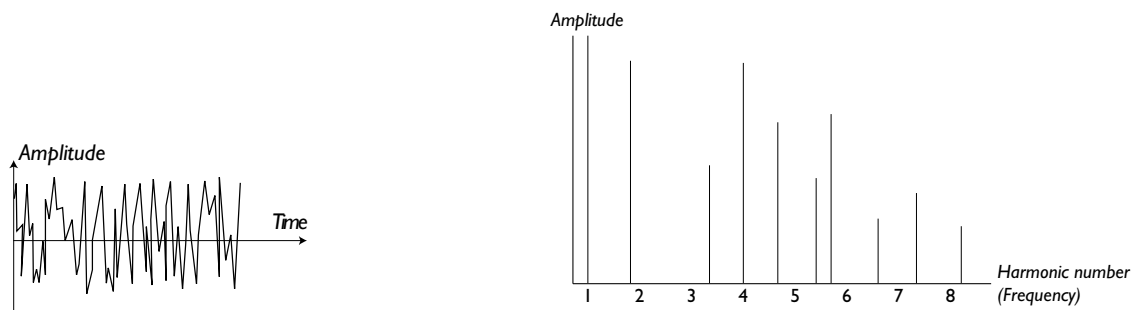

### Sync

On some instruments (including the Nord Lead), two Oscillators can be *synchronized*. If you for example synchronize Oscillator 2 to Oscillator 1, Oscillator 2 will start over with a new period of the waveform, each time Oscillator 1 does so. If Oscillator 2 then has a higher frequency than 1, it will get a complex waveform that depends both on its own pitch and on that of the other oscillator.

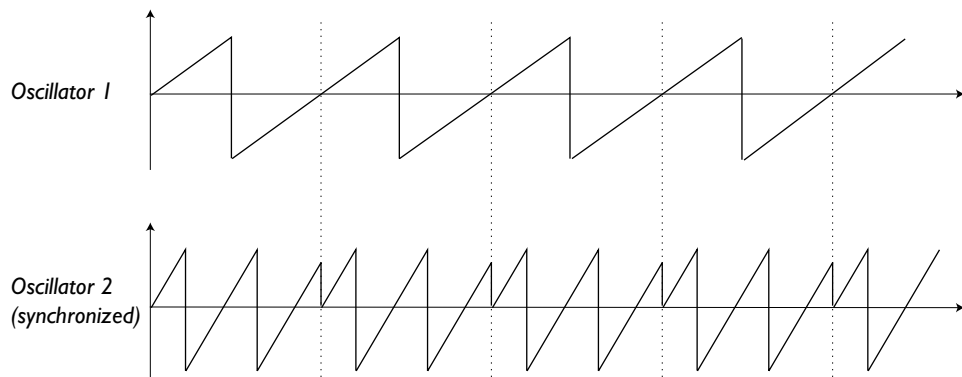



When sync is applied, the basic pitch of Oscillator 2 is locked to that of Oscillator 1. If you change the pitch of Oscillator 1 you will affect the basic pitch of both oscillators. Furthermore, when you vary the pitch of the synchronized oscillator (Oscillator 2), this will be perceived as a change in timbre, rather than in pitch.

This leads to a spectrum with deep resonances at Osc2's harmonics, like this:

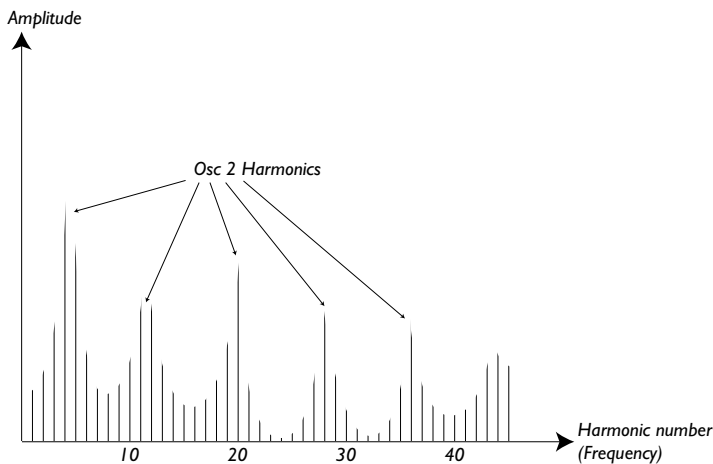

If you go even further and let the pitch of the synchronized oscillator vary continuously, for example from an LFO or envelope, you will change the harmonic content of the sound in an interesting and very characteristic way.

## THE FILTER

The filter in a synthesizer is used to remove or emphasize frequencies in a spectrum. A filter is a bit like an amplifier (a volume control) that is applied differently to different parts of the spectrum. For example, a filter might make low frequencies louder, while at the same time making high frequencies weaker. Applying such a filter would make a sound have more bass and less treble.

Let's imagine a sound with a spectrum where all harmonics are available at full level. It would look like this:

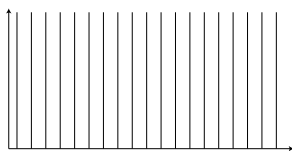

Let's now pass this spectrum through a *lowpass* filter (this type of filter is discussed in more detail below). The filter has a characteristic, which can be drawn as a curve.

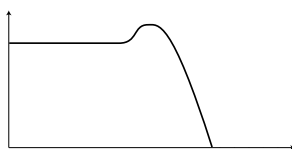

As you can see the curve is flat in the low register (which means it doesn't affect this part of the spectrum at all) and then, at a certain point, gradually starts falling. When applied to the wave above, this filter cuts away some of the high frequency material in the wave, like this:

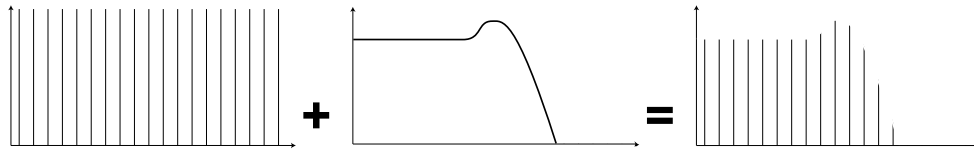

## Filter Types

There are many types of filters, all with their different purposes. We will here discuss the three most common, the ones found in the Nord Lead.

**Lowpass filter:** The Lowpass filter dampens high frequencies and let's low frequencies pass through unaffected, as in the example above. It is the most common synthesizer filter, since it can be used to "round off" the sharp sound of sawtooth waves and pulse waves.

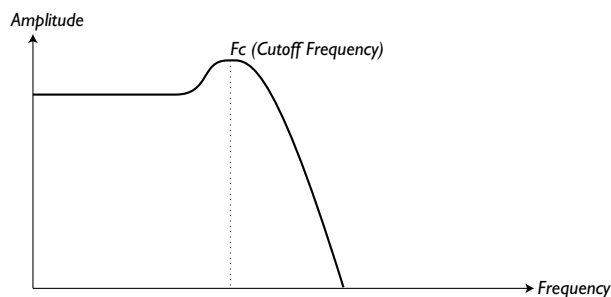

**Highpass Filter:** This is the opposite of the lowpass filter. It let's the high frequencies of the sound pass through and cuts off the low frequencies. This removes "bass" from a sound, without affecting the high end.

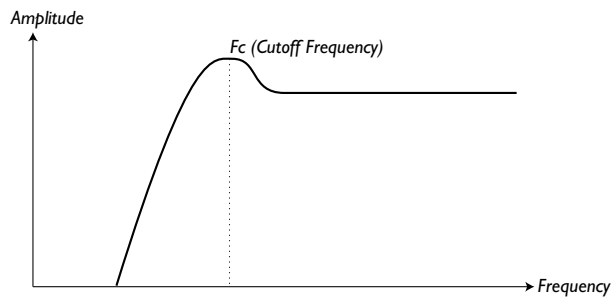

**Bandpass filter:** This lets frequencies in a certain range of the spectrum (the band) pass through while dampening frequencies both below and above this range. This accentuates the mid-range of a sound.

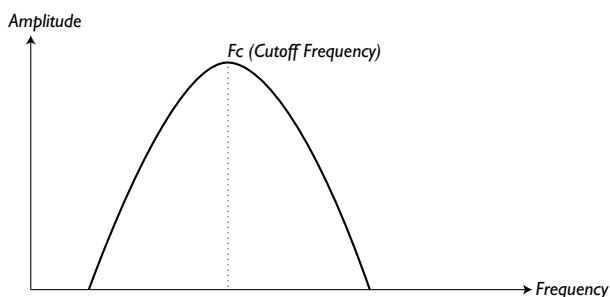

**Notch filter:** This filter type (also known as Band Reject) can be seen as the opposite of a band pass filter. It cuts off frequencies in a “mid-range” band, letting the frequencies below and above through.

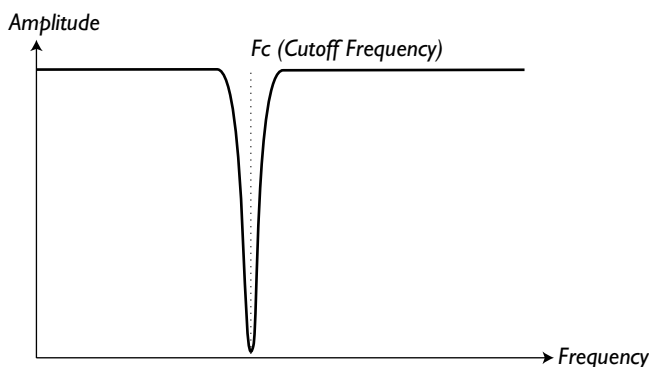

In the Nord Lead the Notch filter is combined with a 12 dB Lowpass filter, for greater musical versatility (see page 44).

### Roll-off

Filters of one and the same type (lowpass, highpass etc) can have different characteristics. One of the factors determining the exact filter curve is the *roll-off*, which is measured in *dB/Octave* (“decibels per octave”) or *poles*. The simplest possible filter has a roll-off of 6dB/octave, which is referred to as “1 pole”. The next step up is 12dB (2 poles), 18dB (3 poles) etc.

The most common synth filters are the 12dB and 24dB lowpass filters. The difference between the two can be studied in the graph below. The 12dB filter lets more of the high frequency pass through which gives the sound a brighter and “buzzier” character than the 24dB filter does.

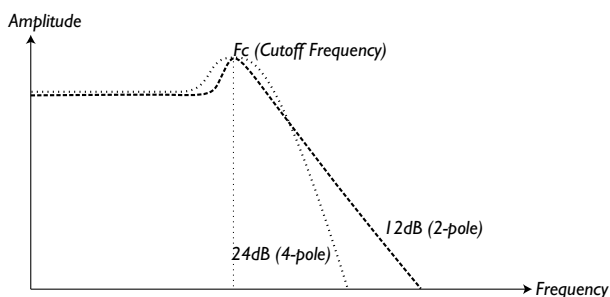

In the Nord Lead, the lowpass filter can be switched between 12 and 24dB modes. For sounds with high resonance (see below), similar to those in the Roland TB-303, we recommend the 12dB variation. For most other sounds we recommend 24dB.

## Cutoff Frequency

The most important parameter for a filter is its *cutoff frequency*, which is the setting that determines *where* in the frequency material it should start cutting. If the cutoff frequency in a low pass filter is set to a very low value, only the lowest harmonics (the bass) will pass through. If you raise the cutoff all the way up, *all* frequencies will be let through, as the figure below illustrates.

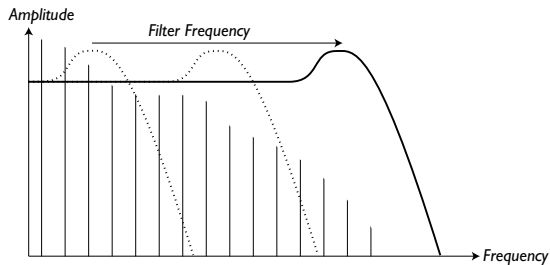

Changing the cutoff frequency is often referred to as “sweeping the filter”. This is probably one of the most important ways of shaping the timbre of a synthesizer sound. By using an envelope you can for example have a high cutoff at the beginning of a sound which is then gradually lowered (the filter “closes” as the sound decays). This would emulate the way most plucked string sound (piano, guitar etc) behave; the amplitude of the harmonics decreases as the sound decays.

## Key Tracking

When you play different pitches, the oscillators produce different frequencies. This means that the overtones in the waveform appear at different frequencies. The cutoff frequency of the *filter* however, is fixed. This means that different overtones will be cut off at different pitches. To be more precise, the further up the keyboard you play, the muddier the sound will be.

To remedy this problem many synthesizers have a parameter called *Filter Keyboard Tracking*. When this is activated, the filter Cutoff Frequency varies with which key you play, just as the oscillator frequency does. This ensures a constant harmonic spectrum for all keys.

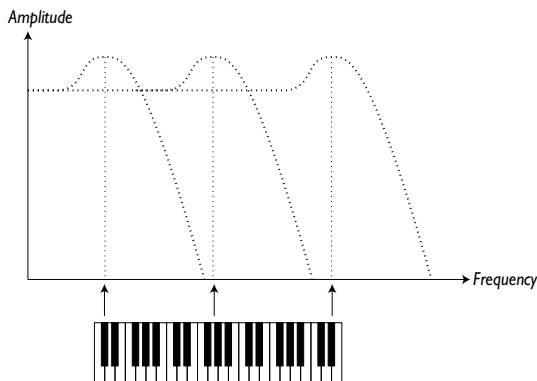

## Resonance

Resonance in a filter is created by connecting the output of the filter to its input, in other words setting up a “feedback loop”. The amount of feedback is then controlled with a Resonance parameter on the front panel of the instrument.

When you apply resonance, the frequencies just around the cutoff point of the filter will be emphasized (louder). As you increase the Resonance further and further, the filter will start to behave more and more like a bandpass filter, where only the frequencies around the cutoff point are let through. The filter will start to “ring”, which means it almost sounds like it is *adding* frequencies to the sound. If the Resonance is then raised even further (on some synthesizers) the filter will start to self-oscillate, that is produce sound of its own, just like an oscillator.

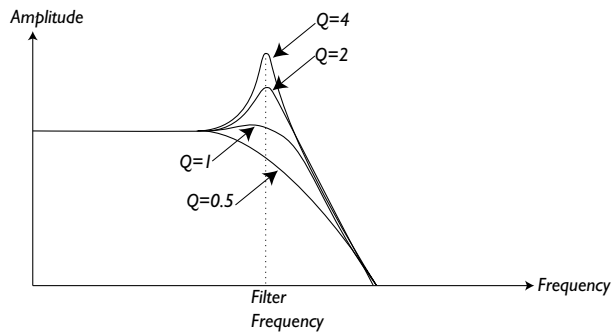

High Resonance values are also visible in the waveform. They appear as a “superimposed” waveform with a frequency equivalent to the filter’s cutoff frequency. The three examples above show the same wave with increased resonance.

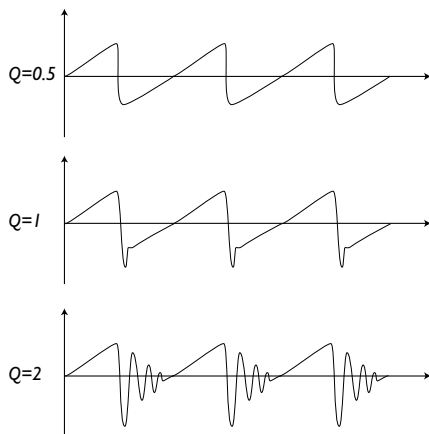

If you add Resonance to a sound and then vary the Cutoff frequency (for example with an envelope) you will get a very typical synthesizer sound.

## THE AMPLIFIER

An amplifier is most often used at the final stage of a synth signal chain, to control volume. By modulating the amplifier with an envelope, the sound can be given its basic “shape”. In fact, the “volume shape” is one of the most important factors to how we identify the sound. By setting up a proper volume envelope you can make a sound “soft”, “hard”, “plucked” “static” etc.

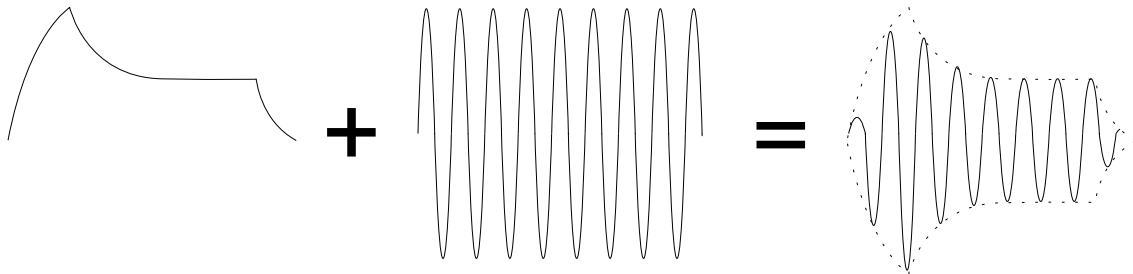

The volume envelope curve (to the left) determines how the amplitude of the waveform changes over time.

## ENVELOPES

### ADSR-Envelope

Envelopes are used to modulate pitch, amplitude, filter cutoff and other parameters in a sound. This is used to give the sound a varying character from the moment the key is pressed to the moment it is released.

The classic synthesizer envelope has four parameters, Attack, Decay, Sustain and Release, and is therefore often referred to as an “ADSR-envelope”.

When you press a key, the envelope is *triggered*. This means it starts rising from zero to maximum level. How long this should take, depends on the *Attack* setting. If the Attack time is set to “0”, the envelope will instantly reach full level. If it is raised it will take longer.

If you for example have an envelope controlling volume, raising the attack will give the sound a “softer” character. If you have the envelope routed to the filter, it might give the sound a “wah” type of start.

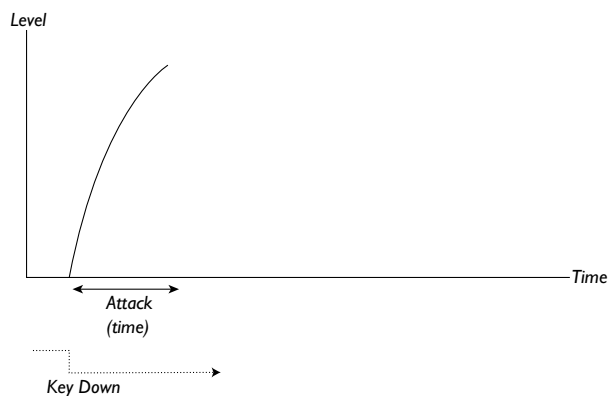

After the envelope has reached full level, it starts to fall back again. How long this should take, is set with the *Decay* parameter.

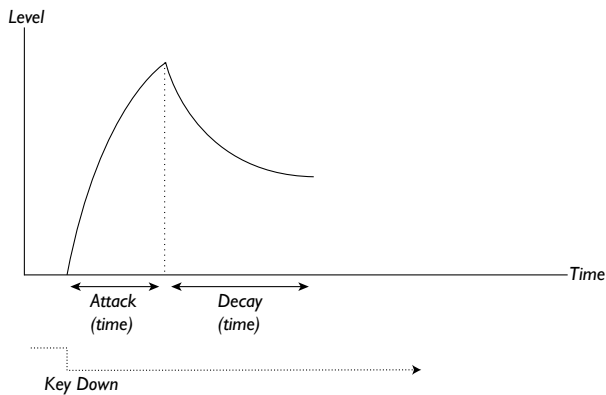

The level of the envelope does not necessarily have to fall all the way back to zero level at the end of the Decay. Instead, the ADSR-envelope has a *Sustain* setting used to determine the level the envelope should rest at, after the Decay. If you for example want to create a flute sound, you would have a fairly high Sustain setting on your Volume envelope, since a flute tone basically stays at a steady level for as long as you play it. On the other hand, for a piano sound, you would want a Sustain level of "0", since a piano sound decays to silence if you hold the key long enough.

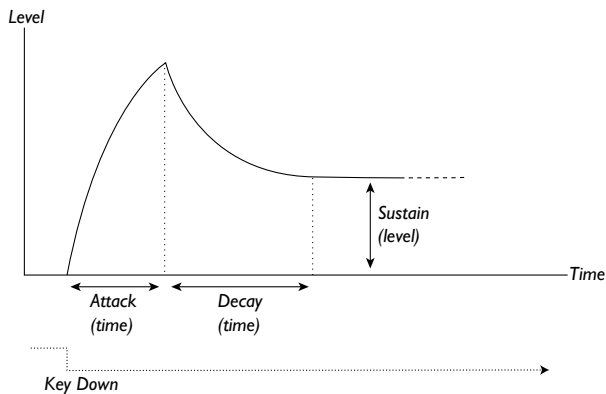

---

Please note that the Sustain parameter represents a *level*, but all other envelope parameters represent *times*.

---

As described above, the envelope stays at the Sustain level until the key is released. It then falls back to zero level. The time it should take for this to happen is set with the *Release* parameter, which works just as the Decay, only it is not applied until you lift your finger off the keys.

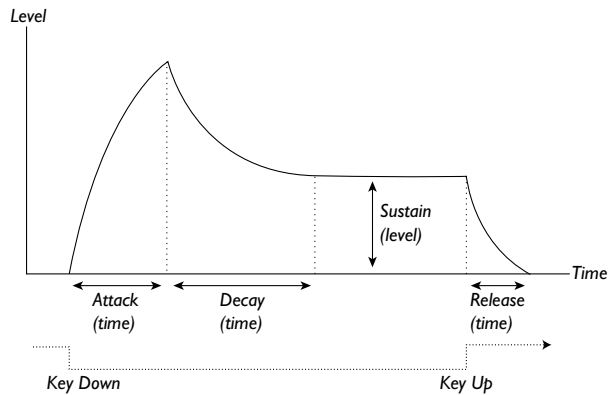

- ▼ If you set Sustain to full level, the Decay setting is of no importance since the volume of the sound is never lowered.

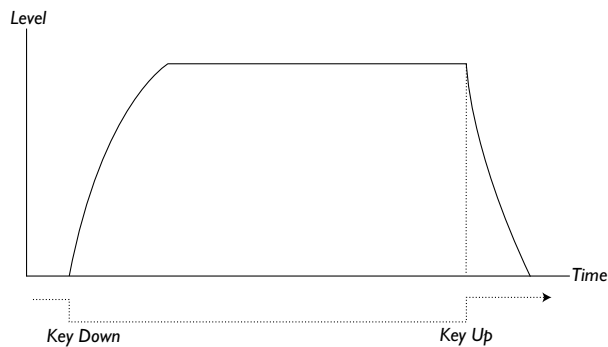

- ▼ If you set Sustain to 0, the sound will become silent after the Decay phase is finished. With short Attacks moderate Decay times, this can be used to simulate the behaviour of a plucked string instrument (guitar, piano etc) where the sound always decays to silence after a while.

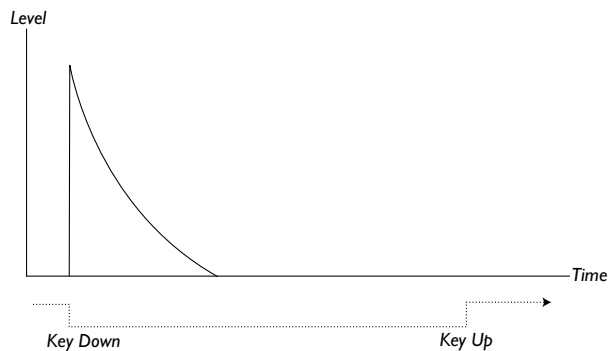



- ▼ If you release a key before the envelope has reach its sustain, it will immediately “jump” to the Release. The effect of this can be studied in the illustration below.

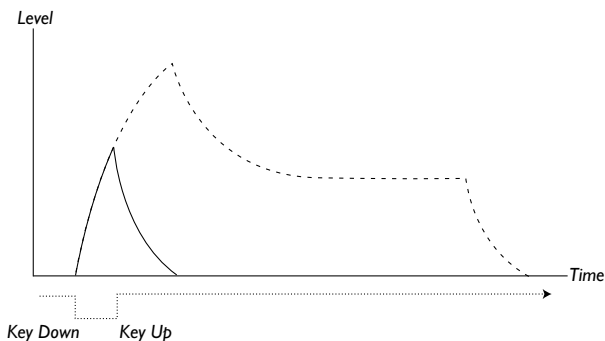

- ▼ Often envelope levels can be made to vary with how hard you play the keys. This is used to make a sound vary with your playing style, for example to make the sound brighter (filter envelope) or louder (amplifier envelope).

### AD-Envelope

A simpler form of envelope has Attack and Decay parameters only, and is therefore called an AD-envelope. In effect, the AD-envelope behaves like an ADSR-envelope with Sustain set to 0 (see the picture at the top of this page??). This type of envelope, often with amount and inversion controls, is suitable when you want to affect the start of the sound only.

On the Nord Lead, the Modulation Envelope is of AD-type. Typically, it can be made to modulate the FM amplitude or the pitch of Oscillator 2, to create a different timbre during the attack part of the sounds.

## LFOs

An LFO is an oscillator, just like the ones that produce the sound in a synthesizer, but with two main differences:

- ▼ The LFO produces very low frequencies, most often below the hearing range (up to 20Hz).
- ▼ The LFO is not used to produce sound, instead it is connected to other modules to provide modulation of parameters.  
If you for example route an LFO to pitch, you get a vibrato. If you route it to the filter's cutoff frequency you get a wah-wah type of effect. And if you route it to the amplifier of an instrument you get a tremolo.

The three basic parameters for an LFO are *Waveform*, *Rate* (frequency) and *Amount*:

- ▼ The waveform determines the type of vibrato, for example “regular” (triangle or sine), ramp (sawtooth) or random.
- ▼ The Rate determines the speed of the vibrato.
- ▼ The Amount controls to what degree the LFO affects its destination.



# 12. MIDI IMPLEMENTATION

## CONTROLLER NUMBER LIST

The following is a list of the MIDI Controller numbers used for all knobs and buttons on the front panel. See page 70.

- ▼ The reception and transmission of Controllers can be turned on/off. See page 59.
- ▼ Buttons that control “on/off” functions have a Controller value of “0” corresponding to the “off” position and a value of “1” corresponding to the “on” position.
- ▼ Buttons that step through various possibilities start with a Controller value of “0” for the “lowest” setting and then increment with a value of 1 for each step upwards.

---

If you want to send Controllers to Percussion Kits, proceed with caution! The Controller message you send will affect the percussion sound that was last selected for editing, by pressing a black key on the keyboard (see page 30).

---

<b>Nord Lead Parameter</b>	<b>MIDI Controller #</b>	<b>MIDI Controller Name</b>
Gain	7	Main Volume
Oct Shift	17	General Purpose #2
Mod Wheel Destination	18	General Purpose #3
Unison	16	General Purpose #1
Poly/Legato/Mono	15	Undefined
Portamento Auto	65	Portamento On/Off
Portamento Time	5	Portamento Time
LFO 1 Rate	19	General Purpose #4
LFO 1 Waveform	20	Undefined
LFO 1 Destination	21	Undefined
LFO 1 Amount	22	Undefined
LFO 2/Arpeggio Rate	23	Undefined
LFO 2 Destination/Arpeggio Mode	24	Undefined
LFO 2 Amount/Arpeggio Range	25	Undefined
Modulation Envelope Attack	26	Undefined
Modulation Envelope Decay	27	Undefined
Modulation Envelope Destination	28	Undefined

<b>Nord Lead Parameter</b>	<b>MIDI Controller #</b>	<b>MIDI Controller Name</b>
Modulation Envelope Amount	29	Undefined
Osc 1 Waveform	30	Undefined
Osc 2 Waveform	31	Undefined
Osc 2 Semitones	78	Sound Controller 9
Osc 2 Fine Tune	33	LSB for Controller 1
Oscillator FM Depth	70	Sound Controller 1 (Sound Variation)
Osc 2 Keyboard Tracking	34	LSB for Controller 2
Oscillator Pulse Width	79	Sound Controller 10
Oscillator Sync	35	LSB for Controller 3
Oscillator Mix	8	Balance
Amplifier Envelope Attack	73	Sound Controller 4 (Attack)
Amplifier Envelope Decay	36	LSB for Controller 4
Amplifier Envelope Sustain	37	LSB for Controller 5
Amplifier Envelope Release	72	Sound Controller 3 (Release)
Filter Envelope Attack	38	LSB for Controller 6
Filter Envelope Decay	39	LSB for Controller 7
Filter Envelope Sustain	40	LSB for Controller 8
Filter Envelope Release	41	LSB for Controller 9
Filter Mode	44	LSB for Controller 12
Filter Cutoff	74	Sound Controller 2 (Timbre)
Filter Resonance	42	LSB for Controller 10
Filter Envelope Amount	43	LSB for Controller 11
Filter Velocity	45	LSB for Controller 13
Filter Keyboard Track	46	LSB for Controller 14

In addition to the above, following controllers are used:

- ▼ The Modulation wheel transmits and receives Controller 1.
- ▼ If the Pedal input is used with an expression pedal, this is transmitted and received as Controller 11.
- ▼ If the Pedal input is used for sustain, this is transmitted as Controller 64 (Damper Pedal)
- ▼ Bank Select messages (Controller 0 and 32) are received.

## SYSTEM EXCLUSIVE IMPLEMENTATION

Numbers are in decimal except when preceded by a “\$” character, in which case they are in hexadecimal format.

### General Message format

Byte	Description
\$F0	System Exclusive
\$33	Manufacturer ID (clavia)
<Device ID>	= Global MIDI Channel, 0-15
\$04	Model ID for Nord Lead
<Message Type>	See each type of message, below.
<Message Specification>	See each type of message, below.
<Data 1>	This and following bytes depend on the Message Type and Message Specification. Some messages have no data bytes at all.
<Data 2>	
<Data 3>	
<etc.>	
\$F7	End Of Exclusive

### Patch Dumps

This message contains the actual Patch Dump. One complete message contains the data for one Patch. It is transmitted *from* the Nord Lead in one of two cases:

- ▼ When a Patch Dump is initiated from the front panel.
- ▼ When a valid Patch Dump Request message has been received.

This message should be sent *to* the Nord Lead when you want to replace a Patch currently in the instrument, with a new one.

The Message Type and Message Specification bytes in the Sys Ex message contains information about from which location the Patch Dump was sent. When a Patch is sent to the Nord Lead, it will end up in this location.

- ▼ If the Sys Ex data *for a complete Bank* is sent (using the “Dump All” command), the Program location within the Bank is stored for each Patch. When any or all of these Patches are sent back to a Nord Lead, they will be stored at their original Program Location, but in the Bank that is currently selected on the Nord Lead.
- ▼ If the Sys Ex data for a single Patch is sent *using the “Dump One” command*, it is considered being sent from the *Edit Buffer of the selected Slot*. This means, that when the Patch is sent back to a Nord Lead, it will not actually be stored, but temporarily placed in the Edit Buffer of its original Slot.

- ▼ If the Sys Ex data for a single Patch is sent *upon receiving a Patch Dump Request message*, either the Program Location or the Edit Buffer will be stored, depending on the Message Type byte in the Request message. This will also determine where the Patch will be placed when it is sent back to a Nord Lead.

Byte (Hex)	Byte (Decimal)	Description
\$F0	240	System Exclusive
\$33	51	Manufacturer ID (clavia)
<Device ID>		= Global MIDI Channel. 0 to 15 (\$0-\$F).
\$04	4	Model ID for Nord Lead
\$00 to \$04	0 to 4	Message Type specifies the Bank. 0=Edit Buffer, 1 to 4=Bank 1 to 4
\$00 to \$03 or \$00-\$62	0 to 3 or 0 to 98	Message Specification specifies the exact memory location, see below.
<Patch Data 1>		See page 96.
<Patch Data 2>		
<Patch Data 3>		
:		
<Patch Data 132>		
\$F7	247	End Of Exclusive

- ▼ If Message Type = 0 (Edit Buffer), the Message Specification can be 0 to 3, corresponding to Patch Slot buttons A to D.
- ▼ If Message Type = 1 to 4, then the Message Specification (00 to 98) corresponds to the Program Number within the Bank (01 to 99).

### **Percussion Kit Patch Dump**

This message contains all settings in a Percussion Kit. It is transmitted *from* the Nord Lead in one of two cases:

- ▼ When a Patch Dump is initiated from the front panel and a Percussion Kit is selected.
- ▼ When a valid Patch Dump Request message has been received, specifying a Percussion Kit location or an Edit Buffer containing a Percussion Kit.

Percussion Kit Patch Dump messages will also be sent if the “Dump All” command is used.

This message should be sent *to* the Nord Lead when you want to replace a Percussion Kit currently in the instrument, with a new one. When it comes to the location of the received Percussion Kit Dumps, the same rules apply as when receiving regular Program Dumps. Just remember that the internal Percussion Kit locations in the Nord Lead cannot be overwritten.

<i>Byte (Hex)</i>	<i>Byte (Decimal)</i>	<i>Description</i>
\$F0	240	System Exclusive
\$33	51	Manufacturer ID (clavia)
<Device ID>		= Global MIDI Channel. 0 to 15 (\$0-\$F).
\$04	4	Model ID for Nord Lead
\$00 to \$04	0 to 4	Message Type specifies the Bank. 0=Edit Buffer, 1 to 4=Bank 1 to 4
\$10 to \$13 or \$63-\$6C	16 to 19 or 99 to 108	Message Specification specifies the exact memory location, see below.
<Patch Data 1>		Patch data for eight percussion sounds. See page 96.
<Patch Data 2>		
<Patch Data 3>		
:		
<Patch Data 1056>		
\$F7	247	End Of Exclusive

- ▼ If Message Type = 0 (Edit Buffer), the Message Specification can be 0 to 3, corresponding to Patch Slot buttons A to D.
- ▼ If Message Type = 1 to 4, then the Message Specification (99 to 108) corresponds to the Percussion Kit locations (P0 to P9).

### **Patch Dump Request**

This message is used for requesting the Nord Lead to transmit one Patch or Percussion Kit Dump Message. The Message Type and Message Specification are used to specify which Patch should be transmitted.

This message is never transmitted *from* the Nord Lead.

<i>Byte (Hex)</i>	<i>Byte (Decimal)</i>	<i>Description</i>
\$F0	240	System Exclusive
\$33	51	Manufacturer ID (clavia)
<Device ID>		= Global MIDI Channel. 0 to 15 (\$0-\$F).
\$04	4	Model ID for Nord Lead
\$A to \$E	10 to 14	Message Type specifies the Bank. \$A=Edit Buffer, \$B to \$E=Bank 1 to 4
\$00 to \$03 or \$00-\$6C	0 to 3 or 0 to 108	Message Specification specifies the exact memory location, see below.
\$F7	247	End Of Exclusive

- ▼ If Message Type = 10 (Edit Buffer), the Message Specification can be \$00 to \$03, corresponding to Patch Slot buttons A to D.

- ▼ If Message Type = 11 to 14, then the Message Specification (00 to 98) corresponds to the Program Number within the Bank (01 to 99).

### Performance Dump

This message contains the actual Performance. One complete message contains the data for one Performance.

This message is transmitted *from* the Nord Lead in one of two cases:

- ▼ When a Performance Dump is initiated from the front panel.
- ▼ When a valid Performance Request message has been received.

This message should be sent *to* the Nord Lead when you want to replace a Performance currently in the instrument, with a new one. The Message Type and Message Specification then specify in which memory location the Performance should be stored.

<i>Byte (Hex)</i>	<i>Byte (Decimal)</i>	<i>Description</i>
\$F0	240	System Exclusive
\$33	51	Manufacturer ID (clavia)
<Device ID>		= Global MIDI Channel. 0 to 15 (\$0-\$F).
\$04	4	Model ID for Nord Lead
\$1E or \$1F	30 or 31	Message Type specifies Performance Edit Buffer (30) or PCMCIA Card Performance Bank (31)
\$00 or \$00-\$63	0 or 0 to 99	Message Specification specifies the Performance number, see below.
<Perf. Data 1>		See page 97.
<Perf. Data 2>		
<Perf. Data 3>		
:		
<Perf. Data 688>		
\$F7	247	End Of Exclusive

- ▼ If Message Type = 30 (Edit Buffer), the Message Specification should always 0.
- ▼ If Message Type = 31, the Message Specification corresponds to the Performance Number (00 to 99).



### Performance Dump Request

This message is used for requesting the Nord Lead to transmit one Performance Dump Message. The Message Type and Message Specification are used to specify which Performance should be transmitted.

This message is never transmitted *from* the Nord Lead.

Byte (Hex)	Byte (Decimal)	Description
\$F0	240	System Exclusive
\$33	51	Manufacturer ID (clavia)
<Device ID>		= Global MIDI Channel. 0 to 15 (\$0-\$F).
\$04	4	Model ID for Nord Lead
\$28 or \$29	40 to 41	Message Type specifies Performance Edit Buffer (40) or the PCMCIA card Performance Bank. (41).
\$00 or \$00-\$63	0 or 0 to 99	Message Specification specifies the Performance number, see below.
\$F7	247	End Of Exclusive

- ▼ If Message Type = 40 (Edit Buffer), the Message Specification should always 0.
- ▼ If Message Type = 41 or 42, then the Message Specification (00 to 99) corresponds to the Performance Number (A0 to L9).

### All Controllers Request

This message instructs the Nord Lead to send all current Controller values for a specified Slot (see page 70). The message is never transmitted *from* the Nord Lead.

Byte (Hex)	Byte (Decimal)	Description
\$F0	240	System Exclusive
\$33	51	Manufacturer ID (clavia)
<Device ID>		= Global MIDI Channel. 0 to 15 (\$0-\$F).
\$04	4	Model ID for Nord Lead
\$14	20	Message Type specifies All Controllers Request.
\$00-\$03	0 to 3	Message Specification specifies the Program Slot.
\$F7	247	End Of Exclusive

## Patch and Performance Data Formats

In the Patch and Performance Dump Messages, the Data Bytes contain the actual Patch/Performance settings.

- ▼ All parameters are in 8 bit format, 2s complement (=signed). Each Byte is Nybbleized and coded into two MIDI bytes, with the low Nybble transmitted first.
- ▼ A Patch contains 66 parameters, which means the data block of a Patch Dump is transmitted in 132 (66\*2) Bytes. See the “Patch Dump Format” table, below.
- ▼ A Performance consists of five blocks. The first four blocks contains the four Patches (A to D) This block is 528 MIDI Bytes (4\*66\*2). After this follows 136 (68\*2) of data for parameters local to the Performance. See the “Performance Data Format” table, on page 97.

### Patch Dump Format

Size	Offset	Name	Min	Max	Comment
1	0	osc2pitch	0	120	middle=60
1	1	osc2pitchfine	0	127	
1	2	mix	0	127	
1	3	cutoff	0	127	
1	4	resonance	0	127	
1	5	filterenvamt	0	127	
1	6	pw	0	127	
1	7	fmdepth	0	127	
1	8	filterenvattack	0	127	
1	9	filterenvdecay	0	127	
1	10	filterenvsustain	0	127	
1	11	filterenvrelease	0	127	
1	12	ampenvattack	0	127	
1	13	ampenvdecay	0	127	
1	14	ampenvsustain	0	127	
1	15	ampenvrelease	0	127	
1	16	portamento	0	127	
1	17	gain	0	127	
1	18	modenvattack	0	127	
1	19	modenvdecay	0	127	
1	20	modenvlevel	0	127	middle=64
1	21	lfo1rate	0	127	
1	22	lfo1level	0	127	
1	23	lfo2rate	0	127	
1	24	arprange	0	127	
1	25	osc2pitch_sens	-128	127	velocity/morf sens
1	26	osc2pitchfine_sens	-128	127	0=OFF
1	27	mix_sens	-128	127	
1	28	cutoff_sens	-128	127	
1	29	resonance_sens	-128	127	
1	30	filterenvamt_sens	-128	127	
1	31	pw_sens	-128	127	
1	32	fmdepth_sens	-128	127	
1	33	filterenvattack_sens	-128	127	
1	34	filterenvdecay_sens	-128	127	
1	35	filterenvsustain_sens	-128	127	
1	36	filterenvrelease_sens	-128	127	
1	37	ampenvattack_sens	-128	127	
1	38	ampenvdecay_sens	-128	127	
1	39	ampenvsustain_sens	-128	127	
1	40	ampenvrelease_sens	-128	127	

Size	Offset	Name	Min	Max	Comment
1	41	portamento_sens	-128	127	
1	42	gain_sens	-128	127	
1	43	modenvattack_sens	-128	127	
1	44	modenvdecay_sens	-128	127	
1	45	modenvlevel_sens	-128	127	
1	46	lfo1rate_sens	-128	127	
1	47	lfo1level_sens	-128	127	
1	48	lfo2rate_sens	-128	127	
1	49	arprange_sens	-128	127	
1	50	osc1waveform	0	2	
1	51	osc2waveform	0	3	3=noise
1	52	sync	0	1	
1	53	filtertype	0	4	
1	54	osc2kbdtrack	0	1	
1	55	filterkbdtrack	0	1	
1	56	lfo1wave	0	2	
1	57	lfo1dest	0	3	
1	58	voicemode	0	2	
1	59	modwheeldest	0	4	
1	60	unison	0	1	
1	61	modenvdest	0	2	
1	62	auto	0	1	
1	63	filtervel	0	1	
1	64	octshift	0	4	
1	65	lfo2dest/arpmode	0	4	

For Percussion Kit Sys Ex Dumps, the above parameters will be repeated eight times, once for each sound in the Percussion Kit.

### Performance Data Format

Size	Offset	Name	Min	Max	Comment
264	0	"performance_patch [A,B,C,D]"			see PATCH data format
4	264	"midichan [A,B,C,D]"	0	15	
4	268	"lfo1sync [A,B,C,D]"	0	7	
4	272	"lfo2sync [A,B,C,D]"	0	7	
4	276	"filterenvtrig [A,B,C,D]"	0	1	
4	280	"filterenvtrigmidichan [A,B,C,D]"	0	15	
4	284	"filterenvtrignotenr [A,B,C,D]"	23	127	23=off
4	288	"ampenvtrig [A,B,C,D]"	0	1	
4	292	"ampenvtrigmidichan [A,B,C,D]"	0	15	
4	296	"ampenvtrignotenr [A,B,C,D]"	23	127	23=off
4	300	"morftrig [A,B,C,D]"	0	1	
4	304	"morftrigmidichan [A,B,C,D]"	0	15	
4	308	"morftrignotenr [A,B,C,D]"	23	127	23=off
1	312	bendrange	0	8	
1	313	unisondetune	0	8	
1	314	outmode	0	3	
1	315	globalmidichan	0	15	not received!!!
1	316	midiprogramchange	0	1	not received!!!
1	317	midicntrl	0	1	not received!!!
1	318	mastertune	-99	99	not received!!!
1	319	pedaltype	0	2	not received!!!
1	320	localcontrol	0	1	not received!!!
1	321	Keyboard Octave Shift	0	4	not received!!!
1	322	selected_channel	0	3	
1	323	Arpeggio MIDI Out	0	1	not received!!!
4	324	"channel_activated [A,B,C,D]"	0	1	

---

4	328	"pgmselect [A,B,C,D]"	0	98
4	332	"bankselect [A,B,C,D]"	0	3
4	336	channel pressure amt. [A,B,C,D]	0	7
4	340	channel pressure dest. [A,B,C,D]	0	4
4	344	expression pedal amt. [A,B,C,D]	0	7
4	348	expression pedal dest. [A,B,C,D]	0	4

---

# 13. FACTORY SETTINGS

## FACTORY PROGRAMS

Programs 1-40 are in the RAM bank, Programs 41-99 are in ROM.

Program	Name	Program	Name	Program	Name
1	Sawbrass	34	String pad	67	Acid 2
2	Velocity strings	35	Solo pulse	68	legato bass
3	Resonance pad	36	Space pad	69	Black Hole
4	Hard string pad	37	Sample/hold	70	Sub
5	Resonance fade pad	38	Saw legato solo	71	DB
6	Portamento quints	39	Echo sound	72	Widebody
7	A fifth pad	40	Pulse solo	73	Fluff
8	Pulse pad with FM	41	Soft strings2	74	Steeldrums
9	Weather bass	42	Majesty	75	Wurz piano
10	Lead saw solo	43	Glass brass	76	My Clav
11	Soft saw lead	44	Gimme 5	77	I bow
12	Zyntar	45	Flute choir	78	Tack clav
13	Arpeggiator down	46	Brass Comp	79	Span Eyes
14	FM Metallic	47	Sync sweep	80	Floote
15	Attack bass	48	Synth strings	81	Hamplafon
16	Saw mono	49	Trumpets	82	Thumpinet
17	Osc 2 modulation	50	Duke	83	Bell bar
18	Guitar 1	51	Dirty FM	84	Flageolettes
19	Violin	52	Space clavinet	85	Rotator
20	Source bass	53	Resonant saw	86	Tuba
21	Perc Lead	54	FM lead	87	Trumpet
22	FM Clavinet	55	Talking clavinet	88	English horn
23	Soft strings	56	Saw ring	89	Metal Flute
24	S/H techno	57	Eraser	90	Voice
25	Resonance sweep	58	Take the fifth	91	FM horn
26	Phaser	59	Echo pad	92	Harpsichord
27	Brite pad	60	Yeow!	93	Electric piano 2
28	Analog grand	61	Syncher	94	Musing
29	Electric piano 1	62	Low bass	95	Chang
30	Random Arpeggio	63	water bass	96	Ravi
31	Clarinet	64	Pick bass	97	Guess!
32	Didjeridu	65	FM morph bass	98	Tubular
33	Sax	66	Acid 1	99	Waterhall

## FACTORY PERCUSSION KITS

<i>Percussion Kit P0</i>	
	<i>Percussion Sound</i>
Zone 1	Acoustic kick
Zone 2	Snare drum
Zone 3	Hi-hat
Zone 4	Low tom
Zone 5	Mid tom
Zone 6	High tom
Zone 7	Crash
Zone 8	Cowbell

<i>Percussion Kit P1</i>	
	<i>Percussion Sound</i>
Zone 1	Surdo drum
Zone 2	Latin snare
Zone 3	Low tom
Zone 4	Bongo hi
Zone 5	Bongo low
Zone 6	Triangel
Zone 7	Guiro
Zone 8	Quica

<i>Percussion Kit P2</i>	
	<i>Percussion Sound</i>
Zone 1	Bass drum
Zone 2	Mute conga
Zone 3	Conga slap
Zone 4	Conga hi slap
Zone 5	Conga hi
Zone 6	Conga
Zone 7	Cabasa
Zone 8	Quica

<i>Percussion Kit P3</i>	
	<i>Percussion Sound</i>
Zone 1	808 kick
Zone 2	808 snare
Zone 3	Clap
Zone 4	808 rim
Zone 5	808 cowbell
Zone 6	808 conga
Zone 7	Hi-hat
Zone 8	808 Claves

<i>Percussion Kit P4</i>	
	<i>Percussion Sound</i>
Zone 1	Reverb kick
Zone 2	Paper snare
Zone 3	Hi-hat
Zone 4	Low tom
Zone 5	Mid tom
Zone 6	High tom
Zone 7	Ride
Zone 8	shot

<i>Percussion Kit P5</i>	
	<i>Percussion Sound</i>
Zone 1	909 kick
Zone 2	909 snare
Zone 3	Hat
Zone 4	Bongo hi
Zone 5	Bongo low
Zone 6	Knack
Zone 7	Electro tom hi
Zone 8	Electro tom low

<i>Percussion Kit P6</i>	
	<i>Percussion Sound</i>
Zone 1	Bass drum
Zone 2	Small quica
Zone 3	Muted
Zone 4	Talking drum
Zone 5	Indian drum
Zone 6	Finger cymbal
Zone 7	Darabouka
Zone 8	Thumb piano

<i>Percussion Kit P7</i>	
	<i>Percussion Sound</i>
Zone 1	Reverb kick
Zone 2	Echo snare
Zone 3	Heavy hats
Zone 4	Sonar 1
Zone 5	Sonar 2
Zone 6	Noise
Zone 7	Sonar 3
Zone 8	Crash

<i>Percussion Kit P8</i>	
	<i>Percussion Sound</i>
Zone 1	Hi kick
Zone 2	Tone snare
Zone 3	Rim
Zone 4	Hi-hats
Zone 5	Latin tom low
Zone 6	Latin tom mid
Zone 7	Latin tom hi
Zone 8	Xylofon

<i>Percussion Kit P9</i>	
	<i>Percussion Sound</i>
Zone 1	Techno kick
Zone 2	Snappy snare
Zone 3	Hi-hat
Zone 4	Velocity plop
Zone 5	Snap
Zone 6	Trek
Zone 7	Electro guiro
Zone 8	Echo wood

## FACTORY PERFORMANCES

<i>Performance</i>	<i>Name</i>	<i>Performance</i>	<i>Name</i>
A0	Bellbrass pad	D0	Acid clock
A1	Heavy sync sweep	D1	Future pipe
A2	Big lead	D2	Stereo Pad
A3	Orchestra bell	D3	Wheel lead
A4	Pulse sweep with a twist	D4	Expressive Lead
A5	Reverb choir	D5	Techno song
A6	Majestix	D6	Brass pad
A7	Arpeggiator string pad	D7	Saw Sweep
A8	Plucking pad	D8	Brite string pad
A9	Arpeggiator heaven	D9	Space engine
B0	Sixtifeve organ	E0	Square organ
B1	Wow pad	E1	Saw pulse pad
B2	Windy	E2	Analog grand bass
B3	Water organ	E3	Raga on white keys
B4	Big Morph	E4	Soft string pad
B5	Heavy pulse lead	E5	Voice 1
B6	Westminister	E6	Voice 2
B7	Strings and bells	E7	Voice 3
B8	The Jazz duo	E8	Dist lead
B9	Ambient bell	E9	Big bell
C0	Big pulse	F0	Jungle
C1	Unison FM lead	F1	Acid song
C2	Rise and fall	F2	Bottle
C3	Greek stuff	F3	ET go home
C4	Octave sweep	F4	Acc gitar
C5	Cyber piano	F5	Power bells
C6	Pan flute	F6	Voices
C7	Metal sweep	F7	Bells
C8	Sax-o-phone	F8	The wheel morph
C9	Mouth flute	F9	Attack



<i>Performance</i>	<i>Name</i>
G0	Piano pad
G1	Harp
G2	Echo from africa
G3	Sweep pad
G4	Magic night
G5 – H7	Drawbar Organs (see below)
H8 – J9	Prophet 5 Factory Patch Recreations (see page 105)
L0 – L9	Nord Lead RAM Programs 1-40 (Backup, see page 106)

Please note that many of the Performances consist of two-, three- or four-slot layers, which will lead to reduced polyphony, especially noticeable on a 4-voice Nord Lead.

## ABOUT THE ORGAN SOUNDS

Among the Factory Performances, there are reproductions of 13 classic organ sounds. By using layers of several Slots, combined with a special “pseudo-additive” synthesis, Clavia have filtered out a minor number of “partials” from each Oscillator and combined them into different drawbar configurations, successfully emulating the sound of drawbar organs such as the classic “B3”.

### *Drawbar Organ Essentials*

To make best use of the organ emulations and their special features, some knowledge about the original instruments might be of use. Briefly, the following building blocks were combined to create the unique drawbar organ sounds:

**Tonewheels:** These are the basic sound-generating devices. In the Nord Lead, they are of course replaced by the Oscillator section.

**Drawbars:** These are click-stopped “sliders”, usually nine, each one controlling the volume of a certain partial in the organ tone. The partials are indicated in the classic pipe organ way, referring to the length of the organ pipes. Thus, the standard drawbar configuration is (from the bottom up) :

16'	5 1/3'	8'	4'	2 2/3'	2'	1 3/5'	1 1/3'	1'
-----	--------	----	----	--------	----	--------	--------	----

By using the drawbars to change the balance between the partials, the harmonic content of the organ tone can be changed .

In the Nord Lead organ sounds, the oscillators are used to generate the partials. In some cases, there is a direct “one oscillator - one drawbar” relation; other sounds use more complex waveforms to simulate up to three combined partials with one oscillator. Usually, the oscillators in each slot are paired, so that Oscillator 1 generates the lower partial(s) and Oscillator 2 the higher. Therefore, you can give the sound more bottom or edge, by changing the Oscillator balance with the Mix knob for each Slot.

**Percussion:** To add some attack to the sound, most classic organs feature Percussion - an accent-like tone with fast attack, short decay and no sustain. Usually the pitch of the Percussion tones are 4' or 2 2/3' (or both mixed), in effect replacing the corresponding drawbar partials. Some of the Nord Lead organ sounds make use of Percussion in Slot B. You can vary the balance between the two Percussion pitches with the Mix knob, and also change the Decay time of the Percussion tone to make it fit your playing style.

**Click:** Though not an intended feature on the classic organs, the short, non-pitched click noise when keys are pressed has become a popular characteristic. In the organs, the sound came from oxidation on the key switches; in the Nord Lead you can add or remove the click as desired. All of the Nord Lead organ Performances has the click sound on Slot D, although it is by default turned off for some of the sounds.

**Hum:** This disharmonic, thin sound is also an unintended artifact, generated by leakage between the tonewheels in the organs. It is included in some of the Nord Lead organ sounds, adding even further realism.

**Rotary Speaker:** A large part of the characteristic organ sound is due to the rotary speaker cabinet. Such a cabinet "moves the sound" around, either by rotating the actual speakers, or by directing the sounds with rotating baffles or horns. Usually, the rotation speed can be changed from slow (producing a full chorus-like effect) to fast (producing a very special doppler-shifted tremolo sound). Several of the organ sounds in the Nord Lead include a Rotary Speaker effect, emulated by the LFO:s and the Morph function. Change the rotor speed from slow to fast by raising the Modulation wheel.

This table shows the drawbar configurations simulated by each organ Performance. The configuration is indicated by 9 numbers, volume settings (0 - 8) for each drawbar in the simulated sound. For all Performances, you can activate Slot D to add Click to the sound.

<i>Performance</i>	<i>Name</i>	<i>Drawbar configuration</i>	<i>Extras</i>	<i>Rotary Spkr.</i>
G5	Perc 3rd w click	880 000 000	Slot B: Perc. Slot C: Hum	No
G6	NHL	808 000 022		No
G7	W. Shade of Pale	888 600 000		Yes
G8	Straight Jazz Perc	888 000 000	Slot B: Perc. Slot C: Hum	No
G9	Soul Rotor	888 222 222		Yes
H0	One high	888 000 008		Yes
H1	All Even Harmonics	808 808 008		Yes
H2	Odd Upper Harmonics	888 040 440		Yes
H3	All Out	888 888 888		Yes
H4	Cathedral Organ	864 212 468		Yes
H5	Low	876 543 211		Yes
H6	Mid	124 686 421		Yes
H7	Super Brite	112 345 678		Yes

## ABOUT THE PROPHET-5 FACTORY SOUND RECREATIONS

Over 40 of the 120 original factory sounds from the classic vintage “Prophet 5” synthesizer have been faithfully recreated and stored in the Factory Performances of the Nord Lead. You find the Prophet sounds in Performance memory locations H8 to J9.

Since each of these sounds uses one Slot only, four different Prophet sounds have been stored in each Performance. To try out the different Patches in one Performance, select slot A, B, C or D, by pressing the respective Slot button. The names of the recreated Prophet patches refer to their original location in the Prophet 5 program banks.

<i>Performance</i>	<i>Slot A</i>	<i>Slot B</i>	<i>Slot C</i>	<i>Slot D</i>
H8	Bank 1-11	Bank 1-12	Bank 1-13	Bank 1-14
H9	Bank 1-15	Bank 1-16	Bank 1-17	Bank 1-18
J0	Bank 1-21	Bank 1-22	Bank 1-23	Bank 1-24
J1	Bank 1-25	Bank 1-26	Bank 1-27	Bank 1-28
J2	Bank 1-31	Bank 1-32	Bank 1-33	Bank 1-34
J3	Bank 1-35	Bank 1-36	Bank 1-37	Bank 1-38
J4	Bank 1-41	Bank 1-42	Bank 1-43	Bank 1-44
J5	Bank 1-45	Bank 1-46	Bank 1-47	Bank 1-48
J6	Bank 2-41	Bank 1-52	Bank 1-53	Bank 1-54
J7	Bank 1-55	Bank 1-56	Bank 1-57	Bank 1-58
J8	Bank 3-12	Bank 2-36	Bank 2-37	Bank 2-52
J9	Bank 2-54			

## RESTORING THE FACTORY PROGRAMS IN RAM

Don't hesitate to replace the Factory Programs in RAM locations 01 to 40 with sounds of your own! The Factory Programs are duplicated in ROM Performances L0 to L9, as listed below. To extract one of these sounds from its Performance, and store it as a Program, follow the instructions on page 35.

<i>Performance</i>	<i>Slot A</i>	<i>Slot B</i>	<i>Slot C</i>	<i>Slot D</i>
L0	Program 01	Program 02	Program 03	Program 04
L1	Program 05	Program 06	Program 07	Program 08
L2	Program 09	Program 10	Program 11	Program 12
L3	Program 13	Program 14	Program 15	Program 16
L4	Program 17	Program 18	Program 19	Program 20
L5	Program 21	Program 22	Program 23	Program 24
L6	Program 25	Program 26	Program 27	Program 28
L7	Program 29	Program 30	Program 31	Program 32
L8	Program 33	Program 34	Program 35	Program 36
L9	Program 37	Program 38	Program 39	Program 40

# 14. MIDI IMPLEMENTATION CHART

Model: Clavia Nord Lead (Keyboard and Rack)

Date: 96 03 21  
Version 2.x

Function		Transmitted	Recognized	Remarks
Basic Channel	Default Channel	1 – 16 1 – 16	1 – 16 1 – 16	
Mode	Default Messages Altered	Mode 3 X *****	Mode 3 X	
Note Number	True Voice	0 – 127 *****	0 – 127 0 – 127	
Velocity	Note ON Note OFF	O v = 1 – 127 X	O v = 1 – 127 X	
After Touch	Key's Ch's	X X	X O	
Pitch Bender		O	O	
Control Change		O	O	See page 89
Prog Change	True #	O 0 – 109	O 0 – 109	
System Exclusive		O	O	See page 91
System Common	: Song Pos : Song Sel : Tune	X X X	X X X	
System Real Time	: Clock : Commands	X X	O X	
Aux Messages	: Local ON/OFF : All Notes Off : Active Sense : Reset	X X X X	X X X X	
Notes				

Mode 1 : OMNI ON, POLY  
Mode 3 : OMNI OFF, POLYMode 2 : OMNI ON, MONO  
Mode 4 : OMNI OFF, MONOO : Yes  
X : No



# INDEX

## A

- Afartouch *67*
- Amount
  - LFO 1 *48*
  - LFO 2 *49*
  - Mod Envelope *50*
- Amplifier
  - Envelope *40*
  - Introduction to *73*
  - Triggering Envelope via MIDI *64*
- Amplitude Envelope *40*
- Arpeggiator *48*
- Arpeggiator range *49*
- Arpeggiator type *48*
- Arpeggio to MIDI Out *59*
- Attack
  - Amplifier *41*
  - Filter *46*
  - Introduction to *84*
  - Mod Envelope *50*
- Auto (Portamento) *54*

## B

- Band Reject *44*
- Bandpass *43*
- Bank Select *69*
- BP *43*
- Bulk Dump *71*

## C

- Cards *24*
- Controllers
  - Activating transmission/reception *59*
  - Front panel list *89*
  - MIDI Transmission and reception *67*
  - Recording in Sequencer *70*
- Copying Programs *23*

## D

- Decay
  - Amplifier *41*
  - Filter *46*
  - Introduction to *85*
  - Mod Envelope *50*
- Demo Play *9*
- Destination
  - LFO 1 *47*
  - LFO 2 *48*
  - Mod Envelope *50*
- Drum Kits
  - Copying Sounds To and From *31*
  - Editing *30*
  - Playing *29*
  - Selecting *29*
- Dump One/All *71*

## E

- Echo *49*
- Envelope
  - Amplifier *40*
  - Filter Amount *45*
  - Introduction to *74*
- Expression Pedal *17*

## F

- Filter
  - Introduction to *73, 79*
  - Triggering Envelope via MIDI *62*
  - Type *42*
  - Velocity *25*
- Fine Tune *38*
- FM Amount *39*
- Frequency (Filter) *44*
- Frequency Modulation *39*

## G

- Gain *41*

## H

- Headphone *7*
- Highpass *43, 80*
- HP 24dB *43*

**K**

- Kbd Track (Keyboard Tracking)
  - Filter 46
  - Osc 2 39

**L**

- L out 7
- Layering 13
- Layers
  - Playing via MIDI 69
- Legato 53
- LFO 1 47
- LFO 1, Synchronizing to MIDI Clock 61
- LFO 2 48
- LFO 2, Synchronizing to MIDI Clock 62
- LFO, Introduction to 74
- Local (Control) 58
- Lowpass 42, 80
- LP 43
- LP 12dB 42
- LP 24 dB 43

**M**

- Manual 22
- Master Tune 16
- MIDI 59
- MIDI Channel
  - Global 60, 68
  - Program Slot 59
  - Program slot 68
  - With Sequencer 69
- MIDI Connections 7, 69
- Modulation Envelope 50
- Modulation wheel
  - Destination 52
  - Morphing From 28
  - Using 15
- Mono
  - Mode 15, 53
  - Out Mode 57
  - Output 15
- Morphing 28, 52

**N**

- Noise 38
- Notch+LP 44

**O**

- Octave Shift 54
- Oscillator 1 37
- Oscillator 2 38
- Oscillators, Introduction to 73
- Out Mode 15, 57
- Outputs 7

**P**

- PCMCIA Cards 24
- Pedal
  - Connecting 8
  - MIDI Transmission and reception 67
  - Morphing 28
  - Setting Up 17
- Performances
  - Defined 36
  - Editing 34
  - Introduction to 33
  - MIDI Transmission and reception 68
  - Recalling 14, 33
  - Saving 35
- Pitch Bend, *see Pitch Stick*
- Pitch Stick
  - MIDI Transmission and reception 67
  - Range
  - Using 15
- Poly 15, 53
- Portamento 54
- Prog/Ctrl 59
- Program Change
  - Activating transmission/reception 59
  - Described 68
  - Recording in Sequencer 70
- Program Slots
  - Introduction to 11
- Programs
  - Copying 23
  - Editing 21
  - Layering 13
  - MIDI Channel 68
  - MIDI Transmission and reception 68
  - Selecting 11
  - Selecting in a Performance 34
  - Storing 23
- Pulse Width 40



**R**

- R out 7
- Rate
  - LFO 1 47
  - LFO 2 48
- Release
  - Amplifier 41
  - Filter 46
  - Introduction to 86
- Resonance 45

**S**

- Semitones 38
- Shift Functions 55
- Special Functions 61
- Stereo
  - Out Mode 57
  - Output 15
- Store
  - Performance 35
  - Program 23
- Sustain
  - Amplifier 41
  - Filter 46
  - Introduction to 85
- Sustain Pedal 17
- Sync 39, 78
- System 66
- System Exclusive
  - Bulk Dump 71
  - Implementation 91

**T**

- Tune 16, 57

**U**

- Unison 53
- Unison Detune 66

**V**

- Velocity
  - Morph via MIDI 64
  - Programming 25
  - to Filter 46

**W**

- Waveform
  - LFO 1 47
  - Osc 1 37
  - Osc 2 38

