

Introduction.....	2	Advanced Features.....	34
Using this Manual.....	2	Oscillator Menu.....	34
Main Features.....	2	Mixer Menu.....	37
Conventions used in this Manual.....	2	Filter Menu.....	37
		LFOs Menu.....	38
Quick Start Guide.....	3	Envelopes Menu.....	39
Connecting to audio and MIDI equipment.....	3	The Effects Menus.....	41
Listening to the factory preset sounds.....	3	Delay Menu.....	41
Selecting Programs and Drum Maps.....	3	Reverb Menu.....	42
Selecting Performances.....	4	Chorus Menu.....	43
Editing a sound.....	5	Distortion Menu.....	44
Saving a sound.....	6	EQ Menu.....	45
Editing a Performance.....	7	Panning Menu.....	46
Saving a Performance.....	8	Vocoder Menu.....	46
Listening to the factory demonstration.....	8	Other Menus.....	47
		Wheels Menu.....	47
Synthesis Tutorial.....	9	Aftertouch and Breath Menu.....	48
Elements of a sound.....	9	Utilities Menu.....	49
Oscillators and waveforms.....	9	Global Menu.....	50
The Mixer.....	11	Synchronisation Menu.....	52
The Filter.....	11	Arpeggiator Menu.....	53
Envelopes and Amplifier.....	12	Part Edit Menu.....	55
LFOs.....	13	MIDI Specification.....	56
Memories.....	14	MIDI Program Changes and Bank Select.....	56
Summary.....	14		
MIDI Tutorial.....	15	Appendix.....	57
About MIDI.....	15	MIDI Implementation Chart.....	57
MIDI messages	15	KS Rack Factory Preset Program Listings.....	58
MIDI and Sequencers.....	17	KS Rack Factory Preset Performance Listings.....	60
Summary.....	17	KS Rack Factory Drum Bank Listings.....	61
		MIDI Controller List.....	62
Main Features and Operation.....	18	MIDI NRPN List.....	64
Front Panel Layout.....	18	Packed Controller / NRPN Details.....	65
Modes and Menus.....	19	MIDI System Exclusive.....	66
Oscillator Section.....	22	Safety notice, CE and FCC Approvals	73
Mixer Section.....	23	Technical Specification.....	74
Filter Section.....	24		
LFOs Section.....	25	Index.....	75
Envelopes Section.....	26		
Volume, Headphones and Audio Input Section.....	26		
Effects Section.....	27		
Arpeggiator Section.....	28		
Hypersync Section.....	29		
Part Edit Section.....	31		
Display and Data Entry Section.....	32		
Mode and Keypad Section.....	33		

Using this Manual - Main Features - Conventions used in this manual

Thank you for purchasing the Novation KS Rack Synthesizer.

This instrument is a multi-timbral, enhanced version of the popular K-Station keyboard synthesizer. The design of the has evolved from the K-Station and KS 4 / KS 5, using the very latest award-winning Novation technology found in highly-acclaimed products such as Nova and Supernova II. The KS Rack is capable of producing an enormous range of high quality synthesized sounds and is an ideal machine for a home studio set-up or for an experienced producer looking to add an extra dimension of sound power.

Using this Manual

This manual consists of six sections, **Introduction**, **Quick Start Guide**, **Synthesis Tutorial**, **MIDI Tutorial**, **Main Features and Operation**, and **Advanced Features**. For easy reference, the section name is printed at the top of each page. An **Appendix** on the final pages lists all menu options and factory preset sounds list.

In order to become an expert user as quickly as possible, it is recommended that this manual is read in sequence chapter by chapter. If sound synthesis is an unfamiliar subject, then the chapter **Synthesis Tutorial** will provide a useful introduction to the techniques used to electronically simulate the sound of a musical instrument using an analogue music synthesizer.

Another chapter, **MIDI Tutorial** provides a useful introduction to the subject of MIDI and how it is used for communication between instruments and / or sequencers. The chapter also describes how the KS Rack transmits and recognizes various types of MIDI messages.

If the general principles of Sound Synthesis and MIDI are already familiar, then the Quick Start Guide is the place to begin. Once familiar with the main features of the machine, the Advanced Features section covers the Effects, Arpeggiators, Synchronization, Triggering and the Utilities, and will provide all of the information needed to operate the KS Rack in the most creative, productive way. Have fun !

Main Features

Four hundred Program memories

Two hundred factory programmed sounds are included and a further two hundred user sound memory locations are provided (factory programmed sounds may be overwritten).

One hundred Performance memories

Fifty factory programmed multi-timbral Performances are included and a further fifty user Performance locations are provided (factory programmed Performances may be overwritten).

Each Performance can consist of up to four different Programs, each with its own unique effects settings, MIDI channel assignments and keyboard settings. Program data for each Performance Part are stored in the Performance memory location.

Four Drum Maps

Two factory programmed Drum Maps are included with a further two user Drum Maps available (factory programmed Drum Maps may be overwritten).

Drum Maps allow a whole drum kit to be mapped across 49 notes of the keyboard with each drum sound available on a different key. Drum Maps consume only one unit of Multi-timbrality.

Powerful Oscillators

Three Oscillators provide the standard Sawtooth, Square, Variable Pulse, Triangle and Sine waves. Additional sampled waveforms are also available, each containing complex audio information not available in the standard waveforms.

The Sawtooth, Triangle and Sine waveforms may be duplicated within a single Oscillator to provide thicker sounding waveforms. Synchronization and FM between two Oscillators allow the generation of metallic or percussive timbres. A four section noise source completes the waveform engine.

External Audio Input

The Mixer allows an external audio signal to be combined with the Oscillators and processed through the Filter, Envelopes and Effects. Envelopes may also be auto-triggered by an external signal.

Vocoder

The 16 band Vocoder makes it easy to create Robot and Talky sound effects.

Four Arpeggiators

The arpeggiator features six different operational modes with adjustable gate time for staccato effects. Thirty two rhythmic patterns are available to introduce complex motion effects. In multi-timbral Performance Mode, up to four arpeggiators are available simultaneously, each with their own unique settings. All four arpeggiators can be individually synchronised to MIDI Clock at different time signatures.

HyperSync

Sixteen 'Hypersync' templates provide fast, effective, musically synchronized settings with a simple twist of a control.

When selected, synchronisation settings to four Effects and four Program parameters are instantly applied. Settings for the Delay level, Chorus Level, Panning Depth and EQ Modulation Depth are also applied.

Using these tempo synchronized features can significantly enhance music production.

Comprehensive MIDI Control Specification

Adjustments of any controls transmit MIDI Controller numbers or NRPNs for real time recording by a sequencer or computer.

Powerful Effects

The effects processor includes Distortion, Stereo Chorus, Phaser, Reverb, Synchronized Delay and Synchronized Stereo Panning. Complex, dynamic timbres may be created using tempo synchronized effects settings. A final output EQ and Filter section complete with a tempo synchronized LFO allow for a performance to be automatically filtered and time locked from 32nd triplets through to several bars.

In multi-timbral Performance Mode, each of the four individual Parts can have its own unique Effects settings.

Data Compatibility

The KS Rack has been designed to allow the loading of Sysex data dumps from the Novation K-Station and A-Station. This ensures that existing sound libraries and global settings can easily be transferred from the older types of machine. Data is also fully compatible with the Novation KS 4 and KS 5 synthesizers.

Conventions Used In This Manual

The word 'Program' refers to a collection of knob and switch settings that define an individual 'Sound'. These settings are then saved as a 'Program' which has a corresponding name and number in the machine's non volatile memory.

Throughout this manual the two words, 'Sound' and 'Program' are frequently referred to and essentially have the same meaning.

The term 'Drum Map' refers to a whole kit of drum sounds which are mapped across the keyboard, with each keyboard note triggering a different drum sound.

The word 'Performance' refers to a multi-timbral setting where up to four Programs and/or Drum Maps are available for playing simultaneously. This entire arrangement is then saved as a 'Performance' which has a name and number assigned in the machine's non-volatile memory.

Each of the four Programs / Drum Maps making up a Performance is referred to as a 'Part'.

The word 'Preset' refers to a Program/Performance/Drum Map which was set up at the factory to showcase some of the KS Rack's powerful sound possibilities. Preset memories may actually be overwritten with new settings, but it is possible to restore them to the original factory set Programs, Drum Maps or Performances by loading in a MIDI file if they have been overwritten by mistake.

QUICK START GUIDE

Connecting audio equipment - Listening to preset sounds - Selecting Programs

Text in CAPITALS refer to a front panel control or legend (even though the name of the control may actually be in lower case on the front panel). It could be a knob or button. For example, FREQUENCY refers to the Filter frequency control knob. MENUS refers to the Menu Mode button.

The fastest way to become familiar with the product is to follow this quick start guide. It covers connecting up to audio equipment, listening to the factory preset sounds, selecting sounds, editing a sound and saving a sound into a memory location.

Connecting to Audio and MIDI equipment

Before connecting to other units in the system, ensure the power to all units is off. Connect an audio cable from the Left and Right master output sockets to a suitable amplifier or mixing desk stereo inputs. If MONO operation is required, either output may be used.

Connect the power cable to the socket 'Power In' and connect the cable to the AC mains. Switch on the power. The display will show the name of the last selected Program, Drum Map or Performance and its number.

Select **Program Mode** by pressing the PROG button.

Finally, switch on the other units in the Audio system (amplifier, mixer etc.).

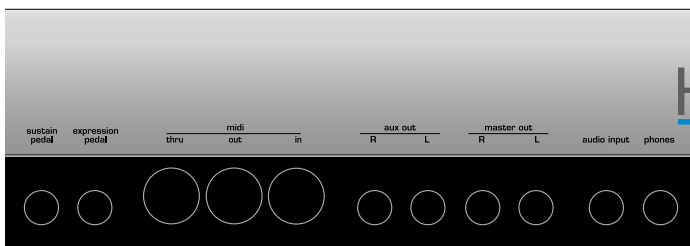

Listening to the factory preset sounds

Set the VOLUME control to a reasonably high output level. This will maintain a good signal to noise ratio. Make sure that the input volume setting on the system amplifier or mixer is initially set to zero.

On leaving the factory, the KS Rack is set to receive MIDI information on Channel 1, so, if using an external master keyboard or sequencer to trigger the sounds, ensure that it is set to transmit on this MIDI channel.

Playing a connected master keyboard or sequencer will result in the currently selected factory preset sound being heard.

A full listing of the factory preset Programs, Drum Maps and Performances can be found on page 59. The first few locations of the user Programs in bank 3 (Program Number 300 onwards) contain initialisation examples. These are also described in the list.

On leaving the factory, the KS Rack has been configured to automatically select Performance 100 once it is turned on (It is possible to override this so that the KS Rack automatically selects the Program, Drum Map or Performance of your choice - see page 50).

The first 50 Performances have been configured at the factory to showcase some of the impressive features available on the KS Rack. To inspect the factory set Performances, refer to the Selecting Performances section of this manual on page 4. These Performances are listed in detail on page 60.

Selecting Programs and Drum Maps

There are two main modes of operation - **Program Mode** where the machine is mono-timbral (only one type of sound is available for playing) and **Performance Mode** where the machine is four Part multi-timbral (up to four different sounds can be played simultaneously).

Program Mode is selected by pressing the PROG button. The LED above the button lights to confirm that Program Mode is selected. The standard Program Mode display will be shown.

```
Program's name  101
Category Name
```

Program Mode is convenient for auditioning individual sounds.

Standard Programs are organised into four banks, each bank containing 100 sounds. These are referred to as banks 1, 2, 3 and 4.

Bank 1	100 - 199	- First bank of factory preset sounds
Bank 2	200 - 299	- Second bank of factory preset sounds
Bank 3	300 - 399	- First bank of user sounds
Bank 4	400 - 499	- Second bank of user sounds

The next four banks contain four Drum Maps. Drum Maps are whole kits of percussion sounds, each sound corresponding to an individual note on the keyboard. A Drum Map is a 'batch' of 49 Programs. Each of these sounds has been programmed to closely immitate the sound of a real or electronic type of percussion sound, be it a Bass Drum, Snare Drum etc.

Following the 49th Drum Map Program is an extra Program containing the Effects settings used by the Drum Map as a whole.

A Drum Map may be selected at any time by pressing the DRUM EDIT button. The last selected drum bank will then be available on the keyboard to audition.

When any Program in a Drum Map is selected, all other Programs located in the same Drum Map are also available for playing on the keyboard.

To return to a normal Program, select a program between 100 and 499

The Drum Maps available are :

Bank 5	500 - 549	- First factory preset Drum Map
Bank 6	600 - 649	- Second factory preset Drum Map
Bank 7	700 - 749	- First user Drum Map
Bank 8	800 - 849	- Second user Drum Map

There are four methods of selecting Programs, Drum Maps or Performances. Before using any of the methods, Ensure that a Menu is not active (the LED above the MENUS button must not be lit). If a Menu is selected, press the PROG button to select **Program Mode**.

1 - Using the 0 - 9 Keypad buttons

There must always be a three digit entry on the numeric keypad, for example : To select Bank 1 sound 8, press the **1**, **0** and **8** buttons. The display will now show the name of the newly selected sound and indicate that sound **108** has been selected.

2 - Using the PAGE buttons

The PAGE buttons may be used to move up or down to the next Program. Pressing and holding either button for a short period will cause the Program / Performance number to advance / decrease by a further 9.

3 - Using the PERF / PROG / DATA knob

The DATA knob may be used to move up or down to the next Program. Turning the knob slowly will advance the selection by one by one. Turning the knob more quickly will increase the rate of selection.

If the the end of a Program bank has been reached, the first Program of the next bank will be selected, for example Program 199 moves to Program 200.

Selecting Programs - Selecting Performances

Each Program is assigned to a category. Categories are used to classify a Program that belongs to a sound group such as Bass sounds, String sounds, Lead sounds etc.

It is possible to use the DATA knob to search for sounds within a specific category. This is a convenient way of auditioning all sounds that belong to a specific category.

To search for a Program within a category, press the BY CATEGORY button. The LED above the button is lit while category searching is enabled.

```

Program's name  101
Bass
    
```

Using the DATA knob selects the next Program assigned to the same category. In the above example the next Bass type of Program will be selected.

When category searching is enabled, the default category is whatever category was assigned to the Program when it was originally saved (see Page 6). To search under a different category, use the SELECT left and right buttons.

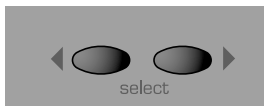

After pressing one of the SELECT buttons, a new category is displayed

```

Program's name  101
Strings
    
```

The first Strings Program will not be located until the DATA knob is used to search for the first Strings Program. If no Programs exist using the current category, 'NO PROGRAMS' will be displayed as the Program's name, but the previously selected Program will still be available.

Category searching is cancelled by pressing the BY CATEGORY button again, whereby the LED above it will extinguish.

4 - Using MIDI Program Change commands

A MIDI Program change message sent from an external sequencer or controller keyboard will select the appropriate Program or Performance within the currently selected bank.

A MIDI Bank Change message (CC32) received along with a Program change message will select the appropriate Program or Performance within the bank specified by the Bank Change message.

If Bank Change messages are used, it is recommended that the Bank Change message is sent *immediately* before the Program Change message. In Program Mode, A Bank Change value of 1 is used to select Bank 1, a value of 2 is used to select Bank 2 etc.

A full table of the bank values used is found on page 56 along with details on how they should be used.

Whenever a new Program or Performance is selected from front panel, both Bank Change and Program Change are transmitted via MIDI Out. It is sometimes convenient to record these messages into a sequencer in real-time.

Selecting Performances

Performances are multi-timbral arrangements where up to four separate Programs or Drum Maps are available for playing simultaneously.

A bank of 100 Performances is available. The first 50 performances have been preset at the factory and showcase the various layering, keyboard splits and multi-timbral arrangements available. The remaining 50 performances are blank user locations.

Performance Mode is selected by pressing the PERF button. The LED above the PERF button lights to confirm selection. The standard Performance Mode screen is displayed.

```

Performance name 101
123  234  345  456
    
```

The cursor is positioned at the Performance number adjacent to the Performance's name. (Performances are numbered 100 to 199). At this position, selection of Performances is achieved in a similar manner to selecting Programs by means of the Keypad buttons, the PAGE buttons, or the DATA knob.

The BY CATEGORY button cannot be used to select Performances.

The four sets of numbers beneath the Performance name refer to the Program numbers that are allocated to each of the parts within the Performance. The illustration below shows the relationship between Performances, Parts and Programs.

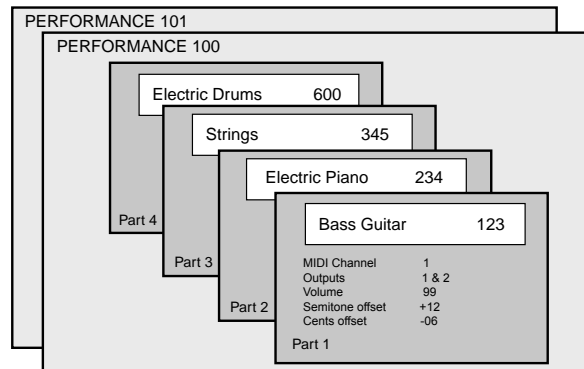

Up to 100 Performances may be saved in the KS Rack. The first 2 are shown in the above illustration - Number 100 and 101. Held in the Performance are up to 4 part 'slots'. These may have any one of the 400 single Programs selected for each one. For versatility, other information such as MIDI channel, note range etc. is also held in each part along with the program number.

Selecting / Changing the Programs on a Part in a Performance

The SELECT left and right buttons are used to select the Part where the Program is held. Once selected it may be changed or edited.

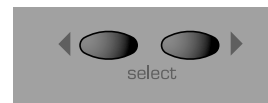

Press the SELECT left button. The cursor will move to the Program number assigned to Part 1 of the Performance. Subsequent presses of the SELECT left and right buttons will move to the next Program number across the bottom line of the display.

```

Performance name 101
123  234  345  456
    
```

The KEYPAD buttons, PAGE up / down buttons and DATA knob may also be used to select a new Program number on the selected Part.

The BY CATEGORY button may be used to select a Program in the same way as previously described. To return to selecting a Performance, press the PERF button.

Any changes made are temporary until the Performance is written into memory. Using and Editing Performances is covered in more detail on page 7.

Editing a Single Program (sound)

Editing Programs

Once familiar with the sounds that are available, select **Program Mode** (selected by pressing the PROG button), to select Program number 499. This is a very basic synthesizer sound which can be used as a starting point to create a new, more interesting sound for your own use.

When this sound is played from the keyboard, it will be noticed that the volume of the sound instantly reaches its maximum level when a key is pressed, and dies away instantaneously as soon as the key is released. The most useful editing controls on the KS Rack are found on the front panel and some of these will be used to modify (edit) this basic program.

While playing the keyboard, adjust the Amplifier Envelope SUSTAIN control. Notice how that the sound level when holding a key down changes. Set this control to just over half. Now adjust the RELEASE control. Notice how, when a key on the keyboard is released the sound will now gradually die away.

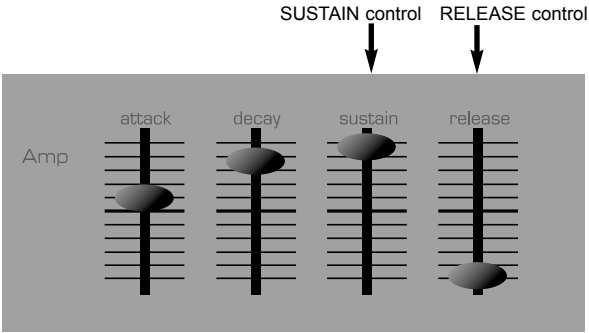

How quickly the sound dies away depends on the setting of this control. The sound is still a little too bright. Adjust the FREQUENCY control in the filter area. Notice how the sound becomes softer as the control is rotated anticlockwise. Continue to make adjustments until a desired sound is heard. The first small edit is now complete!

The edited Program must now be saved into a memory location if it is to be needed for the future.

Editing Drum Maps

Editing Drum Maps sounds is similar to editing Standard Programs. It is sometimes convenient to think of Drum Maps as whole batch of special Programs (the four Drum Maps available are numbered as Program Banks 5, 6, 7, & 8). However, there are some important differences to bear in mind when editing Drum Maps.

1) Whenever a sound is selected from a Drum Map, all other sounds located within the same Drum Map are immediately available for playing on the keyboard. Each keyboard note triggers a different percussion sound within the same Drum Map.

The keyboard notes used to trigger a sound depend on the Program's program number within the Drum Map. For example, Drum Map Program 500 is always triggered by the lowest note, (C) Drum Map program 501 by the next note upwards and so on.

2) It is the sound selected within the Drum Map *which determines which sound within the Drum Map is available for editing on the front panel*. Only one Drum Map Program can be edited at a given time. See the following paragraphs.

3) In a Drum Map, there is only one set of Effects available. All sounds in the Drum Map share the same single set of Effects settings. Therefore, altering any Effect while a Drum Map sound is selected will simultaneously affect all other sounds within the same Drum Map. To edit a Drum Map sound, press the DRUM EDIT button.

The Drum bank previously selected (bank 500 when shipped from the factory) will now be available to play across the keyboard.



To edit a specific sound in the Drum Map, hold down the DRUM EDIT button and press the key that corresponds to the sound to be edited.

It is only possible to select a single Drum sound in a Drum Map for editing at any one time. If another Drum Program is selected before the previously selected one is written to memory, any edits previously made will be immediately lost.

Once a drum sound has been selected, it can be edited in the same way as a standard Program. This flexibility means that a great many new Drum or Percussion type sounds may easily be created.

Any edits made will only become apparent when the currently selected Drum Program is triggered from the keyboard. All other drum sounds will remain unaffected. The exception is a change to any Effects settings (Chorus, Delay, Pan etc). These are applied to *all* sounds within the Drum Map.

When the standard Program Mode display is shown (available at any time by pressing the PROG button), an asterisk before the Program's location number indicates whether the Program / Drum Map has been edited in some way. For example :

```
Program's name *101
Drums
```

Saving a sound

Saving a sound

Single sounds (standard Programs or Drum Map Programs) may be saved in any memory location from 100 to 849.

It is recommended that the user locations are used early on for saving new sound creations. These are Banks 3 & 4 (locations 300 to 499) for standard Programs or Banks 7 & 8 (locations 700 to 899) for Drum Map Programs.

The factory preset sounds in Banks 1, 2, 5 and 6 may also be overwritten if desired. Once these factory presets are overwritten, they may only be retrieved by loading in a Sysex dump. (See page 49 for saving a sysex backup of the factory preset or user programs onto an external MIDI sequencer).

It is possible to write a standard Program to a location within a Drum Map or to write a Drum Map Program to a location within a standard Program bank.

When a standard Program is imported into a Drum Map, the Program will only be available by playing a single key on the keyboard (determined by the destination Program number within the Drum Map). Effects settings of the original Program are not copied across.

If a Drum Map Program is written to a standard Program location, the drum sound in question will now be available for playing across the entire keyboard. (the audible results however may not be that satisfying). Effects settings of the original Drum Map are copied across.

NOTE: When shipped from the factory, the global memory protect switch is set to on. The memory protect switch is a safety feature designed to prevent memories from being overwritten by accident. In order to save a sound, the global memory protect must be switched off.

If an attempt is made to save to a memory while the global memory protect is still switched on, a brief warning message will be displayed.

Memory Protect On !

No data will have been written to memory.

Switching off Global Memory Protect

Press the MENUS button. The LED above the MENUS button will now light, indicating that **Menu Mode** is selected. Select the Global Menu by pressing the '0' button on the 0 - 9 numeric keypad. If necessary, use the PAGE buttons (immediately to the left of the display window) to scroll up and down the pages within the menu until the display shows **Mem Protect** and its current setting (**ON** or **OFF**). Use the DATA knob to turn memory protect **OFF**.

Exit Menu Mode either by pressing the MENUS button again or by pressing the PROG button. (the LED above the MENUS button extinguishes, indicating that Menu Mode is no longer active).

To save a Program to a memory location

Press the WRITE button.

Write Program to
DestProgName 499

The display will now show the destination memory number where the Program is about to be saved to. In this example, **Write to 499**. Notice that the destination memory is always initially set to the currently selected Program's number.

It is possible to save a Program to a different memory location. Use the PERF / PROG / DATA knob or Keypad buttons to select a different destination memory if required. Any location within the Standard Program banks or Drum Maps can be selected.

Shown on the bottom line of the display is the name of the Program currently located in the destination memory.

Press the WRITE button again.

Name Program
'DestProgName'

On this display it is possible to edit the Program's name. Use the Left and Right SELECT buttons to move the cursor within the Program's name text. Use the PERF / PROG / DATA knob to edit the character located at the cursor.

Press the WRITE button again.

Set Program Category
Bass

On this display, the category of the Program can be set. Setting a category allows the category search feature (see pages 4 & 32) to easily find specific types of sounds easily. There are 17 different categories available.

Categories	
No.	Description
0	Bass
1	Arpeggio
2	Motion
3	Dance
4	Pad
5	EP/Clav
6	Strings
7	Brass
8	Organ
9	Sweeps
10	Soft Lead
11	Hard Lead
12	Bells
13	SFX
14	Vocoder
15	Ex Aud Trig
16	Drums

To complete the saving procedure, press the WRITE button again (display flashes PROGRAM SAVED). This saves the edited Program to memory and once the sound has been written **Program Mode** will be selected.

At any point in the saving procedure, the COMPARE button can be used to audition the Program located at the destination memory. This feature can be useful in helping to avoid over-writing a Program memory containing wanted data.

While the COMPARE button is held, the currently edited Program buffer is replaced with the Program located at the saving destination memory. This destination Program can be played from the keyboard. As soon as the COMPARE button is released, the Program buffer is restored complete with any edits previously made.

Editing a Performance

Performance Mode is equivalent to using four KS Rack machines, each playing in Program Mode. Performance Mode enables the machine to be used multi-timbrally. Up to four different Parts (slots that contain programs) can be used and played simultaneously. Performances can be configured in a number of different, interesting ways.

Performance Mode is selected by pressing the PERF button. The LED above the PERF button lights to confirm selection. The standard Performance Mode screen is displayed.

```
Performance name 101
123 234 345 456
```

The cursor is positioned at the Performance number adjacent to the Performance's name. (Performances are numbered 100 to 199). At this position, selection of Performances is achieved in a similar manner to selecting Programs by means of the Keypad buttons, the PAGE buttons, or the DATA button.

Editing Parts

To edit a single part in the performance, press the Part EDIT button corresponding to the Part (that contains the Program) to be edited or press the SELECT left and right buttons until the cursor is beneath Program number to be edited. The LED above the Part's EDIT button lights.

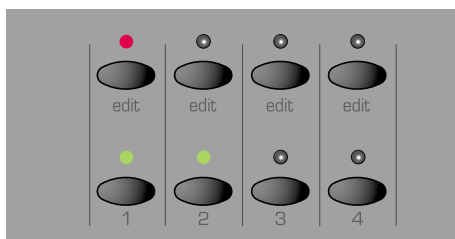

At all times, one of these EDIT buttons will be selected. When the MIDI channel is different on each Part (In multi-timbral configuration), the EDIT buttons determine which Part(s) will be heard when the keyboard is played.

The bottom row of buttons indicate which of the four Parts is used by the Performance. Any combination of the four available Parts is possible. A green LED above the button indicates whether the Part is 'active' (used by the Performance).

When a Performance is written to a memory location, the status of these eight buttons are stored.

Part Layering

Two or more Parts may be played simultaneously on the keyboard. Layering Parts enables even richer sound textures to be easily created.

To create a layer, Press the MENU button under the Part Level knob. Use the PERF/PROG/PAGE up or down keys to select the MIDI channel page in the Menu. Use the PERF/PROG/DATA to set the MIDI channel to the same number for each part used for the layer.

While Parts are layered together, it is possible to dynamically switch between them while playing, determining which Part(s) are heard by using the keyboard's note velocity (ie how hard the keyboard note was played). Velocity cross fades are possible. See page 55 for more details on this.

Keyboard Splits

Each Part may have its own area of the keyboard assigned to it. It is possible to assign the whole keyboard range to a part, just a single note or any range in between. The keyboard ranges of different Parts are allowed to overlap by any amount, so many interesting arrangements are possible.

To create a split, Press the MENU button under the PART LEVEL knob. Use the PERF/PROG/PAGE up or down keys to select the PART Low Note or PART High Note page in the Menu. Use the PERF/PROG/DATA to set the high or low note. While in each part Menu ensure the MIDI channel is set to the same number.

When Keyboard-split Parts share the same MIDI channel, they can all be accessed at once by playing the keyboard.

Multi-timbral

The term multi-timbral means 'more than one sound type'. It is possible to configure the machine such that 'more than one sound type' can be played at the same time.

In this configuration, each Part has its own unique MIDI channel setting. This is the ideal arrangement for use with an external sequencer, where each Part can be controlled and played individually.

To create a multi-timbral configuration, it is only necessary to have a different Program (sound) allocated to each of the parts and for it to have a different MIDI channel number.

Combinations of the above arrangements are also possible. For example, it is possible to have two Parts layered together, while another Part is assigned to different area of the keyboard and a fourth Part is set to use a different MIDI channel altogether.

The Part Edit section on the front panel is used to determine which Part(s) are used by the Performance and which Part(s) can be edited using the front panel controls.

Saving a Performance - Listening to the factory demonstration

Saving a Performance

Once a Performance has been edited, it must be saved into a Performance memory if it is to be recalled for future use.

Saved along with the Performance data are the complete Program data contained in each of the four Performance Parts. When a Performance is saved, **the original versions of the Part Programs in the Program Mode memory locations are NOT over-written.**

If a Part contains a Drum Map, only the effects settings for that Drum Map are saved in the Performance.

Performances may be saved in any Performance memory location from 100 to 199. It is recommended that the user locations are used early on for saving newly created Performances. These are locations 150 to 199.

The factory preset Performances in locations 100 to 149 may be overwritten if desired. Once these factory presets are overwritten, they may only be retrieved by loading in a Sysex dump. (See Page 49 for saving a sysex backup of the Performances to an external MIDI sequencer).

NOTE: When shipped from the factory, the global memory protect switch is set to on. The memory protect switch is a safety feature designed to prevent memories from being overwritten by accident. Therefore, in order to save a Performance, the global memory protect must be switched off. See page 6 for details on how to do this.

If an attempt is made to save to a memory while the global memory protect is still switched on, a brief warning message will be displayed.

```
Memory Protect On !
```

No data will have been written to memory.

To save a Performance to a memory location

Press the WRITE button.

```
Write Performance to
DestPerfName      199
```

The display will show the destination memory number where the Performance is about to be saved to. In this example, **Write to 199.**

Notice that the destination memory is always initially set to the currently selected Performance's number. It is possible to save a Performance to a different memory location. Use the PERF / PROG / DATA knob or Keypad buttons to select a different destination memory if required.

Shown on the bottom line of the display is the name of the Performance currently located in the destination memory.

Press the WRITE button again.

```
Name Performance
'DestPerfName'
```

On this display it is possible to edit the Performance's name. Use the SELECT Left and Right buttons to move the cursor within the Performance's name text. Use the DATA knob to edit the character located at the cursor.

To complete the saving procedure, press the WRITE button again. This saves the edited Performance to memory (display flashes PERFORMANCE SAVED) and once it has been written, **Performance Mode** will be selected

To save (Export) an individual Program on a Part in a Performance back to an ordinary Program

In Performance Mode it is possible to save (export) any of the Programs contained within the Performance's four Parts back to an ordinary Program bank memory location from 100 to 849.

One of the outstanding features of the KS Rack is that a complete new set of programs are held in each part in performance mode IN ADDITION TO THOSE HELD IN THE SINGLE PROGRAM MEMORIES 100 - 849. Therefore any modifications of programs held in a part in a performance WILL NOT alter any of the programs in the normal single program memories 100 - 849.

When tweaking a performance it is useful to be able to export a program out of a performance back to a single memory location. This can then be used in another performance if necessary.

Select Performance Mode by pressing the PERF button.

```
Performance name 101
123 234 345 456
```

Press the WRITE button to start the saving procedure.

```
Write Performance to
DestPerfName      101
```

Press the EDIT button in the Parts section that corresponds to the part that the program is to be exported from. In this example the desired program is being used on Part 2, so press the Part 2 EDIT button. The display changes to :

```
Export PART to Prog
This Program      234
```

The program destination (234 in this example) can be kept or changed using the DATA knob, PAGE UP/DOWN buttons or 0 - 9 keypad.

A press of the write button then prompts for a new program name to be entered if required.

A further press of the write key prompts for a category and a final press saves the exported program.

Listening to the factory demonstration

To complete this Quick Start Guide section, some time spent listening to the sounds that the KS Rack is capable of producing will be of benefit when it comes to creating new sounds.

Press the MENUS button - the LED above the button will light. Now simultaneously press the both the keypad 1(osc's) and 2(filter) buttons. The Factory demonstration will begin to play. Once the demonstration has finished, the previously selected mode will be active.

It is possible to stop the demonstration at any time while it is playing by pressing the PROG or PERF button to return immediately to **Program Mode** or **Performance Mode**.

It is recommended that this chapter is read carefully if Analogue sound synthesis is an unfamiliar subject. Users familiar with this subject can skip this chapter and move on to the chapter - **MIDI Tutorial** on Page 15.

Elements of a sound

To gain an understanding of how a Synthesizer generates sound it is helpful to have an understanding of the components that make up a sound, be it musical or non musical.

The only way that a sound may be detected is by air vibrating the eardrum in a regular, periodic manner. The brain interprets these vibrations (very accurately) into one of an infinite number of different types of sound.

Remarkably, *any sound* may be described by just *three terms*, and all sounds *always* have them. They are :

- * Volume
- * Pitch
- * Tone

What makes one sound different to another is the proportion of these three qualities initially present in the sound and how these three terms *change* throughout the duration of the sound.

With a musical synthesizer, we deliberately set out to have precise control over these three terms and, in particular, how they can be changed throughout the duration of the sound. These terms are often given different names, Volume is referred to as Amplitude, Pitch as Frequency and Tone as Timbre.

Pitch

Taking the example of air vibrating the ear drum, the pitch is determined by how fast the vibrations are. For an adult human, the lowest vibration perceived as sound is about twenty times a second, which the brain interprets as a bass type sound, and the highest is many thousands of times a second, which the brain interprets as an extreme treble type sound.

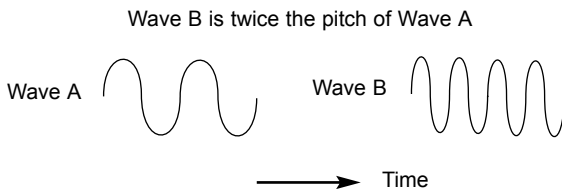

If the number of peaks in the two waveforms (vibrations) are counted, it will be seen that there are exactly twice as many peaks in Wave B as in Wave A. (Wave B is actually an octave higher in pitch than Wave A). It is the number of vibrations in a given period that determines the pitch of a sound. This is the reason that pitch is sometimes referred to as frequency. It is the frequency of the waveform peaks which are counted during a given period of time.

Tone

Musical sounds consist of several different related pitches occurring simultaneously. The loudest is referred to as the 'Fundamental' pitch and corresponds to the perceived note of the sound. Pitches related to the fundamental are called harmonics. The relative loudness of these harmonics compared to the loudness of all the other harmonics (including the fundamental) determines the tone or 'Timbre' of the sound.

Consider two instruments such as a harpsichord and a piano playing the same note on the keyboard and at equal volume. Despite having the same volume and pitch, the instruments would still sound distinctly different. This is because the harmonics present in a piano sound are different to those found in a harpsichord sound.

Volume

Volume, which is referred to as the amplitude or loudness of the sound is determined by how large the vibrations are. Very simply, listening to a piano from a metre away would sound louder than if it were fifty metres away.

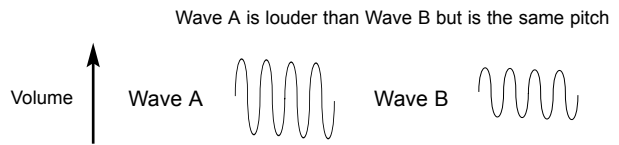

Having shown that just three elements make up any sound, these elements now have to be related to a Musical synthesizer. It is logical that a different section of the Synthesizer 'Synthesizes' (or creates) these different elements.

One section of the synthesizer, the **Oscillators** provide raw waveforms which provide the pitch of the sound along with its raw harmonic content (tone). These signals are then mixed together into a section called the **Mixer** and the mixed oscillator signal is then fed into a section named the **Filter** which is responsible for further altering the tone of the sound. It does this by removing (filtering) certain undesired harmonic frequencies. Lastly, the filtered signal is fed into a final section, the **Amplifier** which determines the final volume of the sound.

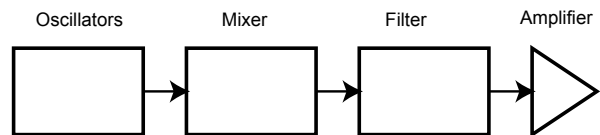

Audio path of the main Synthesizer blocks

Additional synthesizer sections; **LFOs** and **Envelopes** provide ways of altering the pitch, tone and volume of a sound by interacting with the **Oscillators**, **Filter** and **Amplifier**, providing changes in the character of the sound which can evolve over time. Because **LFOs** and **Envelopes** only purpose is to control (modulate) the other synthesizer sections, they are commonly known as 'modulators'.

These various synthesizer sections will now be covered in more detail.

Oscillators and waveforms

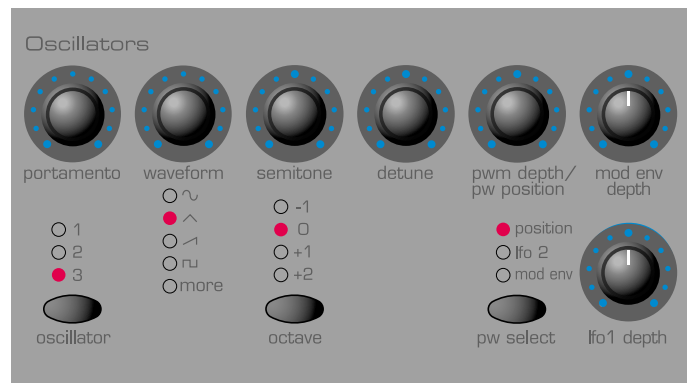

The Oscillator is really the heartbeat of the Synthesizer. It generates an electronic wave (which creates the vibrations). This *Waveform* is produced at a controllable musical pitch, initially determined by the note played on the keyboard or contained in a received MIDI note message. The initial distinctive tone or timbre of the waveform is actually determined by the wave's shape.

Many years ago, pioneers of musical synthesis discovered that just a few distinctive waves contained many of the most useful harmonics for musical synthesis. The names of these waves reflect their actual shape when viewed on an instrument known as an *Oscilloscope*, and are known as, Sine waves, Square waves, Sawtooth waves, Triangle waves and Noise Waves.

Each one has a specific fixed amount of musically related harmonics (except noise waves) which can be manipulated by further sections of the Synthesizer.

Oscillators and waveforms

The diagrams below show how these waveforms look on an Oscilloscope and illustrate the relative levels of their harmonics. Remember, it is the relative levels of the various harmonics present in a waveform which determine the tone of the final sound.

Sine waves

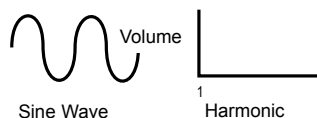

These have just a single frequency. This waveform produces the purest sound because it only has this single pitch (frequency).

Triangle waves

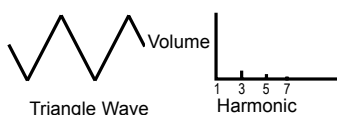

These contain only odd harmonics. The volume of each is the square of its position in the harmonic series. For example, the 5th harmonic has a volume of 1/25th of the fundamental.

Sawtooth waves

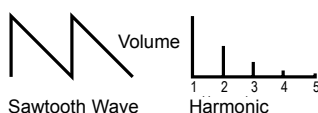

These have a rich proportion of harmonics, containing all the harmonics of the fundamental frequency. The volume of each harmonic is proportional to its position in the harmonic series.

Square waves

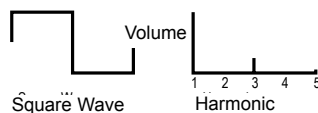

These only have only the odd harmonics present. These are at the same volume as the odd harmonics in a sawtooth wave.

It will be noticed that the square waveform spends an equal amount of time in its 'high' state and its 'low' state. The way in which this is defined is known as the 'duty cycle'. A square wave always has a duty cycle of 50% which means it is 'high' for 50% of the waveform cycle and 'low' for the remaining 50% of the waveform cycle.

On the KS Rack it is possible to adjust the duty cycle of the basic square waveform to produce a waveform which is more 'rectangular' in shape. These are often known as Pulse waveforms. As the waveform becomes more and more rectangular, more even harmonics are introduced and the waveform changes its character, becoming more 'nasal' sounding.

The width of the pulse waveform (often known as 'Pulse Width') can be altered dynamically by a modulator which results in the harmonic content of the waveform constantly changing. This can result in the waveform having a very 'fat' quality when the pulse width is altered at a moderate speed.

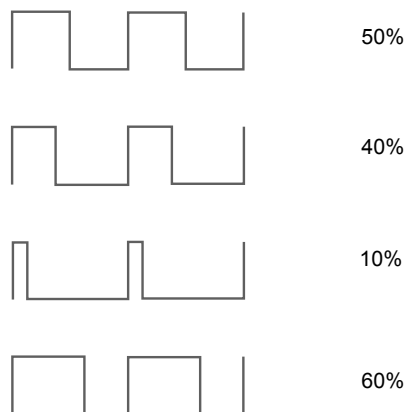

Various duty cycles of rectangular (pulse) waves

When listening to a pulse wave, it does not make any difference to the perceived sound whether the duty cycle is 40% or 60% since the waveform has just been inverted and the harmonic content between the two is exactly the same.

Noise waves

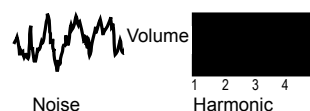

These have no fundamental frequency (and therefore no pitched element). All frequencies are at the same volume. Because they have no perceivable pitch, noise waves are often useful for creating sound effects and percussion type sounds.

Digital waveforms

In addition to the traditional types of Oscillator waveforms detailed above, the KS Rack also offers carefully selected digitally sampled preset waveforms containing useful harmonic elements normally difficult to produce using traditional Oscillator waveforms.

The Mixer

To extend the range of sounds that may be reproduced, a typical Analogue synthesizer often has more than one Oscillator. By using more than one Oscillator when creating a sound, it is possible to achieve very interesting harmonic mixes. It is also possible to slightly detune individual Oscillators against each other which creates a very warm 'fat' sound. There are three independent Oscillators and a separate Noise Oscillator.

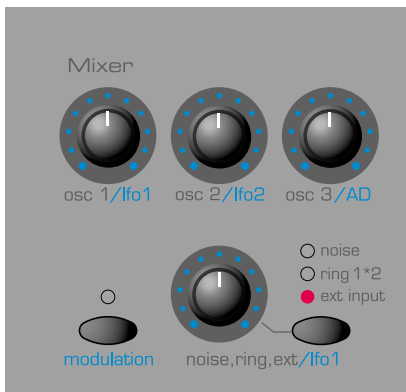

The mixer section is included so that the amplitude (volume level) of each of these Oscillators and Noise sources may be independently adjusted and mixed together to form a new more harmonically complex waveform.

As well as mixing together the individual Oscillators as shown in the diagram above, the mixer section allows the relative volume levels of the Noise Oscillator and any external sound source to be set.

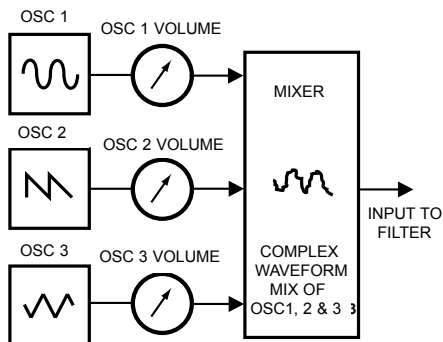

The Filter

The KS Rack is an *Analogue subtractive* type of music synthesizer. *Subtractive* implies that part of the sound is subtracted somewhere in the synthesis process.

The Oscillators provide the raw waveforms with plenty of harmonic content and it is the *Filter* that subtracts unwanted harmonics in a controllable manner.

Three types of Filter are available. The type of Filter most commonly found on synthesizers is the Low Pass type. With a Low Pass Filter, a cut-off point is chosen and any frequencies below that point are passed. Any frequencies above are filtered out. The setting of the FREQUENCY knob on the front panel dictates the point below which frequencies are removed. This process of removing harmonics from the waveforms has the effect of changing the sound's character or timbre. When the FREQUENCY knob is set fully clockwise, the filter is set completely open and no frequencies are removed from the raw Oscillator waveforms. In practice, there is a gradual reduction in the volume of the harmonics above the cut-off point. How quickly these harmonics are reduced in vol-

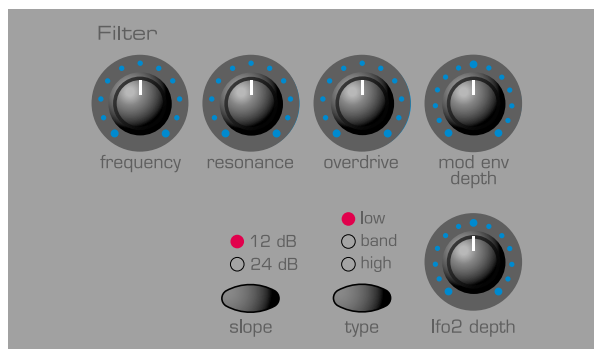

ume above the cut-off frequency is determined by the Filter's slope. This slope is measured in 'volume units per octave'. Since Volume is measured in decibels, this slope is quoted in number of decibels per octave (dB). Typical values are 12dB or 24dB per Octave. The higher the number, the faster the harmonics are cut and the more pronounced the filtering effect.

The button on the section marked SLOPE allows either the 12dB or 24dB type filter slope to be selected.

A further important feature of the Filter is the RESONANCE control. Frequencies at the cut-off point may be increased in volume by this control. This is useful for emphasizing certain harmonics of the sound.

As the RESONANCE is increased, a whistling like quality will be introduced to the sound passing through the filter. When set to very high levels, RESONANCE actually causes the filter to self-oscillate whenever a signal is being passed through it. The resulting whistling tone being produced is actually a pure sine wave, the pitch of which depends on the setting of the FREQUENCY knob (the filter's cut-off point). This resonance-produced sine wave can actually be used for some sounds as an additional sound source if desired.

The diagram below shows the response of a typical low pass filter. Frequencies above the cut off point are reduced in volume.

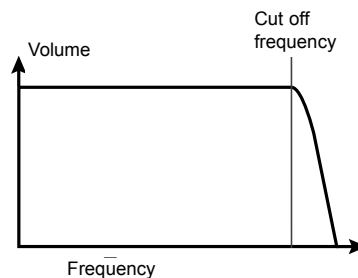

The Filter - Envelopes and Amplifier

When resonance is added, frequencies at the cut off point are boosted in volume.

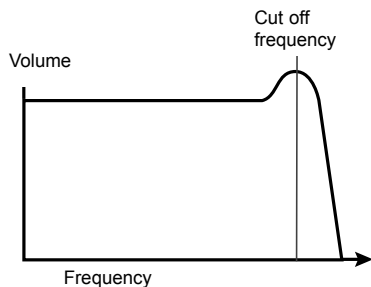

In addition to the traditional Low Pass Filter type, there is also a High Pass and Band Pass Filter. The type of Filter used is selected by using the front panel Filter TYPE button.

The High Pass Filter is similar to the Low Pass Filter except that frequencies *below* the cutoff frequency point are removed. Frequencies *above* that point are passed. When the FREQUENCY knob is set fully anti-clockwise, the filter is set completely open and no frequencies are removed from the raw Oscillator waveforms.

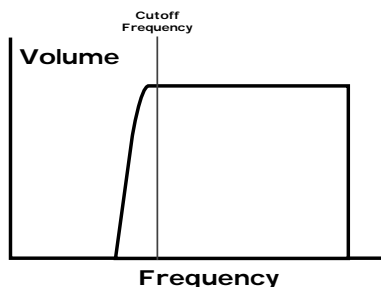

When the Band Pass Filter is used, only a narrow band of frequencies centered on the cutoff frequency point are removed. It is not possible to fully open this type of Filter, allowing all frequencies to pass through.

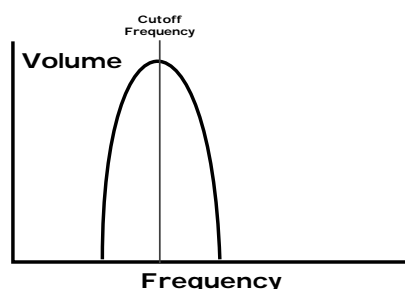

Envelopes and Amplifier

In earlier paragraphs, it was determined how the pitch and timbre of a sound are synthesized. This final part of the Synthesis Tutorial describes how the volume of sound is controlled. The volume throughout the duration of a sound created by a musical instrument often varies greatly according to the type of instrument.

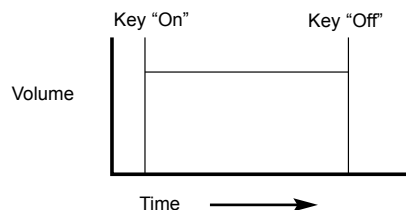

An Organ sound quickly attains full volume when a key on the keyboard is pressed. It stays at full volume until the key is released, at which point the volume level falls instantly to zero.

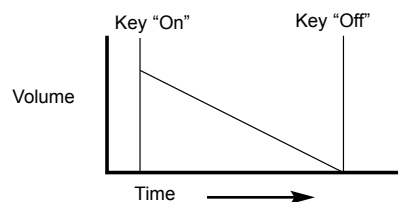

A Piano quickly attains full volume when a key is pressed and gradually falls back down to zero after several seconds, even if a key is held.

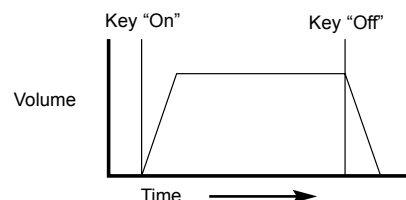

A String Section emulation attains full volume gradually when a key is pressed. It remains at full volume while the key is held down, but once the key is released, the volume level gradually falls to zero.

On an Analogue synthesizer, changes which occur throughout the duration of a note are controlled by a section known as an Envelope Generator. The KS Rack has two Envelope Generators. The circuit of one of these is always connected to an *Amplifier*, which controls the Volume of the sound when a note is played.

Note that there are no controls in a section on the front panel which deal with the Amplifier directly. The only way to hear and control an audio signal passing through the Amplifier is to modulate it by using Amp Envelope controls.

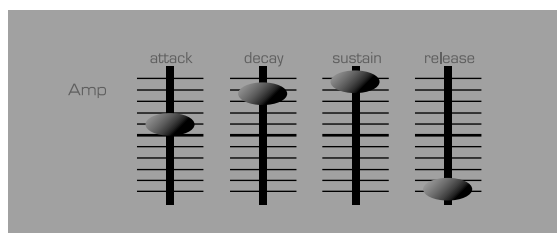

Each envelope generator has four sliders which are used to adjust the shape of the envelope.

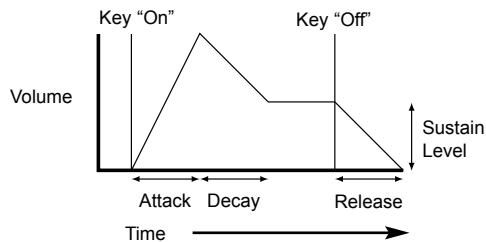

When controlling Volume, these controls adjust the following phases of the Envelope as shown in the illustration.

A = Attack Time

Adjusts the time it takes when a key is pressed for the envelope to climb from zero to full volume. It can be used to create a sound with a slow fade in.

D = Decay Time

Adjusts the time it takes for the envelope to decay from full volume to the level set by the Sustain control while a key is held down.

S = Sustain Level

Sets the volume level that the envelope remains at while the key is held down, after the Decay time has expired.

R = Release Time

Adjusts the time it takes when key is released from the Sustain level to zero. It can be used to create sounds that slowly fade away in volume.

A typical synthesizer will have one or more envelopes. One envelope is always applied to the amplifier to shape the volume of each note played. Additional envelopes can be used to dynamically alter other sections of the synthesizer during the lifetime of each note.

The KS Rack has a second Envelope Generator which may be applied in various interesting ways. For example, it may typically be used to modify the filter cut off frequency or change an oscillators pitch during the lifetime of a note.

LFOs

Like the Envelope Generators, the LFO section on a synthesizer is a *Modulator*. That is to say, instead of forming a part of the sound synthesis process, it is used instead to change (modulate) other synthesizer sections. For example, altering the Oscillator pitch or Filter cutoff frequency.

Most musical instruments produce sounds that vary not just in volume but also in pitch and timbre. Sometimes this variation can be quite subtle, but still contribute greatly towards shaping the final sound.

Where an Envelope is used to control a one-off modulation which occurs during the lifetime of a single note, LFOs modulate by using a cyclic repeating wave pattern. As discussed earlier, Oscillators produce a constant waveform which can take the shape of a repeating sine wave, triangle wave etc. LFOs produce waveforms in a similar way, but at a frequency normally too low to produce an audible pitched vibration that the human ear can perceive. In fact, LFO actually stands for Low Frequency Oscillator.

As with an Envelope, the waveforms generated by the LFOs may be fed to other parts of the synthesizer to create the desired movements in the sound.



There are two independent LFOs available which may be used to modulate different synthesizer sections and run at different speeds.

A typical waveshape for an LFO would be a Triangle wave.

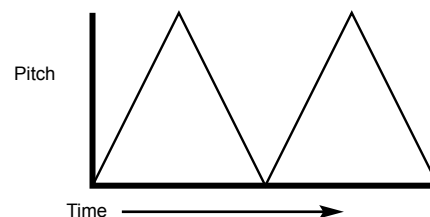

Imagine this slow moving wave being applied to an Oscillator's pitch. The result would be that the pitch of the Oscillator slowly rises and falls above and below its original pitch.

This would simulate, for example, a violinist moving a finger up and down the string of the instrument whilst it is being bowed. This subtle up and down movement of pitch is referred to as the 'Vibrato' effect.

Similarly, if the same LFO were applied to the Filter Cutoff frequency instead of the Oscillator pitch, a similar wobbling effect known as 'wow-wow' would be heard.

As well as LFOs being available to modify (or more commonly known as **Modulate**) different sections of the synthesizer, additional Envelopes may also be used simultaneously.

Clearly, the more Oscillators, Filters, Envelopes and LFOs there are in a Synthesizer, the more powerful it becomes.

Memories - Summary

Memories

The first generation of synthesizers, produced many years ago were large modular machines where each part of the synthesizer was housed in a separate unit (block). These blocks could only be physically connected together by combinations of cables known as patch leads. A typical sound produced by this method would often involve connecting dozens of patch leads.

Every time a new sound was required, the leads would have to be physically disconnected and reconnected. The positions and connections of the leads would have to be noted down on paper if there was to be any hope of creating that particular sound ever again ! If not reconnected in exactly the same way, the sound would be lost forever.

Modern machines such as the KS Rack have all the blocks in one compact unit and the sound generating or modifying blocks are arranged in a sensible fashion. Front panel switches and knobs determine how each block functions and where the sound modifying blocks such as the LFOs and Envelopes are routed, instead of having to physically connect them externally with cables.

Additionally, The settings of these front panel controls (which of course determine the current sound or 'patch') may then be stored in memory locations in the machine which can be recalled at any time.

Summary

An Analogue synthesizer can be broken down into five main sound generating or sound modifying (modulating) blocks.

- 1 Oscillators that generate Waveforms at a certain pitches.
- 2 A Mixer that mixes the outputs from the Oscillators together.
- 3 A Filter that removes certain harmonics, which changes the characteristic or timbre of the sound.
- 4 An Amplifier that is controlled by an Envelope generator. This alters the volume of a sound over time when a note is played.
- 5 LFOs and Envelopes that can be used to modulate any of the above.

Much of the enjoyment to be had with a Synthesizer is with experimenting with the factory preset sounds and creating new ones. There is no substitute for 'hands on' experience. Experiments with altering knobs and switches will eventually lead to a fuller understanding of how the various controls alter and help shape new sounds.

Armed with the knowledge in this chapter, and an understanding of what is actually happening in the machine when tweaks to the knobs and switches are made, the process of creating new and exciting sounds will become easy - Have fun.

It is recommended that this chapter is read carefully if you are unfamiliar with how MIDI works. Experienced users can skip this chapter and move on to the next chapter **Main Features and Operation** on page 18.

About MIDI

MIDI is an acronym for Musical Instrument Digital Interface. The MIDI standard was devised in the early 80's as a means for allowing musical instruments to communicate with each other as well as with other devices such as sequencers and computers. Before the advent of MIDI, it was often very difficult (if not impossible) for instruments to effectively communicate with each other, especially if they had been made by different manufacturers. Nowadays, most types of electronic musical equipment are equipped with a MIDI interface fitted as standard, including synthesizers, drum machines, samplers, sequencers, computers and even some effects units.

The MIDI standard allows many different instruments to be controlled at once (say from a sequencer) using the same network of MIDI cables. Each instrument in the MIDI chain is usually assigned its own unique MIDI channel and will only respond to information that it may receive on that particular channel. The MIDI standard allows for sixteen different channels to be assigned to the various instruments in a MIDI network, which of course means that it is possible to have up to sixteen instruments playing simultaneously within a MIDI system.

Some people may feel that being restricted to just sixteen MIDI channels might be a little limiting, especially if they are composing very complex pieces of music. However, some sequencers and MIDI ports for computers offer a neat way around this problem. They can offer several different MIDI outputs, each of which is treated as a separate MIDI system in its own right with its own set of sixteen MIDI channels.

There are three MIDI sockets fitted at the rear, labeled 'In', 'Out' and 'Thru'. Each one of these sockets has a specific purpose :

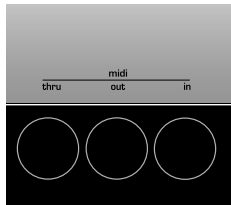

The MIDI IN Port

This is used to receive MIDI information to the KS 4 / KS 5, such as telling it which notes to play from a sequencer for example.

The MIDI OUT Port

This transmits any MIDI information which might be generated by the KS Rack. For example, if a one of the knobs were moved on the front panel.

The MIDI THRU Port

This simply re-transmits any MIDI information that has been received at the MIDI In socket. This socket is useful for connecting other instruments into the same MIDI network. By connecting a cable from the MIDI Thru to another instrument's MIDI In socket, both the KS 4 / KS 5 and the second instrument could be controlled simultaneously from a sequencer.

As seen in the diagram, if desired, the process can be repeated; a third instrument could be added to the same MIDI network, simply by connecting a cable from the second instrument's MIDI Thru to the third instrument's MIDI In, and so on.

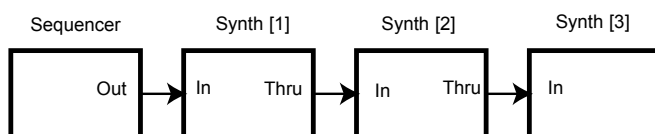

'Chain' method of connecting three MIDI devices to a sequencer

Some non-Novation instruments may not have a MIDI Thru socket fitted. In these cases, the instrument should be placed at the end of the MIDI chain or a Thru box should be incorporated into the MIDI system.

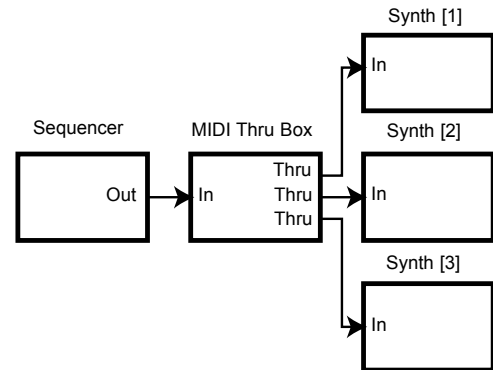

'Star' method of connecting three MIDI devices to a sequencer

A Thru Box simply provides a number of identical MIDI Thru sockets from a single MIDI In.

It is important to realise that MIDI information *flows in one direction only along the cable*. It is not possible to have a MIDI In socket connected to another MIDI In socket for example. If this were done, the MIDI network would simply not work ! In fact, the only routings allowed are MIDI Out to MIDI In or MIDI Thru to MIDI In.

Some devices known as controllers are equipped with only a single MIDI Out socket and are used exclusively to generate MIDI data for controlling other instruments. Examples of common MIDI controllers are controller keyboards (these are simply keyboards with no synthesizer attached), drum percussion pads or footswitch controllers.

MIDI messages

The KS Rack is capable of transmitting and responding to various types of MIDI events. These are as follows :

NOTE MESSAGES

A note message is transmitted every time a key on a keyboard is pressed down or released. When a keyboard note is pressed down, the MIDI message also includes velocity information. The velocity value in the MIDI message represents how hard the key was pressed down. This velocity value can be used to add dynamics to the sound, depending on how hard the note was played.

CONTROL CHANGE MESSAGES

These messages are transmitted whenever one of the knobs or sliders are moved on the front panel. Most parameters within a menu will also transmit MIDI control change messages when the parameter is altered with the DATA knob. The MIDI specification allows for 128 different types of controller message. These are often referred to as Continuous Controllers (CC0 to CC127).

Some controllers are rigidly defined by the MIDI standard for specific purposes. For example, CC1 is always used for the modulation wheel.

Whenever the modulation wheel is moved, it will transmit MIDI control change information using CC1. All other makes of synthesizers will also use CC1 for modulation wheel data.

Certain other control change numbers have no set purpose within the MIDI specification. For example, whenever the Filter FREQUENCY knob is moved, it will transmit using CC105. There is no guarantee however that other makes of synthesizer will use this control change number for the same purpose.

MIDI messages

There are more than 128 different parameters that can be transmitted by MIDI, but because the number of different types of control change message is limited to just 128, a more complicated arrangement had to be employed for additional parameters.

This method uses what is known as NRPNs. (NRPN stands for Non Registered Parameter Number). NRPNs consist of three MIDI control change messages grouped together, rather than a single MIDI control change message which is used normally.

PITCH BEND MESSAGES

These messages are transmitted whenever the pitch bend wheel is moved on a Master keyboard.

AFTERTOUCH MESSAGES

These messages are transmitted by some keyboards whenever already-held down keyboard notes are pressed further. Aftertouch messages can be used to add extra expressiveness to a sound, for example introducing an extra vibrato effect.

The MIDI specification defines two different types of aftertouch message; mono and poly. The type recognised by the KS Rack is mono. Poly aftertouch includes information in the MIDI message about which keyboard note was used to trigger the aftertouch effect. Poly aftertouch is very rarely used and only a very few synthesizers ever implemented the system.

PROGRAM CHANGE MESSAGES

These messages are transmitted whenever a new sound is selected from the front panel. The MIDI Specification allows a MIDI program change message to select one of 128 different sounds. When the MIDI specification was originally designed, this was not a problem since synthesizers in rarely had more than 128 memories.

Modern synthesizers such as the KS Rack offer many more memories, so it is necessary to send a MIDI program change preceded by an additional MIDI message which specifies which 'bank' of sounds the program change message will select from.

The bank select MIDI message used for this purpose is a MIDI control change message (CC32 is the control change number used). Whenever a new sound is selected, the bank select MIDI message is transmitted, followed closely by the appropriate MIDI program change message.

If these messages are then layed back to the KS 4 / KS 5 from a sequencer, the appropriate sound will be selected.

It is not necessary to send a bank select message before the program change message (though recommended). It is permitted to omit the bank select, but if so, the program change message will select the sound from whatever bank of sounds is currently selected.

Channel Messages

All of these different types of MIDI message detailed above include information detailing which MIDI channel was used when the message was transmitted. MIDI channel messages only affect receiving devices using the same MIDI channel. For example, a pitch bend message sent using MIDI channel 1 would have no effect if it were received on a synthesizer set to respond on MIDI channel 2.

Some MIDI messages do not include any MIDI channel information defined in them. Some examples of these are :

MIDI CLOCK MESSAGES

These are synchronization messages sent from a sequencer. When received, they enable tempo-locked features such as the arpeggiator and various effects parameters (such as Panning and Delay sync) to follow the current tempo of the sequencer.

The KS Rack itself does not transmit MIDI clock messages, so it can only be synchronized to follow the tempo of other devices and not vice versa.

Whenever an external sequencer is started, a Start Song MIDI message is usually transmitted. Certain features can be set to reset their synchronisation when a Start Song message is received.

SYSTEM EXCLUSIVE MESSAGES

This is special type of MIDI message which can contain any type of data, depending what the synthesizer manufacturer decides to put in it! The only constraint with system exclusive messages is that they always contain certain header information which is exclusively used by the manufacturer (and usually the relevant synth model as well).

This means that a KS Rack will only accept a system exclusive message designed especially for it. If it receives a system exclusive message transmitted by a different make of synthesizer, the message would simply be ignored. Similarly, other makes of synthesizer will ignore any system exclusive messages originally sent by a KS Rack.

System exclusive messages have employed for two distinct purposes. They can be used to back up all of the Program, Drum Map and Performance memories and global data. This feature is extremely useful in building up a sound library on a computer or for making a safety copy of data in case the worst should happen.

Data backup is discussed in detail on Page 49 in the **Advanced Features** chapter.

System exclusive messages also enable an entire new operating system to be received via MIDI. The latest operating system is always available free of charge at the Novation web site. From there, it can be downloaded as an SMF (Standard MIDI File).

Because the operating system update consists purely of MIDI system exclusive messages, it can then be transferred by playing the file on a sequencer directly into the machine. However, as a safety feature, the KS Rack must be set to a special mode where it is able to accept an operating system update. Full details on how to do this are supplied along with the downloaded OS update.

For a list of the latest operating system updates, please visit the Novation website :

<http://www.novationmusic.com>

A MIDI Implementation Chart provides a concise way of telling at a glance which MIDI messages an instrument will transmit and respond to. A MIDI Implementation Chart for the KS Rack can be found on page 57. How it transmits and responds to MIDI in the different playing modes is also described in detail on page 56.

MIDI and Sequencers

A sequencer is simply a device which is capable of recording, storing and playing back MIDI information. Using a sequencer, it is possible to construct very complex musical arrangements which would normally be impossible to play 'live'. It is also very easy to edit the MIDI data and remove any unintended mistakes or make changes in the playing style. Many people nowadays use software sequencing packages on computers, but there are also dedicated hardware sequencers available which perform in a similar way.

All sequencers can record MIDI information exactly as played on a synthesizer's or master keyboard. To do this, simply make sure the MIDI Out is connected to the sequencer's MIDI In and start the sequencer recording. Any keys played on the keyboard or wheel movements made will be faithfully recorded. Similarly, it is also possible to record the MIDI information generated by adjusting the KS Rack's controls by connecting the KS Rack MIDI Out to the sequencer's MIDI In. This is known as 'real time' recording. As long as the sequencer's MIDI Out is connected to the KS Rack's MIDI In, this MIDI information can then be played back into the KS Rack, exactly reproducing all the actions made and notes played while recording the sequence.

On most sequencers, it is also possible to enter new MIDI events in 'step time' by explicitly defining each MIDI event without having to supply the relevant MIDI data to the sequencer's MIDI In socket. Obviously, some knowledge of MIDI is needed in order to do this.

Nearly all sequencers offer multiple recording tracks. These tracks behave in a similar fashion to multi-track tape recorders, except that instead of holding audio recordings, they hold their own record of MIDI data. Usually, each sequencer track will contain MIDI data associated with a distinct MIDI channel. By using sequencer tracks in this way, it would typically be possible to build up a complex song arrangement with one track being used to control the drums, another the bass line, another the lead sound and so on. On the KS Rack, different sequencer tracks can be used to play each of the four Performance Parts simultaneously.

When using a sequencer, some careful thought should be given as to the way the MIDI information is routed through the sequencer. With most sequencers, any MIDI information that appears at the sequencer's MIDI In socket is immediately re-transmitted again from the sequencer's MIDI Out socket. If desired, it is sometimes possible to turn this feature off. It usually called 'echo back' or 'soft thru'. Consult your sequencer manual for details.

It is very important to realise that if 'soft thru' is enabled on a sequencer, the MIDI information re-transmitted by the MIDI Out socket is always converted to the MIDI channel used by the currently selected sequencer track. This means that if a track is selected on a sequencer which uses MIDI channel 2, and the sequencer then receives some MIDI information from a KS Rack sent on MIDI channel 1, *it will be re-transmitted by the sequencer not on MIDI channel 1, but MIDI channel 2*. This would be quite useful for programming knob movements into the sequencer for other MIDI devices or Parts, but can lead to some quite unexpected results if careful note is not kept of exactly what is happening !

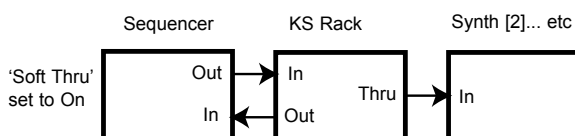

Typical example of using the KS Rack to control other devices in a MIDI system

Because many sequencers re-channelise MIDI information in this way, it is quite possible to use the KS Rack to supply MIDI information to control other Parts in a Performance or other external MIDI equipment such as a sampler.

In **Performance Mode**, each of the four Parts can be played simultaneously with each Part responding on its own unique MIDI channel. To reflect this, four tracks should be configured on the sequencer with each track's MIDI channel setting reflecting the channel used on each of the

four KS Rack Parts. When the KS Rack is being used multi-timbrally in this manner, when recording MIDI data from the KS Rack, make it a rule-of-thumb to *always select the appropriate sequencer track before selecting the Part on the KS Rack's front panel*.

When controlling external MIDI equipment (in this example a KS 5), the sequencer track must be selected which corresponds to the same MIDI channel that the sampler is using. However, it would be noticed that as soon as knob movements are played into the sequencer from the KS Rack, the KS Rack would be affected as well as the KS 5. To overcome this problem, there is a feature available called **Local Control**.

Local Control

Local Control is a parameter found in the Global Menu (see page 50 for details) which in effect, disconnects KS Rack panel controls from the synthesizer engine.

When the front panel controls are moved, they still transmit the usual MIDI information *but they have no direct control of the internal sound engine*. When **Local Control** is set to **OFF**, the only way that controls can be used to affect the sound engine is when the MIDI information sent from the KS Rack is routed through the sequencer (with the correct sequencer track selected), back to the MIDI In socket.

When not connected correctly to a sequencer, having **Local Control** set to **OFF** is a common cause of mistakenly assuming that the machine is faulty. When the KS Rack appears to ignore its front panel controls, setting **Local Control** to **ON** or selecting the correct sequencer track will usually rectify the 'problem'.

See page 50 for altering the Local Control setting.

Summary

MIDI information is transmitted whenever a master keyboard is played, or when front panel controls are moved or a new Program is selected on the KS Rack.

MIDI information is split into 16 channels. The KS Rack's can be set to receive / transmit on any one of these channels at any one time in Program Mode. When used in Performance Mode, up to four Parts can be individually set to receive on different MIDI channels.

MIDI information travels in one direction along a MIDI cable. The only permitted connections are MIDI Out to MIDI In, or MIDI Thru to MIDI In.

MIDI messages can be recorded into a sequencer and later replayed back into the KS Rack, replicating whatever actions occurred when the MIDI messages were originally transmitted.

Sequencers usually re-transmit any MIDI information they receive immediately, converting the message's channel information into whatever MIDI channel the currently selected sequencer track is using.

Because of this, the KS Rack's knob movements or arpeggiator output may be used to control other MIDI devices in a MIDI network.

An option called **Local Control** disables the front panel controls from the synthesizer engine. When set to **OFF**, moving the front panel controls only results in MIDI information being transmitted.

Setting **Local Control** to **OFF** allows the KS Rack to control other MIDI instruments without altering settings on the KS Rack directly.

Front Panel Layout

Front Panel Layout

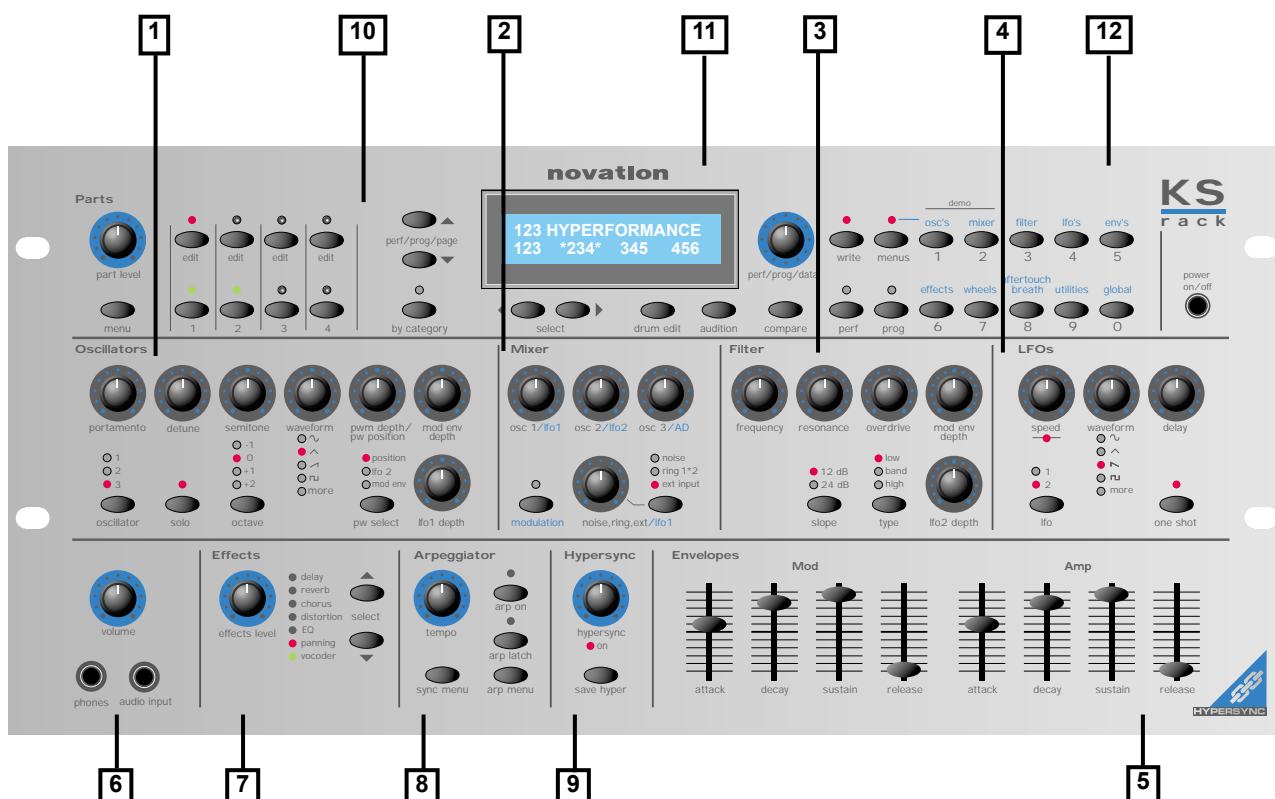

1 - Oscillator Section

Contains the controls associated with the Oscillators. These include the PORTAMENTO, WAVEFORM, SEMITONE tune, DETUNE, PWM DEPTH / PW POSITION, MOD ENV DEPTH and LFO 1 DEPTH knobs and the OSCILLATOR select, SOLO, OCTAVE and PW SELECT buttons.

2 - Mixer Section

Contains the controls associated with the Mixer. These include the OSC 1 / LFO 1, OSC 2 / LFO2, OSC 3 / AD and NOISE / RING / EXT / LFO 1 knobs and the MODULATION and NOISE / RING / EXT buttons.

3 - Filter Section

Contains the controls associated with the Filter. These include the FREQUENCY, RESONANCE, OVERDRIVE, MOD ENV DEPTH and LFO 2 DEPTH knobs and the SLOPE and TYPE buttons.

4 - LFO Section

Contains the controls associated with the two LFOs. These include the SPEED, WAVEFORM and DELAY knobs and the LFO and ONE SHOT buttons.

5 - Envelopes Section

Contains controls associated with the two Envelopes. These are two sets of ATTACK, DECAY, SUSTAIN and RELEASE controls. Knobs are used for the MOD Envelope and Sliders are used for the AMP Envelope.

6 - Master Volume, Headphones and Audio Input Jacks

7 - Effects Section

Contains controls associated with the Effects. These include the EFFECTS LEVEL knob and SELECT buttons.

8 - Arpeggiator Section

Contains controls associated with the Arpeggiator. These include TEMPO knob and the ARP ON, ARP LATCH and ARP MENU buttons.

9 - Hypersync Section

Contains controls associated with the Hypersync feature. These include the HYPERSYNC knob and the SAVE HYPER and SYNC MENU buttons.

10 - Part Section

Contains controls associated with editing and selecting Parts. These include the PART LEVEL knob, the four Part EDIT buttons, the four Part Activate buttons and the Part MENU button.

11 - Display and Data Entry Section

Contains the display, the PERF / PROG / DATA knob and the PERF / PROG / PAGE, BY CATEGORY, SELECT, DRUM EDIT, AUDITION and COMPARE buttons.

12 - Mode and Keypad Section

Contains the WRITE, MENUS, PERF, PROG buttons and the numeric keypad / Menu select buttons.

Modes and Menus

As described in the **Quick Start Guide**, in Program Mode, the machine operates in a mono-timbral (just one sound available) mode and responds to, and sends information on just one MIDI channel. This mode should be used when only one sound is required for playing, or when individual sounds are to be auditioned.

In Performance Mode, additional information is added to each sound (Program) such as MIDI channel and note range and this complete set of information is stored in what is known as a Part. Up to four of these Parts can then be used simultaneously in a Performance.

The LEDs located above the PROG and PERF buttons indicate which playing mode is selected.

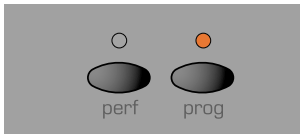

Program and Performance Modes

This mode enables a new single Program (sound) to be selected from the front panel controls. Program Mode is selected by pressing the PROG button. Selecting Program Mode cancels Performance mode.

```
Program's name  101
```

In Program Mode, the display will show the currently selected Program's name and number. Performance Mode is selected by pressing the PERF button. Performance Mode is cancelled when Program mode is selected.

```
Performance name 101
123 234 345 456
```

In Performance Mode, the display shows the selected Performance's name and number on the top line of the display. The four sets of numbers on the bottom line are the Program number references that are assigned to each of the four Parts.

If the cursor is located at the Performance number, a new Performance can be selected by using either the data knob, up/down buttons or the keypad.

```
Performance name 101
123 234 345 456
```

Moving the cursor to any of the Part numbers allows a new Program or Drum Map to be selected for a Part.

The cursor is moved using the SELECT left and right buttons.

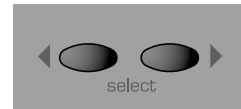

Pressing the SELECT LEFT button will position the cursor at the first program at the bottom left of the display. Pressing the SELECT RIGHT button will position the cursor at the fourth program at the bottom right of the display. Subsequent presses of either button will move the cursor one step left or right to select the next Program.

Once the cursor is positioned over a Program number it is possible to select a new Program to be used in the Performance by any of the methods described in the following text. To return to selecting a new Performance the PERF button must be pressed.

A new Program or Performance may be selected by one of three methods.

i) The PERF / PROG / DATA knob may be used. Turning the knob quickly increases the intervals jumped between Programs / Performances.

When selecting Programs, the BY CATEGORY button may be used to search only for Programs within a specific category.

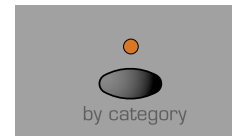

When pressed, the LED above the BY CATEGORY button lights to indicate that category searching is active. The display shows the category assigned to the currently selected Program.

```
Program's name  101
Bass
```

It is possible to select a different category for searching by using the SELECT left and right buttons.

While category searching is active, the PERF / PROG / DATA knob will only select Programs saved with the currently selected category.

To cancel category searching, press the BY CATEGORY button again (the BY CATEGORY LED goes out) or the PROG or PERF buttons.

Note : Category searching is only available for selecting Programs. It cannot be used to select Performances.

ii) The PERF / PROG / PAGE buttons may also be used to step forwards or backwards from the currently selected Program or Performance. If a PERF / PROG / PAGE button is held down, the Programs or Performances will jump in intervals of ten.

iii) Programs or Performances may also be selected by typing a three digit sequence on the numeric buttons. The Program or Performance will not actually be selected until the third digit has been entered.

Note that Program Mode does not have to be selected in order to select a new Program via MIDI (from a sequencer for example) nor in Performance Mode in order to select a new Performance via MIDI.

A new Program or Performance may be selected via MIDI at any time in any mode. At this time, the relevant playing mode is also selected..

Modes and Menus

Making an Edit with the front panel Controls in Program Mode

If any of the front panel controls are adjusted, the display will show the new value of the appropriate control.

If for example, the Filter FREQUENCY knob was adjusted to 100, the display would show :

```
Filter frequency 127
                90
```

The number on the bottom line is the current value of the Filter Frequency. This is the value that is stored in the Program *before* any tweaks or edits have taken place.

The number at the top right is the new edited or tweaked value. This feature make is very easy to see how any control or switch was set in the original program.

'Pinging' to new Values

Suppose the Filter FREQUENCY knob is fully clockwise (physically pointing to the 5 o'clock position) indicating a fully open setting (127).

If the Filter setting of the Program being listened to is actually set to the 2 o'clock position (say 101), a slight movement of the FREQUENCY knob will result in the sound 'pinging' instantly to a brighter sound. This is because the Filter frequency will jump to a maximum value of 127 represented by the knob's current physical 5 o'clock position.

The number appearing on the bottom line makes it easy to 'home in' on the original value stored with the Program or Performance.

Making an Edit with the front panel Controls in Performance Mode

Performance Mode is selected by pressing the PERF button. The LED above the PERF button lights to confirm selection. The standard Performance Mode screen is displayed.

```
Performance name 101
123 234 345 456
```

The cursor is positioned at the Performance number adjacent to the Performance's name. (Performances are numbered 100 to 199). At this position, selection of Performances is achieved in a similar manner to selecting Programs by means of the Keypad buttons, the PAGE buttons, or the DATA knob.

The BY CATEGORY button cannot be used to select Performances.

The four sets of numbers beneath the Performance name refer to the Program numbers that are held in each of the parts within the Performance. The illustration below shows the relationship between Performances, Parts and Programs.

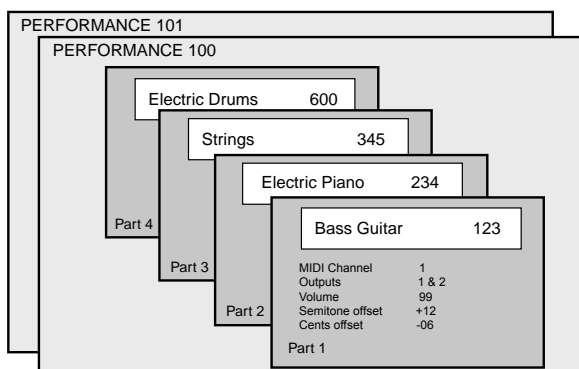

Held in the Performance are 4 part 'slots' that may in turn hold any one of 400 single Programs. For versatility, other information such as MIDI channel, note range etc. is also held in each part along with the program number.

This additional information may be edited by pressing the Menu button under the part level knob - See page 54 for more information on these parameters.

The SELECT left and right buttons are use to select the Part (where the Program is held) for editing.

Press the SELECT left button. The cursor will move to the Program number held in Part 1 of the Performance. Subsequent presses of the SELECT left and right buttons will move to the next Program number across the bottom line of the display.

```
Performance name 101
123 234 345 456
```

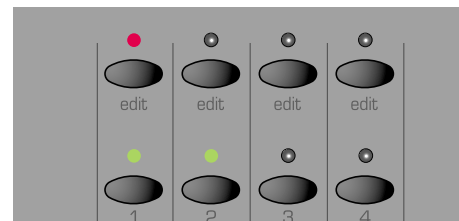

The program number underlined is reflected on the front panel by the red LED being lit. Moving the cursor with the SELECT buttons will also cause the red LED to move in sympathy. Similarly, pressing a different edit button in the parts section will cause the cursor to move.

At this time, the KEYPAD buttons, PAGE up / down buttons and DATA knob may be used to select a new Program number on the selected Part

The BY CATEGORY button may be used to select a Program in the same way as previously described. To return to selecting a Performance, press the PERF button.

Any control that is moved moved on the front panel is now editing the program that is held in the part of the currently selected performance.

The display will behave in the same way as when editing a single program - See above left.

NOTE: Edits made to Programs that are held in a performance DO NOT affect the programs that are held in the single program memory areas 100 - 399. There is a complete additional copy of the program held in the part of the performance.

This powerful feature allows changes to be made to sounds within a performance without having to worry that, if the program is used elsewhere it will be affected.

If, for example the program on part 1 was edited, the display would look similar to the following illustration

```
Performance name*101
*123 234 345 456
```

An asterisk will appear to inform that *this* program held in *this* performance is different in some way to the program in the single program area numbered 123. Also notice that a further asterisk appears next to the performance number indicating that, it too has changed from the original.

MAIN FEATURES AND OPERATION

Modes and Menus

Exporting the edited program out of the performance

Pressing the write button when the cursor is under the program number will just save the program number to a desired location. The saving procedure is detailed on page 8 of the quick start guide section.

This provides a convenient method to EXPORT edited programs out of a performance back to a single program memory location.

Saving the edited performance

Press the PERF button and the cursor will position itself under the performance number. Press the write button to initiate the saving of the performance. See Page 8.

After saving the performance, the display would appear as below.

```
Performance name 101
*123 234 345 456
```

Notice that the asterisk has disappeared from the Performance number since both the saved performance and the one being listened to are the same. Also notice that the asterisk before the program number 123 is still visible since the program held is this performance is different in some way to that held in the single program memory area.

It is possible to make the editing displays permanent (for example when the Filter knob is adjusted the values will stay on the display permanently until another control is used). It is also possible to vary the time that the displays are shown for. These options are in the Global Menu. See page 51 in the **Advanced Features** chapter for more details.

Menus

Many of the advanced features and utilities are available from menus. There are thirteen separate menus, each of which consists of several pages linked together. Menu pages are accessed by pressing any of the relevant MENU button.

When any of the MENUS are activated the LED situated above the MENU button is lit. As soon as a Menu is entered, the display will show the first page of whichever menu was accessed the previous time the Menu was used.

For example, if the Filter Menu had been previously selected, the display would show one of the pages of the Filter Menu.

```
Filter Q norm 13
<<MENU>> 49
```

Once any of the Menus have been selected, the PERF / PROG / PAGE buttons to the left of the display are used to navigate forwards and backwards between the menu's pages. Once the desired menu page has been reached, the values are altered by using the PERF / PROG / DATA knob.

The display behaves in the same way as when a front panel control is adjusted. The current value being shown on the bottom line and the new value being shown on the top line. MENU text in capitals is at the left of the display to inform that a MENU is selected.

When the Main Menu button is selected, as in the following illustration, different menu may be activated by pressing any of the 0 - 9 keypad buttons.

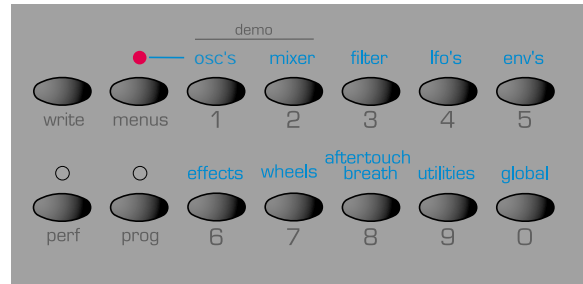

The ten menus available here are associated with the Oscillators, Mixer, Filter, LFOs, Envelopes, Effects, Wheels, Aftertouch / Breath Control, Utilities and the Global parameters.

The Part, Sync and Arpeggiator menus are always selected directly by pressing the dedicated menu buttons within the appropriate section on the front panel.

When any menu is selected, the page that first appears may be set using one of the options in the Global Menu. See page 51 for information on how to do this.

Once in a Menu it is possible to alter any of the front panel controls as in Program Mode, but it will be noticed that when a knob is moved, the display text for the knob just moved will only be shown on the screen for a short period of time. (This time is set using the **Function Display time** parameter in the Global Menu - see page 51). After a short time, the display will revert back to showing the current menu page.

It is possible to exit a Menu by pressing the current Menu button again, or to move to another menu by pressing a different menu button.

If Program Mode was selected before pressing a menu button, then Program mode will be selected on exit.

If Performance Mode was selected before pressing a menu button, then Performance Mode will be selected.

It is possible to exit any menus by pressing the PROG or PERF buttons.

Oscillator Section

Oscillator Section

The Oscillators generate pitched waveforms (as described in the **Synthesis Tutorial** chapter) and these are fed into the Mixer. Most of the controls which determine the pitch and waveform of the Oscillators, and how they react to modulation are in this area of the front panel.

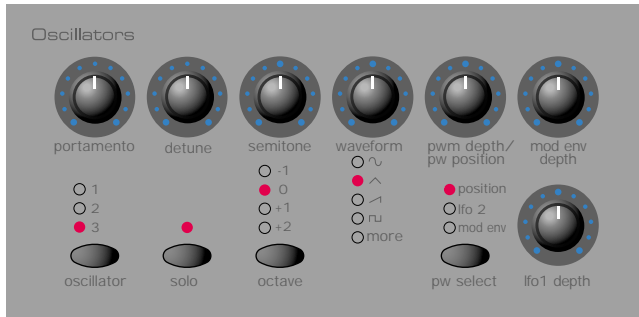

OSCILLATOR Select Button

There are three independent Oscillators. Each one can be independently controlled by the buttons and knobs in the Oscillator area. To make make the controls active and to see waveform and octave settings for Oscillator 1, press the OSCILLATOR button once or more until LED 1 lights. For Oscillator 2, press until LED 2 lights and for Oscillator 3 press until LED 3 lights.

SOLO Button

While this button's LED is lit, only the currently selected Oscillator can be heard. The other two Oscillators are muted. This feature is useful for auditioning Oscillators individually while creating complex sounds. Press the SOLO button again to resume normal operation.

Note that this button's status is not stored when a Program is saved.

OCTAVE Button

Sets the basic pitch of Oscillator 1, 2 or 3 in Octave jumps. To change the basic pitch of the selected Oscillator to +1 octave for example, repeatedly press the OCTAVE button until the +1 LED lights.

NOTE: The 0 position corresponds to the pitch of 440Hz when note A above middle C is played.

PW SELECT Button and PWM DEPTH / PW POSITION Knob

The function of the PWM DEPTH / PW POSITION knob is dependent on the selection of the PW SELECT button. With the POSITION setting selected, the PWM DEPTH / PW POSITION knob will manually control the pulse width of a square waveform (the selected waveform for the Oscillator must be Square wave for this to happen). In order to understand how the Pulse Width knob affects various waveforms, examples, using factory presets are used. See the following paragraphs titled:

Obtaining a classic Square/Pulse PWM sound and Obtaining a Double Saw 'thick' detuned sound.

With the PW POSITION knob in the central position, the Pulse Width wave becomes a square wave. As the knob is adjusted clockwise, or anti-clockwise, the Pulse Width becomes narrower producing what is termed as a Pulse Wave.

With the LFO 2 position selected by the PW SELECT button, the width of the Pulse Wave may be modulated by LFO 2. The intensity of this modulation is determined by the PWM DEPTH knob. With the Pulse Width knob at central position there is no effect. Turning clockwise or anti-clockwise introduces the effect. Continuous variation in the width of a pulse waveform (which is what is happening when LFO 2 is modulating it) changes the harmonic content. This is pleasing to the ear, especially at lower pitches where all the associated harmonics fall within the audio range. This creates the classic PWM sound, as described below.

When modulated by the MOD ENV, the effect is most apparent when using fairly long Mod Env Attack and Decay times.

Obtaining a classic Square / PWM sound

The PWM sound is one of the classic analogue synthesizer sounds. Select one of the factory initialisation sounds (311 - 499). All of these initial sounds use only use Oscillator 1 as the source waveform. Select a square waveform using the WAVEFORM button in the Oscillators section. Notice how the timbre changes to a more 'woody' sound. Select POSITION using the PW SELECT button.

Rotate the PWM DEPTH / PW POSITION knob and notice how the sound changes to a very thin nasal sound when the knob is towards the clockwise or anticlockwise end stop positions. (In fact the sound will extinguish completely at maximum settings). Leave the knob at the 12 o'clock position.

Select LFO 2 using the PW SELECT button. Slowly rotate the PWM DEPTH / PW POSITION knob. Notice that there will now be some movement in the sound. Select LFO 2 in the LFO's section using the LFO button. Rotate the SPEED knob in this section and notice how the speed of the movement will change. Experiment with the above controls until the desired sound is achieved.

Obtaining a Double Saw 'thick' detuned sound

A thick 'Double Saw' detuned sound using just a single Oscillator may be created easily. If necessary, this sound can be stacked using additional Oscillators to produce a 'huge' sound. Select one of the factory initialisation sounds (311 - 499). All of these initial sounds use only use Oscillator 1 set to a sawtooth as the source waveform. Select POSITION using the PW SELECT button.

Rotate the PWM DEPTH / PW POSITION knob fully clockwise. As the control is rotated, a double sawtooth wave is generated. At this fully clockwise position the pitch will appear to double.

Select LFO 2 using the PW SELECT button. Slowly rotate the PWM DEPTH / PW POSITION knob. Notice that there will be some movement in the sound. Select a sawtooth LFO wave using the WAVEFORM button in the LFOs section. Press the LFO button to select LFO 2. Rotate the SPEED knob in this section and notice how the speed of the movement will change. Experiment with the above controls until the desired sound is achieved.

PORTAMENTO Knob

This knob adjusts the Portamento effect. With this control set to zero, when the keyboard is played, the pitches of notes change instantly from one pitch to another as different keyboard notes are played. Turning the knob clockwise introduces the Portamento effect. Notes will glide smoothly from one pitch to the next. Increasing the amount will slow the time taken for the pitch of the first note to reach that of the second note played.

WAVEFORM Knob

This knob sets the currently selected Oscillator's waveform. As the knob is turned, the WAVEFORM LEDs indicate which waveform is currently selected. There are 32 waveforms available. The first 4 of these are the traditional waveform shapes found on classic analogue synthesizers. The next 4 are special noise types. The remaining 24 are digitally sampled waveforms that provide useful sources for emulating more traditional instruments and percussion sounds.

When this knob is at the fully anti-clockwise position, the Sine waveform is selected. As the knob is turned clockwise, the other traditional waveforms are selected. After these, the more complex harmonic waveforms are available. Whenever one of these is selected, the MORE LED will be lit on the front panel.

On the following page is a table of all the Oscillator waveforms available.

Oscillator Waveforms	
No.	Description
0	Sine
1	Tri-Angle
2	Sawtooth
3	Square (Pulse)
4	White Noise
5	Hi-Pass Noise
6	Band Pass Noise
7	Hi / Band Pass Noise
8	Organ
9	Harpiscord
10	Electric Piano
11	Slap Bass
12	Rhodes Piano
13	Rhodes Tine
14	Whirly EP
15	Clavinet
16	Analogue Bass
Rhythm Sounds	
17	Kick 1
18	Kick 2
19	Kick 3
20	Snare 1
21	Snare 2
22	Snare 3
23	Tom Tom (Front)
24	Rimshot
25	Stick
26	Closed Hi-Hat
27	Open Hi-Hat
28	Tamborine
29	Conga
30	Cow Bell
31	Cymbal

SEMITONE Knob

Raises or lowers the selected Oscillator's pitch in semitone increments up to a full octave. Setting the pitch of Oscillator 1 to zero and adjusting the pitch of Oscillator 2 and 3 by differing amounts results in some musically pleasing intervals. Settings 5 (a perfect 4th), 7 (a perfect 5th), 3 (minor 3rd), 4 (major 3rd), 8 (minor 6th) and 9 (major 6th) offer the best results. Use other settings for intentionally discordant sounds.

DETUNE Knob

Sets the detune amount in Cents for the selected Oscillator 1,2 or 3. If it is set fully clockwise, the Oscillator's pitch will be 50 cents sharper than its basic pitch. Fully anticlockwise and it will be 50 cents flat.

Slight detuning between each Oscillator will enrich the sound by introducing a beating between the Oscillators (in the same way a 12-string guitar sounds richer than a 6-string). Bass and lead sounds can be fattened up using a small amount of detune. Large amounts of detuning will lead to more extreme effects.

MOD ENV DEPTH Knob

Controls the amount of pitch modulation to the currently selected Oscillator from the Mod Envelope. In the centre position there is no effect on the oscillator's pitch. Anticlockwise the effect is negative (i.e. the pitch drops and then rises) and clockwise, positive (the pitch rises and then falls).

See **Envelopes Section**, on Page 26 for the setting of the rise and fall times.

LFO 1 DEPTH Knob

Controls the amount of pitch modulation to an Oscillator from LFO 1. It controls how much above and below the basic pitch the Oscillator regularly rises and falls. If the LFO 1 is set to a Triangle wave and the LFO's speed knob is above the centre of its range, this will produce a vibrato effect. Other effects like a siren or sea gull cry are possible with more extreme settings.

Other functions associated with the Oscillators can be found in the Oscillators Menu. See Page 34.

Mixer Section

The Mixer makes it possible to combine the outputs of Oscillators 1,2 and 3, the Noise source, the Ring modulator and the external Audio Input. The ability to mix together any or all of these sound sources makes it easy to create complex timbres.



OSC 1, OSC 2 & OSC 3 Knobs

Normally controls the volumes of the three Oscillators. Fully anticlockwise results in no signal. In this position and with all the other Mixer levels turned down, there will be no audio output. Fully clockwise results in full volume for the appropriate Oscillator.

When the MODULATION LED is lit (see below) these knobs control the amount of modulation applied to the mixer. In the central position, no modulation is applied. Turning the knobs clockwise introduces positive modulation (the mixer levels become louder). Turning the knobs anticlockwise introduces negative modulation (the mixer levels become quieter).

MODULATION Button

This determines how the various knobs in the Mixer Section are used. When this button is pressed, the LED above the MODULATION button is lit and each of the Mixer Section knobs control the amount of modulation applied from the source specified by the knob. The level of Oscillator 1 is modulated by LFO 1. The level of Oscillator 2 by LFO 2, the level of Oscillator 3 by the AD Envelope (see page 39 for setting the AD Envelope parameters) and the level of the Noise / Ring Modulator / External input also by LFO 1. These modulation assignments are fixed and cannot be redefined.

Note : The AD Envelope is a special, dedicated Envelope used for FM synthesis or to control the level of OSC 3 in the Mixer. It should not be confused with the AMP or MOD Envelopes found on the KS 4 / KS 5 front panel.

When the MODULATION button LED is not lit, the Mixer section knobs control the levels of the various signals fed through the Mixer.

NOISE / RING / EXT Button and Knob

The NOISE / RING / EXT button selects which sound source the NOISE / RING / EXT knob will control.

With the NOISE position selected, it controls volume of the White Noise Generator. White Noise is useful for creating sound effects such as Wind.

With the RING 1 * 2 position selected, it controls the volume of the Ring Modulator. Ring Modulation is useful for creating harder Metallic tones.

With the EXT position selected, it controls the volume of an external audio signal connected to the INPUT socket on the KS Rack's rear panel. This signal can be processed by the filter, envelopes and effects. An external audio signal may be a microphone, CD player, guitar etc. With a little experimentation, quite effective and dramatic changes to the sound can be produced : Filtering, wah-wah, gating, using the Effects Section for adding reverb, chorus etc. Experiment !

Note: All three of these sound sources may be used simultaneously and if so, it may become necessary to reduce the **Program Level dB** in order to avoid signal distortion (see page 39).

Filter Section

Filter Section

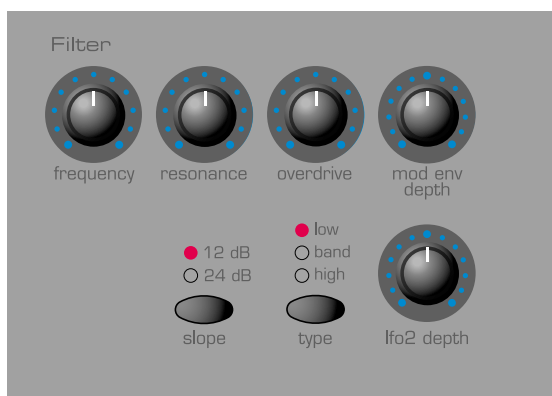

The Filter can be used as a Low Pass, High Pass or Band Pass type.

FREQUENCY Knob

This controls the basic Cut off frequency of the Filter. The Low Pass type of Filter is the most common type of Filter found on classic analogue synthesizers and is musically the most useful, especially for bass sounds. As the FREQUENCY knob is adjusted anticlockwise, harmonics are gradually removed from the sound. When almost closed, only the fundamental frequency remains. Fully closed and no sound at all passes.

With the High Pass Filter type, as the FREQUENCY knob is adjusted clockwise, harmonics are gradually removed from the sound. When almost fully anticlockwise, only the fundamental frequency remains. When Fully clockwise and no sound at all passes.

With the Band Pass Filter type, a narrow band of frequencies are passed, centered on the position of the FREQUENCY knob. This kind of Filter is useful when it is desired to pass only a specific frequency present in a sound.

RESONANCE Knob

This knob controls the Resonance of the Filter. The control will boost frequencies at the Cut off frequency. On some synthesizers, this control is known as Emphasis since it will emphasize certain frequencies. At the zero position there is no effect. Turning clockwise slowly introduces the emphasis.

Set fully clockwise, the Filter will begin to self - oscillate, producing a new pitched element (similar to feedback on an electric guitar).

Note : At least a small signal must be fed into the Filter in order for the resonance to take effect. It is not possible for the filter to self - oscillate if no signal at all is fed into it.

If the KS 4 / KS 5 produces a high pitched whistling sound, it is probably due to this knob is being adjusted too far clockwise. If this self-oscillating effect is not desired, keep the Resonance control away from the extreme clockwise setting. Increasing the Resonance is very good for bringing out modulation (movement or change) in the filter Cut off frequency, such as in Acid bass lines and other very edgy sounds.

OVERDRIVE Knob

This knob controls how much the filter is overdriven. When used in large amounts it will have the effect of making the sound richer and slightly distorted.

MOD ENV DEPTH Knob

Controls the amount of change to the filter Cut off (set by the FREQUENCY knob) by the Modulation Envelope. In its central position there is no change to the filter Cut off frequency. Adjusting the knob anticlockwise from centre will introduce an increasing amount of negative modulation.

The filter will close as the MOD ENV runs through its cycle. Adjusting the knob clockwise from centre will introduce an increasing amount of positive modulation. The filter will be opened by the MOD ENV.

SLOPE Button

Controls how drastically the frequencies above (Low Pass), below (High Pass) or around (Band Pass) the Cut off point are removed from the sound. When the 12dB position is selected, the Cut off slope is gentle so higher harmonics are not attenuated (reduced in volume) as sharply as they are when the 24dB position is selected.

TYPE Button

Determines whether the Filter is acting as a Low Pass, High Pass or Band Pass type.

LFO 2 DEPTH Knob

Controls the amount of change to the filter Cut off (set by the FREQUENCY knob) by LFO 2. In its central position there is no change to the filter Cut off frequency. Adjusting the knob anticlockwise from centre will introduce an increasing amount of negative modulation. The Filter will close and open in time with LFO2 (this creates the popular wow wow effect of LFO2 waveform is set to Triangle).

Adjusting the knob clockwise from centre will introduce an increasing amount of positive modulation. The filter will open and close in time with LFO 2.

NOTE : An external audio signal such as a microphone, guitar or CD player may be processed by the filter and effects. Refer to Page 51 in the **Advanced Features** Chapter for more details on setting up this feature.

More functions associated with the Filter can be found in the Filter Menu. See Page 37.

LFOs Section

There are two LFOs - Low Frequency Oscillators - available on the KS 4 / KS 5. These produce regular electronic variations which are too low to be heard when converted into audio vibrations. They can modify various elements of the sound, producing regular changes in pitch (vibrato), pulse width or filter Cut off.



SPEED Knob

Controls the speed of the selected LFO. An LED directly below the knob indicates the speed. Faster speeds are set by turning the knob clockwise. These are suitable for vibrato and tremolo effects. Slower speeds are more appropriate for Pulse Width changes or special effects.

WAVEFORM Knob

Selects the waveform shape for the selected LFO. As waveforms are selected, the WAVEFORM LEDs update to reflect the currently selected waveform and the screen displays the currently selected waveform type. The first four LFO waveforms are the traditional types commonly found on classic analogue synthesizers. Additional special waveform types (including rhythmic patterns) are also provided as detailed in the table below. When one of these is selected, the MORE LED will be lit. Experiment !

LFO Waveforms	
No.	Description
0	Sine
1	Tri-Angle
2	Sawtooth
3	Square
4	Sample & Hold
5	Sample & Hold Quantized
6	Cross Fade
7	Fast Attack - Medium Decay Expo Ramp
8	Fast Attack - Fast Decay Expo Ramp
9	Fast Attack - Very Fast Decay Expo Ramp
10	Medium Attack - Fast Decay Expo Ramp
11	Slow Attack - Fast Decay Expo Ramp
12	Very Slow Attack - Fast Decay Expo Ramp
13	Fast Attack - Medium Hold - Medium Decay Ramp
14	Fast Attack - Long Hold - Medium Decay Ramp
15	Fast Attack - Longer Hold - Medium Decay Ramp
16	Attack - Fast Decay - Second Decay Ramp
17	Attack - Medium Decay - Second Decay Ramp
18	Attack - long Decay - Second Decay Ramp
19	Blipper
20	Chromatic Up Ramp (Set Osc LFO amount to 30)
21	Major Chord Ascending
22	Major 7th Chord Ascending
23	Minor 7th Chord Ascending
Rhythm Paterns	
24	Pattern 1
25	Pattern 2
26	Pattern 3
27	Pattern 4
28	Pattern 5
29	Pattern 6
30	Pattern 7
31	Pattern 8

Sine Wave

Gives the smoothest continuous change in level to the LFO. When routed to pitch, it introduces vibrato or a siren effect dependent of its speed setting. When routed to Filter Cut off, a Wow Wow effect results.

Triangle Wave

Also gives a smooth change in level to the LFO in a similar manner to the Sine wave. As its name implies, the Triangle wave does not remain at the peak of its waveform cycle for as long as the Sine wave. When routed to pitch, it also introduces vibrato or a siren effect dependent of its speed setting. When routed to Filter Cut off, a Wow Wow effect results.

Sawtooth Wave

Generates a rising level which then jumps back down to zero level. Routed to the Filter Cut off, it produces a rhythmic pulse effect. Routing it to pitch produces siren type sounds.

Square Wave

Changes level instantly from minimum to maximum. Useful for trills and computer / game effects. Very effective when used to modulate Osc Pitch.

Sample and Hold

At a regular interval (governed by the SPEED knob), the level of the LFO jumps to a new random level and stays there until the next jump. This creates a rhythmic effect, particularly if routed to the Filter Cut off. Routing this to pitch gives a less musical result, but is useful for computer / random or machinery sound effects. A 'quantized' version is also available. Here, the waveform is either at the top or bottom of its cycle. The effect is similar to a square wave with an unpredictable pulse width setting.

Cross fade

A single -shot, linear decay from maximum to minimum level. This is useful for implementing crossfades with an LFO used as a modulator. With a positive modulation amount, this LFO waveform 'fades out' the modulation. With a negative modulation amount, this LFO waveform 'fades in' the modulation.

Curved Sawtooth

Similar to a standard sawtooth wave, but the waveform slope is in fact an exponentially decaying curve. When the LFO is used in ONE SHOT mode as a simple Envelope Generator (see below), a Curved Sawtooth's 'decay' often sounds more pleasing and natural than the straight, linear 'decay' of a standard Sawtooth wave.

Pattern trigger Waveforms

The last eight waveforms consist of rhythmic trigger patterns. These are especially effective when the LFO is synchronised to the internal or external MIDI clock. Experiment with the various patterns available to see which ones work best for the Program.

DELAY Knob

Controls how long after the note is struck the selected LFO begins to take effect. Fully anticlockwise and the selected LFO effect will begin immediately. Turning clockwise will cause the LFO effect to fade in. The time of the fade in is dependent on the knob position. This is used for delayed vibrato effects.

LFO Select Button

Selects which LFO the SPEED, WAVEFORM, DELAY and ONE SHOT controls relate to. Select position 1 for LFO 1 and 2 for LFO 2.

ONE SHOT Button

This button makes an LFO play its waveform for only one cycle whenever a keyboard note is played. An LED above the ONE SHOT button indicates when the currently selected LFO is in One Shot mode.

Normally, the LFOs cycle through their waveform cycles continuously. Setting an LFO to operate in One Shot mode when it has its SPEED parameter set to a fairly slow value allows an LFO to be used (in effect) as a fairly simple Envelope generator. In this case, the SPEED knob controls the duration of any 'Attack' and / or 'Decay' phases in the 'Envelope'.

Reversing the polarity of the amount of LFO modulation applied (for example, from -20 to +20) has the effect of mirroring the LFO waveform about the horizontal axis so that the 'Attack' phase becomes the 'Decay' phase and vice versa.

Envelopes Section - Volume, Headphones and Input Sockets

Envelopes Section

AMP and MOD Envelopes

The Envelopes are used to shape a sound throughout its duration. The AMP Envelope determines the volume of the sound with respect to its duration.

The MOD Envelope may be used to control other sound elements of the synthesizer throughout the duration of the sound. It can control Oscillator Pulse Width, Filter frequency and Oscillator Pitch.

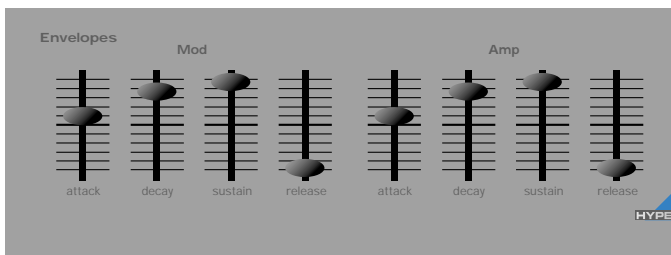

ATTACK Slider

Sets how quickly the envelope rises to its maximum level when a note is struck. Fully anticlockwise and this rise time or slope is very fast, less than half a thousandth of a second (instantaneous to the ear) increasing exponentially to twenty seconds when fully clockwise. To shorten attack times, turn this control towards zero and to lengthen attack times, turn this control towards maximum.

Note : When the attack time is set to Zero, the instantaneous rise time of the Envelope may produce audible 'clicks'. This is not a faulty condition and may be useful for the creation of certain sounds (for example, 'key clicks' on organ simulations). If this is undesirable, increase the Attack time until the clicks are inaudible.

DECAY Slider

Sets how quickly the envelope falls to a sustain level after the maximum level has been reached. Set to zero, this time is about one thousandth of a second (still instantaneous to the ear) increasing exponentially to twenty seconds when set to maximum. To shorten decay times, move this control towards zero and to lengthen decay times move this control towards maximum.

SUSTAIN Slider

Sets the level at which the envelope remains following the Decay phase, only while a key is being held on a controller keyboard (or there is a MIDI Note On command present). When set to zero, the envelope will decay to zero without being interrupted. As the control is moved towards maximum, the sustain level increases until, when at maximum, the sustain level is at its maximum level.

RELEASE Slider

Sets how quickly the envelope falls from the sustain level to zero once the note has been released. When set to zero, this time is about one thousandth of a second (instantaneous to the ear) increasing exponentially to twenty seconds when set to maximum. To shorten release times, move this control towards zero and to lengthen release times, move this control towards maximum.

Additional settings associated with the Envelopes can be found within the Envelopes Menu. See Page 39.

Volume, Headphones and Input Sockets



VOLUME Knob

This control adjusts the *overall output volume* on both the Left and Right master audio outputs found on the rear panel. It also controls the Headphone output, also on the rear panel. Using a mixing desk as a comparison, this control can be thought of as the channel volume fader.

PHONES Jack

Connect headphones to this jack when you wish to enjoy your KS Rack in privacy !

AUDIO INPUT Jack

Use this jack to process external sound sources through the KS Rack's Filter or Effects.

Effects Section

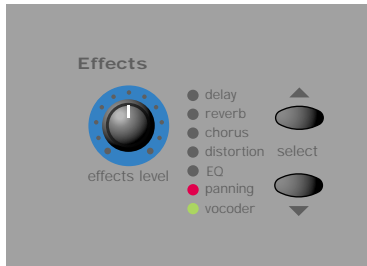

Seven different Effects which may be used simultaneously are provided. These effects are saved as an integral part of a sound when writing it to memory. In Performance Mode, each of the four Parts has its own complete set of Effects settings.

Adding Effects to a sound can dramatically enrich the overall sound texture. Some types of Effect are particularly useful in giving a sound a perceived position in three-dimensional space. Adding such sounds to final mix of a piece of music gives a much greater sense of 'depth'.

Each type of Effect has several settings associated with it which give fine control over how the Effect interacts with a sound. These settings may be changed using the various Effects menus. See Page 41 in the **Advanced Features** section for more details.

Effects SELECT Buttons

These two buttons are used to select which of the seven Effects is currently being edited. The seven types of Effect available are :

Delay

This Effect simulates the echoes which would be heard when a sound is reflected off of a hard, flat surface such as stone wall. The KS 4 / KS 5 actually incorporates a stereo version of this echoing effect.

To visualize a stereo echo, imagine a sound being produced between two stone walls. The echoes of the sound would bounce off each wall in turn until the echoes eventually dies away.

Use the EFFECTS LEVEL knob to introduce the Delay effect.

Reverb

The Reverb Effect simulates the acoustic properties of a room. In everyday life, the materials that a room is made of and its size determine how sound waves are reflected from the room's walls. Consider as an example, how different a sound is when heard in bathroom with tiled walls. Singing in particular can be dramatically improved !

Chorus

This is a swirling, stereo Effect, often useful for 'fattening up' a sound, creating an impression that several synthesizers are being played in unison, rather than just one.

This effect is actually achieved by slightly detuning the sound and adding it back to the original signal.

A similar, related effect to Chorus is the Phaser. Phasers phase-shift certain frequencies of a sound and add them back to the original signal. This gives a sound passed through a Phaser, a distinctive swishing quality. At extreme settings, this can sound similar to jet plane passing overhead!

In the Chorus Menu, it is possible to select whether the KS 4 / KS 5's Chorus Effect behaves as a standard Chorus or as a Phaser.

Use the EFFECTS LEVEL knob to introduce the Chorus or Phaser effect.

Distortion

As its name suggests, the Distortion Effect distorts a sound signal. Imagine how a sound recorded onto tape sounds when it has been

recorded with the record level far too high. Much loved by guitarists, distorted sounds have a very gritty, dirty quality to them. This is especially effective when applied to aggressive lead sounds.

The Distortion Effect also exaggerates any low-level harmonics present within the sound. Sounds using a level of RESONANCE in the Filter will especially benefit from added Distortion.

Use the EFFECTS LEVEL knob to introduce the Distortion effect.

EQ

The EQ (short for Equalization) Effect provides a way of diminishing or emphasizing a specific frequency range within the final sound. It is in fact, a form of Filter similar to the one found in the KS 4 / KS 5's Filter section. It performs a similar function, but it cuts or boosts certain frequencies.

The actual frequency range which will be cut or boosted is determined by the EQ Frequency Point (the **EQ Frequency** setting) which is set within the Effects Menu. See Page 45 in the **Advanced Features** chapter for details on how to set this.

The amount of cut or boost applied will depend on the position of the Effects LEVEL knob. When set to the 12 o'clock position, no cut or boost is applied. As the knob is turned anticlockwise from the 12 o'clock position frequencies *below* the EQ Frequency point will be boosted and frequencies above the point will be attenuated. As the knob is turned clockwise from the 12 o'clock position, frequencies *above* the EQ Frequency will be boosted and those below attenuated.

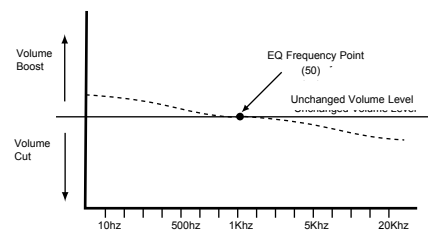

In the above example, The **EQ Frequency** point has been set to **50** and the **EQ LEVEL** set to **-10**. This has the effect of gently boosting the lower (bass) end of the frequency spectrum and cutting the higher (treble) frequencies.

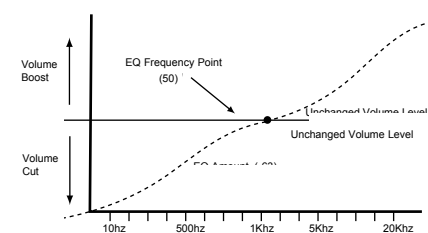

In this example, the **EQ LEVEL** has been set to its maximum possible positive setting of **63**. This results in a dramatic boost in the higher (treble) frequencies and a reduction in lower (bass) frequencies.

Panning

The Panning effect dictates where in the stereo field a sound is placed when heard through stereo speakers or headphones. It is possible to position a sound hard to the left, hard to the right or anywhere in between.

The Effects LEVEL knob introduces an amount of panning modulation which affects the location of the sound in the stereo field. When set fully counter-clockwise, the sound will only be heard in the position set by the manual pan control in the first page of the panning menu.

At the fully clockwise position, the sound will be move automatically from the left to the right-hand side at the rate determined by the panning rate control found in the Panning Menu.

Vocoder

Effects Section - Arpeggiator Section

A Vocoder is a device which analyzes selected frequencies present in an audio signal (called a *Modulator*), and superimposes these frequencies onto another sound (called the *Carrier*).

It actually does this by feeding the Modulator signal into a bank of band pass filters. Each of these filters (16 of them on the KS Rack) covers a set band in the audio spectrum from low to high frequencies.

The KS Rack's Vocoder always uses a Program (for example a string sound) for the Carrier. It is routed to another complete set of 16 filters which have the same frequency band settings as the bank of filters used for the Modulator. Each of the outputs from the 16 band pass filters in the Modulator bank control the volume of each of filters in the Carrier bank.

The final character of the vocoded sound will depend greatly upon the harmonics present in the Carrier Program. Programs very rich in harmonics (for example using Sawtooth Waves) will generally give the best results.

Typically, the Modulator signal used by a Vocoder would be a human voice speaking into a microphone. This creates the distinctive robot or 'talky' like sounds which have recently returned to popularity and are now being used more frequently in modern Pop and Dance music.

Bear in mind however, that the Modulator signal need not be restricted to human speech. Other types of Modulator signal can be used (for example, an electric guitar or drums) and can often give quite unexpected and interesting results.

Modulator audio signals such as from a microphone or CD should always be fed into the KS Rack's AUDIO IN socket, located on the front panel.

The pitch of the final vocoded sound will depend on whatever pitch the Carrier (currently selected Program) is playing. Notes can received via MIDI from an external keyboard or sequencer. These notes must be played simultaneously while the Modulator signal is present, otherwise the Vocoder effect will not appear to work.

The Vocoder is activated and balanced by using the Effect LEVEL knob. When this knob is turned fully counter-clockwise, the Vocoder is disabled. As the knob is slowly turned clockwise from the full counter-clockwise position, the Carrier signal will be heard. As the knob is moved towards the 12 o'clock position, the Carrier signal will diminish and the fully vocoded sound will become more prominent. At the 12 o'clock position, only the fully vocoded will be heard. The Carrier or Modulator signals will not be present. As the LEVEL knob is moved clockwise from the 12 o'clock position, more of the raw Modulator signal will be introduced until at the fully clockwise position, only the Modulator signal will be present.

More settings are available to help shape the final Vocoder Effect. These are detailed on Page 46 in the **Advanced Features** chapter.

Note : In Performance Mode, only one Vocoder can be used. In Performance Mode, this is always routed to Part 1. Altering any vocoder parameters will always result in Part 1 being affected - even if it is not currently selected for editing.

Note : If either of the Effect SELECT buttons are pressed while the Effects Menu is active in **Menu Mode**, the display will be updated to show settings relevant to the newly-selected Effect.

EFFECTS LEVEL Knob functions

Effects Level Knob			
Effect Selected	Function	Display	Value
Delay	Delay Level	Delay Send	0...127
Reverb	Reverb Level	Reverb Send	0...127
Chorus	Chorus Level	Chorus Send	0...127
Distortion	Distortion Boost	Distortion	0...127
EQ	EQ Cut/Boost	Equalisation	-64...63
Panning	Mod Depth	PAN Mod Depth	0...127
Vocoder	Vocoder On/Balance	Vocoder Bal	0...127

This control's function depends upon the Effect currently selected for editing by the SELECT buttons. In most cases, it will control the Effect's level, but there are exceptions. All possibilities are detailed in the above table.

Arpeggiator Section

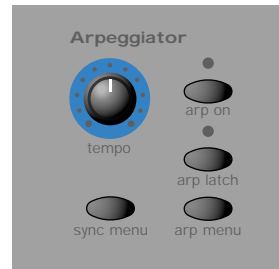

An Arpeggiator breaks down chords into single notes and plays them one at a time. For example, if a 'C' triad chord is held, the notes C, E and G will play one by one in sequence.

In Performance Mode, each Part can have its own Arpeggiator running with its own unique settings and time signature. Each Arpeggiator can be synchronised with the Arpeggiators used by the other Parts.

Which Arpeggiator pattern is used and how the sequence of notes are played is determined by settings of the functions located in the Arpeggiator Menu. See Page 54 in the **Advanced Features** chapter for more details on these.

TEMPO Knob

This controls the speed at which the Arpeggiator plays back its notes. When turned fully anticlockwise, the Arpeggiator will step through a sequence at 64 beats per minute. Clockwise movement increases speed. The maximum speed available is 191 b.p.m.

Note ; In **Performance Mode**, there is only one Arpeggiator TEMPO control which is common to all Parts. It is therefore not possible to have different Parts running at different TEMPO speeds.

When the Global **MIDI Clock Source** value (see Page 50) is set to **INT**, this knob also controls the tempo of any synchronized Chorus, Delay, Panning or EQ effects. See the **Hypersync** paragraph on page 29 and the Synchronisation Menu on page 52 for details on how to synchronise these.

When **MIDI Clock Source** is set to **EXT**, the tempo of any synchronized Arpeggiator, Chorus, Delay, Panning or EQ will be controlled by the tempo of the external sequencer instead of the TEMPO knob which will have no effect on the speed.

If this knob appears to have no effect on the tempo, the reason is probably due to **MIDI Clock Source** being set to **EXT** or that the external sequencer is currently stopped (stopped sequencers do not usually transmit MIDI Clock messages).

ARP ON Button

This activates / deactivates the Arpeggiator. While the Arpeggiator is activated, the LED above the button will be lit.

While an arpeggio is running, it can be stopped immediately by either pressing the ARP ON button again or by pressing the PERF or PROG buttons.

ARP LATCH Button

This button enables the Arpeggiator Latch feature which enables the Arpeggiator to remember the last set of notes played on the keyboard. When latched, the LED above the button is lit. The Arpeggiator sequence will continue to play even after notes have been released.

Once all notes on the keyboard have been released, the next chord to be played on the keyboard will clear the existing latch memory and only the newly played chord will be Arpeggiated.

Note : It is possible to control the Arpeggiator Latch On/Off from an external Computer/Sequencer/Keyboard. Transmit MIDI CC 64 (Sustain) with a value of 127 to turn the Arpeggiator latch **ON** and transmit controller number 64 with a value of 0 to turn the latch **OFF**.

MAIN FEATURES AND OPERATION

Arpeggiator Section - Hypersync Section

ARP MENU Button

Pressing this button accesses the Arpeggiator Menu. The LED above the MENUS button in the Mode / Keypad section of the front panel lights to confirm this. The parameters and features available in the Arpeggiator Menu are detailed on page 54.

Hypersync Section

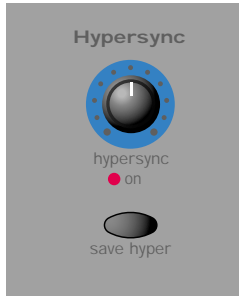

It is possible to synchronise many Effects parameters and other features such as LFO speed to a common, internal clock or to an external MIDI clock supplied by a sequencer. Synchronisation of each individual setting can be achieved by accessing the various parameters via the Synchronisation Menu. This can be very time consuming so to speed up the process, 16 editable 'Hypersync' templates are available which provide effective, musically synchronized settings.

When selected, a Hypersync template applies synchronisation settings to four Effects and four Program parameters. Settings for the Delay level, Chorus Level, Panning Depth and EQ Modulation Depth are also applied making a total of twelve Hypersync values.

Using tempo synchronized features can significantly enhance music production. The details of the eight values capable of being synchronized to internal or external MIDI clock are :

Delay

The time period of the Delay Effect is synchronized. The Delay level can be stored in the Hypersync template.

Chorus / Phaser

The time period of the Chorus / Phaser is synchronized. The Chorus / Phaser level can be stored in the Hypersync template.

Panning

The Panning time period is Synchronized. The Panning Depth setting can be stored in the Hypersync template.

EQ / Filter

The EQ / Filter sweep time is synchronized. The Modulation Depth setting can be stored in the Hypersync template.

LFO 1 & LFO 2

The amount of time taken for an LFO to play a single cycle of its waveform can be synchronized. Each LFO can be synchronized individually.

LFO 1 Delay & LFO 2 Delay

The delay time period for an LFO can be synchronized. Each LFO can be synchronized individually.

HYPERSYNC Knob

This selects which Hypersync template is applied to the Program (sound). The display indicates which template is applied when the knob is at non-zero. At the fully counterclockwise position, the Hypersync Menu will deactivate and the normal Program Mode or Performance Mode display will be activated.

When no Hypersync template is selected, all of the *original* parameter values stored in the Program / Performance are restored to the Sync and Effects settings. The Hypersync ON LED is not lit.

As the HYPERSYNC knob is moved clockwise, each of the sixteen templates are selected in turn. For example :

```
Hypersync          01
Syncopated Delay
```

The Hypersync ON LED lights to indicate a Hypersync Template has been selected. The number on the top line of the display indicates which of the sixteen templates is selected. For reference, each template is assigned a name which is shown on the bottom line of the display

When shipped from the factory, the first eight Hypersync templates are pre-configured.

When the any of these first eight templates are activated the display will show

```
Hypersync          01
Preset Table 1
```

The actual number will depend on the which number is selected. The preset table names may be edited, see the section on the following page, **save hyper**

Editing a Hypesync Template

Moving the HYPERSYNC knob displays the next Hypersync Template. (the program currently selected will change its sounds according to the Hypersync values). Once the desired Template has been selected, use the PERF / PROG / PAGE Buttons to access the three Hypersync editing pages.

Press the PERF / PROG / PAGE Up button. The display shows:

```
DELY CHOR EQ PAN
1bar 4th 2nd 8th
```

Here the synchronisation rates of the Delay, Chorus, EQ and Panning may edited. The cursor indicates which of the four parameters on the page can be altered with the PERF / PROG / DATA knob.

In the above example, the Chorus Delay sync is selected for editing. The SELECT Buttons can be used to move the cursor to select a different parameter for editing.

The tables found on page 52 gives the possible synchronisation settings for the various Effects. It is also possible to set each parameter to **NCH** (no change) or **FRN** (Free Run) . When set to **FRN**, the Effect is not synchronised and will run at its own independent tempo.

Hypersync Section

Pressing the PERF / PROG / PAGE Up button again, shows :

```
LFO1..DEL LFO2..DEL
2nd 16th FRN 2bars
```

Here the LFO 1 and LFO 2 synchronisation settings may be edited. The LFO 1 rate and delay settings are the first two entries from left to right. The LFO 2 rate and delay settings are third and fourth entries.

In the above example, the LFO 1 delay sync is selected for editing with the PERF / PROG / DATA knob. The SELECT Buttons can be used to move the cursor to select a different parameter for editing.

The table found on page 52 gives the possible synchronisation settings for the LFOs. It is also possible to set each parameter to **NCH** (no change) or **FRN** (Free Run) . When set to **FRN**, the Effect is not synchronised and will run at its own independent tempo.

Pressing the PERF / PROG / PAGE Up button again, shows :

```
DELY CHOR EQ_D PAN
93 127 +63 NCH
```

Here the Delay Level, Chorus Level, EQ Modulation Depth and Panning Modulation Depth can be edited. In the above example, the Chorus Level is selected for editing with the PERF / PROG / DATA knob. The SELECT Buttons can be used to move the cursor to select a different parameter for editing.

It is also possible to set each parameter to **NCH** (no change).

Note: If a different Hypersync template is selected before the current template has been written to memory, any edits made will be lost.

SAVE HYPER Button

Pressing this button writes an edited Hypersync template into memory. The LED above the button indicates whether any edits have been made to the currently selected template.

When the button is pressed, the display shows :

```
Write to ?      01
Syncopated Delay
```

The display will now show the destination memory number where the Hypersync template is about to be saved to. In this example, **Write to 01**.

Notice that the destination memory is initially set to the currently selected Hypersync Template's number. It is possible to save a Template to a different memory location. Use the PERF / PROG / DATA knob or Keypad buttons to select a different destination memory if required.

Any of the sixteen available Hypersync Template memories can be selected. Press the SAVE HYPER button again to proceed. The display shows :

```
Name Hypersync  01
'Syncopated Delay'
```

On this display it is possible to edit the Template's name. Use the Left and Right SELECT buttons to move the cursor within the Template's name text. Use the PERF / PROG / DATA knob to select the character located at the cursor.

Once the name has been entered, press the SAVE HYPER button once again to write the Hypersync template to memory.

During the saving procedure, saving can be abandoned at any point by pressing the PERF or PROG buttons. **Program Mode** or **Performance Mode** is selected without saving the Hypersync Template.

NOTE: When shipped from the factory, the global memory protect switch is set to on. The memory protect switch is a safety feature designed to prevent memories from being overwritten by accident. Therefore, in order to save a Hypersync Template, the global memory protect must be switched off. See page 6 for details on how to do this.

As soon as the Hypersync Template is saved to memory, the display will revert back to the display showing the name and number of the Hypersync Template.

Saving a Program after Hypersync has been applied

Once a Hypersync template has been applied to a Program, the audible effects to the sound will be noticed immediately. If these settings are required permanently, the Program must be saved in the normal way. To do this refer to Page 6 - Saving a Program. If they are not permanently required, it is only necessary to reload the Program to restore the original sound or return the Hypersync knob to the zero position.

Once the Program has been saved, applying the same Hypersync Template setting to it will naturally have no effect. If desired the Hypersync Template may be edited such that an entirely new set of setting will be introduced when Hypersync is applied.

SYNC MENU Button

Pressing this button accesses the Synchronisation Menu. The parameters and features available in the Synchronisation Menu are detailed on page 52.

Part Edit Section

This section contains all the controls associated with configuring the individual Parts when used in **Performance Mode**. In **Program Mode**, these controls are still available for use, but behave as if only one Part is available - Part 1.

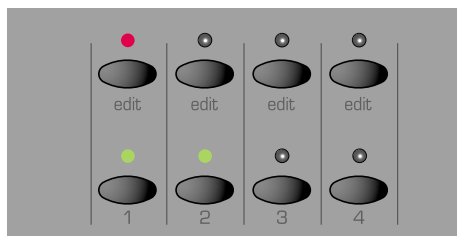

individual Parts on the fly in a live performance situation. Inactive Parts are in effect, 'muted' and do not sound or respond to MIDI messages. Activating a 'muted' Part restores normal operation where it can resume playing or responding to MIDI.

PART LEVEL Knob

Sets the currently selected Part(s) volume level. This allows the correct balance between individual Parts in a Performance to be achieved. In **Program Mode**, this knob will only affect Part 1.

Part EDIT Buttons

These four buttons determine which Part will be edited by the front panel controls. In **Program Mode**, Part 1 is always selected for editing and cannot be de-selected.

In **Performance Mode**, any of the four Parts can be selected for editing. The status of the Part EDIT buttons determine which of the parts will play when using the keyboard.

If a Performance is configured for a layered type sound (parts are set to use the same MIDI channels), the keyboard will only play ALL the parts whose MIDI channels match the channel used by the part that is currently selected by the EDIT button. In this way the complete layered sound (that may be a multiple of many parts) may be auditioned.

By switching on and off the parts (pressing the buttons below the green LEDs) each individual part may be auditioned.

If a Performance is configured multi-timbrally (parts are set to use different MIDI channels), the keyboard will only play the part currently selected by the EDIT buttons. It would generally be undesirable to audition a collection of parts that contain different sounds all at once.

Multi-timbral Performances are for use with an external sequencer such that different sounds on different MIDI channels can be triggered throughout a song.

Part MENU Button

Pressing this button accesses the Part Menu. The LED above the MENUS button lights to confirm this. The parameters and features available in the Part Menu are detailed on page 55.

Part Active Buttons

These four buttons determine which Parts are in use.

In **Program Mode**, Part 1 is always active and cannot be de-activated. No other part can be activated since a single sound only can be played.

In **Performance Mode**, any combination of the four Parts can be used by a Performance. The LEDs above the Part Active buttons indicate which Parts are currently active. An inactive Part will not respond to incoming MIDI messages or can be played by the keyboard. An inactive Part cannot be edited.

The Part Active buttons also provide a convenient way of 'muting'

Display and Data Entry Section

Display and Data Entry Section

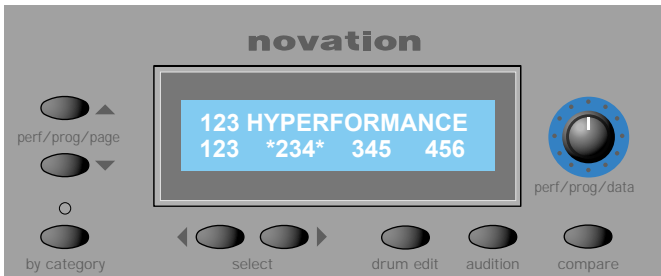

As well as containing the display, this section also contains controls, whose function varies according to which *mode* the KS Rack is currently in. For more information on modes, refer to the section **Modes and Menus** on Page 19.

PERF / PROG / PAGE Buttons

While in **Program Mode** or **Performance Mode**, these buttons may be used to advance / decrease the currently selected Program / Performance. If pressed and held down, the Programs or Performances will start advancing / decreasing in steps of ten Programs at a time.

While in a **Menu**, these buttons are used to move up and down through the various linked pages within the currently selected menu.

PERF / PROG / DATA Knob

In **Program Mode** or **Performance Mode**, this knob may be used to step forwards or backwards through the available Programs or Performances. The interval used in stepping through the Programs or Performances is determined by how quickly the knob is turned.

In a **Menu**, this knob is used to adjust the value of the function relevant to the currently selected Menu Page.

BY CATEGORY Button

Pressing this button enables the category search feature. When category searching is enabled, the LED above this button is lit and the PERF / PROG / DATA knob will only search for Programs within the currently selected category. See page 4 for details on how to select categories and how category searching operates.

Category searching cannot be used to select Performances.

Left and Right SELECT Buttons

Sometimes within menus and on the **Performance Mode** display, several parameters are available for editing on the same display screen. These buttons are used to move the cursor to a different parameter on-screen. The PERF / PROG / DATA Knob can now be used to adjust the newly-selected parameter.

AUDITION Button

When pressed, the currently selected / edited Program will play a short sequence of notes. This feature is useful in hearing what the Program sounds like without having to play a connected Master keyboard or sequencer.

DRUM EDIT Button

This button is selected a Drum Map at any time. Once in a Drum Map, holding this button down and pressing a key on the keyboard will select the Drum sound for editing on the front panel.

Using this button is equivalent to selecting the Program in a Drum Map by the conventional means of using the PERF / PROG / PAGE buttons, PERF / PROG / DATA knob or numeric keypad buttons, but provides a convenient, direct shortcut to the appropriate Drum Program in **Program Mode** or **Performance Mode**.

COMPARE Button

While this button is held down, the currently selected Program (if in Program Mode) or Part (if in Performance Mode) will be recalled from its original memory location, temporarily losing any edits that have been made to the Program since it was originally selected.

Releasing the button restores the edit-buffer, bringing back any changes made to the Program since it was originally selected. In Performance Mode, any part selected for editing with the EDIT buttons is compared.

During the process of saving a Program or Performance to a memory location, the COMPARE button compares the current Program / Performance against the *destination* memory as specified in the saving procedure (see pages 6 and 8).

When saving a Performance, it is the *whole Performance* at the destination which is compared, not just the currently selected Part(s).

Displaying a Program / Performance Edit

When playing is useful to know whether the current selected sound or Performance has been modified in any way from the originally saved settings.

If any changes have been made to a Program, (a knob has been tweaked or a button has selected a different function) an asterisk will appear in the display soon after the tweak or button press has been made. It will appear immediately to the left of the Program number when in **Program Mode**.

```
Edited program *123
```

If the change is reversed (the control returned to its position as defined by the original Program), the asterisk will disappear.

```
Edited program 123
```

If a change has been made to a Performance or Part Program, the same applies. This is how the **Performance Mode** screen would appear if edits had been made to the Programs in Parts 2 and 4.

```
Edited perf *123
123 *234 345 *456
```

Mode and Keypad Section

This section contains buttons associated with Mode selection, writing Programs and Performances to memory and selecting Programs or Performances directly by three-digit entry.

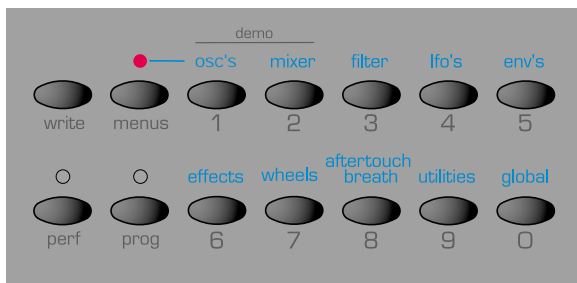

WRITE Button

Pressing this button starts the procedure for saving Programs or Performances into memory. The procedure for saving Programs is detailed in the section **Saving a Sound** on page 6. The procedure for saving whole Performances or Part Programs is detailed in the section **Saving a Performance** on page 8.

If however, this button is pressed while the Global Menu is currently active in a **Menu**, instead of saving the currently edited Program, the current settings of all Global parameters will be saved into memory. (The display will briefly show 'GLOBALS SAVED'). The next time the machine is switched on, these values will be remembered.

MENUS Button

Pressing this button selects a **Menu**. The LED located above the MENUS button will be lit. If already in a Menu when the button was originally pressed, the Menu will be cancelled and **Program Mode** will be selected (if currently in **Program Mode**) or **Performance Mode** (if currently in **Performance Mode**).

From a **Menu**, **Program Mode** may be also be selected at any time by pressing the PROG button or **Performance Mode** selected by pressing the PERF button.

PERF Button

Pressing this button selects **Performance Mode** and the LED above the PERF button lights.

In **Performance Mode**, a new Performance may be selected by either the PERF / PROG / PAGE buttons, the PERF / PROG / DATA knob or by typing in a three digit entry by using the 0 - 9 keypad / Menu Select buttons.

PROG Button

Pressing this button selects **Program Mode**. The LED above the PROG button lights..

In **Program Mode**, a new Program may be selected by either the PERF / PROG / PAGE buttons, the PERF / PROG / DATA knob or by typing in a three digit entry by using the 0 - 9 keypad / Menu Select buttons.

0 - 9 Keypad / Menu Select Buttons

In a **Menu**, these buttons may be used to switch to a different Menu.

At all other times, pressing one of these buttons will initiate **Program Mode** or **Performance Mode**. A three-digit entry must be entered so that the appropriate Program or Performance may be recalled from memory.

For this reason, it is important to make sure that the MENUS button has already been pressed before using these buttons to select a different Menu.

The Oscillator Menu

This chapter details the many advanced features available. Most of these are found in the various Menus available. See page 19 for details on selecting Menu Mode.

Each of the various Menus available will now be presented in more detail.

The Oscillator Menu

To complement the front panel controls in the Oscillator section, there are many other functions located in the Oscillators Menu. This Menu is selected by pressing the keypad '1' button when the MENUS button in next to keypad button one is active. Use the PERF / PROG / PAGE up/down buttons to scroll through the Menu functions available - See table below.

Oscillator Menu			
Page	Function	Display	Value
1	Polyphony Mode	OSC Pol Mode	MONO...POLY 2
2	Unison Voices	OSC Unison	OFF...8
3	Unison Detune	OSC Uni Dtune	0...127
4	VCO Drift	OSC Vco Drift	0...127
5	Preglide Semitones	OSC Preglide	-12...12
6	Portamento Mode	OSC Porta Mode	EXP-LIN
7	Start Phase	OSC Start Phase	OFF 0...127
8	Osc 1 - 2 Sync	OSC 1>2 Sync	OFF-ON
9	Osc 2 - 3 FM Manual Level	OSC 23 FM Level	0...127
10	Osc 2 - 3 FM Env Amt	OSC 2>3 FM AEnv	-64...63
11	Osc 2 - 3 FM LFO1	OSC 2>3 FM Lfo 1	-64...63
12	Osc Fixed Note Replay	OSC Fixed Note	0...127

Polyphony Mode (Menu Page 1)

This setting determines if the Program plays polyphonically or monophonically.

Voice mode	
Display	Function
MONO	Mono No Auto Glide
MONO AG	Mono with Autoglide
POLY 1	Normal Poly Mode
POLY 2	Poly - no note layering

When set to **MONO** or **MONO AG**, the Program plays monophonically (ie only one note can be sounded at any one time). If a chord is played on the keyboard, it will be noticed that as each individual note is released, the note sounding will revert back to the nearest played note.

The **MONO AG** setting enables 'Auto glide' (portamento) to be triggered whenever a note is played on the keyboard *before* the previously held down note has been released (legato playing). Using 'Auto glide' in this way can greatly add expressiveness to a Program. It is especially effective when applied to lead type sounds.

The monophonic settings are often useful when replicating sounds in the 'real world' which would normally be played monophonically, for example a bass guitar.

As their name implies, the **POLY 1** and **POLY 2** settings allow polyphonic operation.

POLY1 allows successive playing of the same note(s) to be 'stacked' together, gradually producing a louder sound texture as the note(s) are repeatedly played.

With **POLY2**, if the same note(s) are played repeatedly, they will use the same synthesizer voices as used previously, thus avoiding the 'stacked note' effect.

Unison Voices (Menu Page 2)

Unison allows more than one voice to be used for each note played on the keyboard. This effect is useful when a very thick sound is required.

Up to eight voices may be layered one on top of another when just a single note is played.

To listen to the effect, select Page 2 in the Oscillator Menu, turn the PERF / PROG / DATA knob clockwise until the display shows **2**. Play a note and listen to the sound. It will become thicker sounding. Increasing the number of notes to a maximum of 8 will result in very dense sounding textures.

Note: As more voices are assigned to Unison, the available polyphony for all Parts will reduce accordingly. For example, using 8 voices in Unison mode will result in just two notes of polyphony being available!

Unison Detune (Menu Page 3)

Unison Detune is used in conjunction with Unison Voices as described above. When using more than one voice per note, the Unison detune amount sets how much each voice is detuned relative to the others. Adjust the amount until the desired effect is heard.

VCO Drift (Menu Page 4)

Controls the amount of tuning drift for the Oscillators. Setting a modest value, 10 for example will cause each Oscillator to slowly drift fractionally out of tune. Classic Analogue Synthesizers were known to gradually go out of tune as the internal circuits heated up. This 'instability' actually helped to give them their own unique character!

Preglide Semitones (Menu Page 5)

A Preglide is applied to the pitch of the Oscillators starting at a pitch determined by the Preglide amount in semitones. Gliding up from a pitch occurs when the display indicates between **-12** to **-1**, and gliding down from a pitch occurs when the display indicates between **1** to **12**. At a setting of **0**, no preglide is applied.

The time it takes to complete the Glide is determined by the PORTAMENTO knob on the front panel. The Preglide is triggered with every note received.

Portamento Mode (Menu Page 6)

Determines the type of curve applied when PORTAMENTO is used. Two types of curve are available, Exponential and Linear. Linear Portamento sweeps through note intervals at a constant rate. When Exponential Portamento is used, the rate of sweep decreases throughout the note sweep's duration.

Start Phase (Menu Page 7)

When synthesizing percussive or plucked type sounds, there is a lot of detailed waveform information at the beginning of the sound. It is often useful to have the Oscillator wave start in *exactly* the same place every time a key is pressed.

The start phase option allows the precise starting point of the Oscillator wave to be determined. At a setting of **0**, the wave will start at zero Degrees. Each increment on the display shifts the start point of the wave approximately 3 degrees. The wave will start at a random phase when set to **OFF**.

Osc 1 - 2 Sync (Menu Page 8)

This function provides a way of producing interesting, piercing, metallic sounds. It does this by using the frequency of Oscillator 1 to periodically restart the waveform used by Oscillator 2. This technique is known as Oscillator Sync. Set this to **ON** to activate Sync.

It should be remembered that the *frequency* of a waveform corresponds to the number of waveform peaks (cycles) over a given period of time. The frequency also determines the Oscillator's pitch.

Therefore if Oscillators 1 and 2 are detuned from each other, Oscillator 2's waveform will be periodically interrupted and started again from the beginning of the waveform cycle every time Oscillator 1's waveform begins a new cycle.

The diagram on the following page illustrates this.

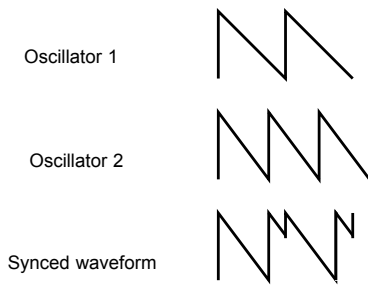

It can be seen that the resulting synced waveform has subsequently been modified into a different shape. Altering a waveform's shape in this way introduces new harmonics into the sound which gives the resulting waveform its distinctive synced sound qualities.

It should be realised that the greater the difference in tuning between the Oscillator waveforms, the more pronounced the sync effect will become, since more drastic changes will be made to the final synced waveform. Changing the pitch of one of the Oscillators during the duration of a note (for example, modulated by an LFO) will add a dynamic quality to the synced sound.

FM Synthesis

The next two menu options allow sounds based on FM (Frequency Modulation) synthesis to be created. Before looking at the operations of these controls, a little explanation of FM synthesis follows.

Earlier in this manual, the basics of subtractive synthesis were introduced. Terms such as harmonics, timbre, waveforms and oscillators became familiar.

FM Synthesis is the technique of using *one waveform to Frequency Modulate - FM- another to produce a resultant more harmonically complex waveform.*

The following diagram illustrates that the higher the modulation between the Modulating wave and the Carrier wave, the more the waveform changes.

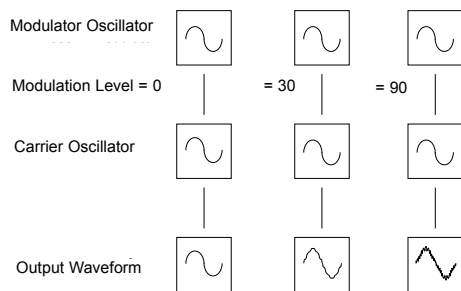

In the illustration, the Oscillators are producing Sine waves. It is the *change* in harmonics over time that makes a sound interesting to our ears.

In FM synthesis, an envelope generator is inserted between the modulator and carrier waveforms so that there is control over of how much of the frequency modulation is taking place with respect to time. Adding this envelope constructs the basic FM building block as shown in the next illustration.

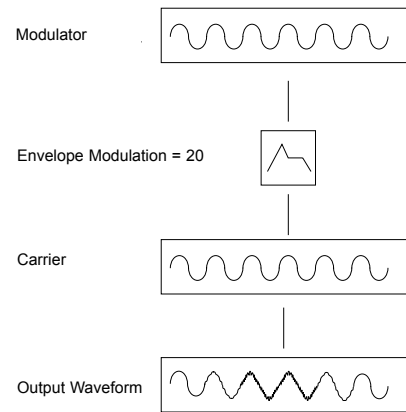

It can be seen that the output waveform begins, being identical to the carrier, but becomes more complex (harmonics are added) as the amount of FM modulation increases via the envelope. It then returns to a simple wave again as the envelope decays.

The timbre of the Waveform is changing with time. This is the opposite of subtractive synthesis where a *low pass Filter* is used to *remove harmonics*.

To complete a simple synthesizer, a further envelope is added to control the output volume.

The complete FM building block is illustrated below.

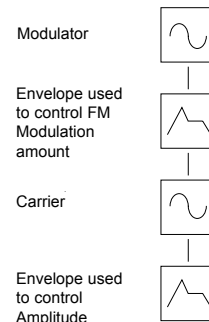

OSC 2 is able to FM OSC 3 via a dedicated FM envelope. *It is important that it is realized that this Envelope is used only for FM purposes and is not one of the Envelopes available on the front panel.*

The diagram below shows in block diagram format how the KS Rack can produce FM sounds.

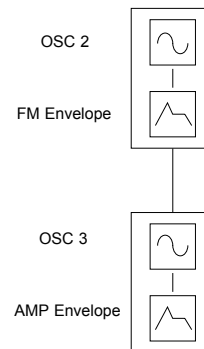

The easiest way to be totally familiar with FM is to take one of the factory preset FM sounds, for example **Bank 2 - 09 (Sound 209)**, a bell sound and to experiment by modifying the various FM settings.

The Oscillator Menu

OSC 2 - 3 FM Manual Level (Menu Page 9)

Controls the amount that Oscillator 3 is directly Frequency Modulated by Oscillator 2. Whilst playing a note, adjust this value by using the PERF / PROG / DATA knob. Notice that increasing amounts of modulation level make the sound more metallic.

OSC 2 - 3 FM Amount from AD envelope (Menu Page 10)

Many sounds have complex harmonic movements at the start of the sound. Introducing envelope modulation with a fast attack and decay time to control the FM amount will simulate this fast changing harmonic effect.

There is an additional envelope located - See below - that can be applied to control the FM amount between the oscillators 2 and 3.

The amount of modulation from the envelope can be adjusted by using the DATA knob. Notice how the 'spit' at the beginning of the sound may be accentuated. Experiment with Oscillator 2's pitch using the OCTAVE button and the SEMITONE and DETUNE knobs.

Adjusting the AD Envelope Attack and Decay Times

Changing the AD Envelope attack and decay times (which is used as the FM modulation envelope) is done from within the Envelopes Menu. See Page 39 for details.

OSC 2 - 3 FM Amount from LFO 1 (Menu Page 11)

Allows the FM amount between Oscillators 2 and 3 to be modulated by LFO 1.

Osc Fixed Note Replay (Menu Page 12)

Rather than playing chromatically across the keyboard (as is the usual case), a sound may be set to just play a fixed note - pitch - when ANY note is played from the Keyboard or when triggered from an incoming MIDI note on event.

This feature mostly used for sounds that are in a Drum Map.

Experiment by selecting the Drum Map (pressing the DRUM EDIT button), selecting a Drum sound for edit (Hold down the DRUM EDIT button and play a key on the keyboard) and selecting page 12 in the OSCs Menu.

Use the DATA knob to change the pitch of the sound. If desired, save the sound in the normal way.

By using this feature on Drum sounds, new interesting timbres may be achieved.

The Mixer Menu

To complement the front panel controls in the Mixer section, there are other functions located within the Mixer Menu. This is selected by pressing the keypad '2' button while in a **Menu**.

Use the PERF / PROG / PAGE up/down buttons to scroll through the Menu functions available - See table below.

Mixer Menu			
Page	Function	Display	Value
1	LFO2 Level Mod to OSC 1	MIX Osc1 L2 Lev	-64...63
2	Noise Type	Mix Noise Type	White - Band

LFO 2 Level Modulation to OSC1

LFO2 may be routed to control the level of the volume from Oscillator 2 in the Mixer section. This is useful if timbre from OSC to be faded in and out on a once only basis (LFO2 set to one-shot mode) or cyclically. Listen to some of the factory presets to hear this function.

Noise

This setting determines the frequency characteristics of the Noise signal available from the Mixer's NOISE / RING / EXT knob. Four different types of Noise are available.

0 - This is standard White Noise, with all frequencies present in equal amounts.

1 - This is a high pass filtered Noise and is useful for constructing certain types of percussion type sounds.

2 - This is a band pass filtered Noise and is also useful for constructing certain types of percussion type sounds.

3 - This is different type of high pass filtered Noise and again it is useful for constructing certain types of percussion type sounds.

The Filter Menu

To complement the front panel controls in the Filter section, there are other functions located within the Filter Menu. This is selected by pressing the keypad '3' button while the KS Rack is in **Menu Mode**.

Use the PERF / PROG / PAGE up/down buttons to scroll through the Menu functions available - See table below.

Filter Menu			
Page	Function	Display	Value
1	Tracking	FILT Kbd Track	0...127
2	Velocity Sensitivity	FILT Velocity	0...127
3	Q Normalise	FILT Q Normalise	0...127

Tracking (Menu Page 1)

This controls the amount of change to the filter Cut off (set by the FREQUENCY knob) by the pitch of the note played. When the PERF / PROG / DATA knob is turned fully anticlockwise, there is no change to the filter Cut off frequency. With clockwise movement there will be an increasing amount of modulation. The filter will be opened more as higher notes are played on the keyboard. This control is used to define how the timbre of a sound changes over the keyboard.

At the fully clockwise position, the filter tracks the pitch changes in a 1 to 1 ratio. This means that with RESONANCE set to a high level, the pitch of the Filter's self - oscillation will increase in semitone steps as notes are played on the keyboard. This effect is akin to adding an extra (Sine Wave) Oscillator to the sound when notes are played on the keyboard.

Velocity Sensitivity (Menu Page 2)

This setting is used to modulate the Cutoff FREQUENCY of the Filter up or down in response to the velocity information present in incoming note messages or notes played on the keyboard.

Set in the range **-1 to -64**, the Filter will close (the Cutoff FREQUENCY will decrease) as velocity data is applied. With a range of **1 to 63**, the Filter will open (the Cutoff FREQUENCY will increase) as velocity data is applied. Greater values will open (increase the Cutoff FREQUENCY) as velocity data is received. At a setting of **0**, note velocity will have no effect.

Q Normalise (Menu Page 3)

This value controls the Resonance Normalise. At zero, when resonance is applied, the main audio signal will remain at normal levels. Adjusting clockwise will reduce the signal level in relation to the resonance level.

This feature enables the Filter to emulate many of the classic Filters such as the Moog type, Oberheim type and Roland TB303* type.

* Trademark of the ROLand Corporation of Japan

The LFOs Menu

The LFO Menu

To complement the front panel controls in the LFO section, there are many other functions located within the LFOs Menu. This is selected by pressing the keypad '4' button while the MENUS buttons is active.

Use the PERF / PROG / PAGE up/down buttons to scroll through the Menu functions available - See table below.

LFO Menu			
Page	Function	Display	Value
1	LFO1 Velocity	LFO1 Velocity	-64...63
2	LFO1 Triggering	LFO1 MonoDelTrig	SGL-MLT
3	LFO1 Keysync	LFO1 Keysync	OFF-ON
4	LFO1 Keysync Phase Offse	LFO1 Init Phase	OFF-ON
5	LFO1 Polarity	LFO1 Unipolar	OFF-ON
6	LFO1 Common to all Voices	LFO1 Common	OFF-ON
7	LFO2 Velocity	LFO2 Velocity	-64...63
8	LFO2 Triggering	LFO2 MonoDelTrig	SGL-MLT
9	LFO2 Keysync	LFO2 Keysync	OFF-ON
10	LFO2 Keysync Phase Offse	LFO2 Init Phase	OFF-ON
11	LFO2 Polarity	LFO2 Unipolar	OFF-ON
12	LFO2 Common to all Voices	LFO2 Common	OFF-ON

LFO Velocity (Menu Pages 1 & 7)

The intensity of the LFO may be set to respond to velocity. As an example of this. Set the LFO1 depth control to a positive value from the front panel such that pitch modulation occurs on Oscillator 1. Using this Menu, setting the LFO1 velocity to a positive value. Notice that, when pressing a key on the keyboard, a soft press results in a very small amount of pitch modulation or wobble and a hard press results in a large amount.

When an LFO is used in the mixer section as a modulation source, this feature is useful for controlling the volume of each Oscillator in proportion to how hard a key is struck.

LFO Delay Triggering (Menu Pages 2 & 8)

When the Voice mode is set to any of the Mono options (see Page 23), different LFO delay settings are available for legato playing styles (notes overlapping).

When the first note of a musical phrase is played, it might be desirable to have an initial delay on the LFO. (If the LFO is routed to pitch modulation, a vibrato effect would be introduced after the delay time). For the remaining legato notes, a non interrupted vibrato might be required. Setting this to **SGL** (single) achieves this.

Setting this to **MLT** (Multi) sets the LFO delay to apply to every note played.

LFO Keysync (Menu Pages 3 & 9)

Each LFO waveform may be restarted every time a key is pressed. For example, if a siren type sound effect was required, an LFO using a sawtooth wave would be set to positively modulate pitch. Each time a new key is pressed, the pitch would climb from the same point (because the LFO waveform would be restarted) rather than being at an undetermined pitch position.

Note : If the **LFO Common To All Voices** function (detailed below) is set to **ON** for the LFO, *altering this value will have no effect*. How a keysync is applied to the LFO is determined by the changing the **Global Sync Mode** settings (found in the Global Menu). See Page 35 in the **Advanced Features** chapter for details.

LFO Keysync Initial Phase Offset (Menu Pages 4 & 10)

This setting provides an alternative point in the LFO's waveform cycle where the waveform will be restarted from when **LFO Keysync** is set to **ON**. To hear the difference, set a slow LFO to modulate Oscillator pitch modulation and experiment with different LFO waveforms and **LFO Keysync Phase Offset** settings.

LFO Polarity (Menu Pages 5 & 11)

This setting determines whether the LFO modulates in a positive and negative direction or solely in a positive direction.

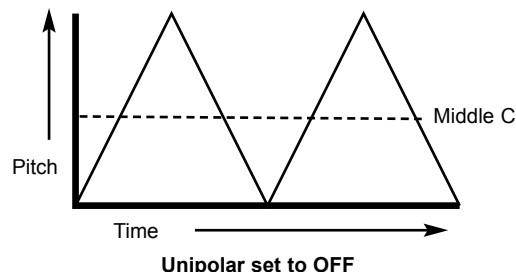

As an example of how this works, imagine an LFO assigned to modulate an Oscillator's pitch while a key of middle C is played on the keyboard. When **Unipolar** is set to **OFF**, the pitch would be modulated between a note some interval *below* middle C and another note at an equal interval *above* middle C. The interval between the notes is determined by the modulation amount applied to the pitch by the LFO.

If the LFO was modulating the pitch with **Unipolar** set to **ON**, the pitch would only be modulated in a positive direction, so the pitch would modulate between middle C and another note located at some interval above.

It is often useful to set an LFO's **Unipolar** setting to **ON** if an LFO is being used as a simple Envelope Generator (by setting its **ONE SHOT** mode).

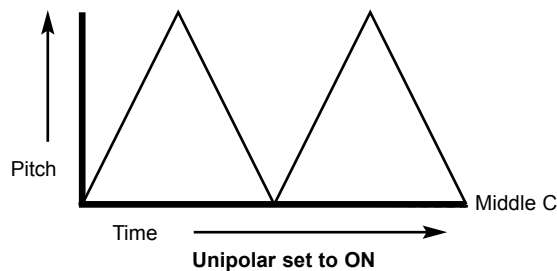

LFO Common to all voices (Menu Pages 6 & 12)

Each of the 16 voices (notes of polyphony) have two LFO's - 32 in total. The sixteen LFOs designated LFO 1 (one per voice) may be 'phase' locked together and similarly the sixteen LFO's designated LFO 2 may be locked.

To illustrate this, assume the LFO waveform is a triangle wave and at a specific moment in time all sixteen are at the beginning of a the rising portion of the wave. At a later point in time all will be at the beginning of the falling portion of the wave. If this waveform is applied to pitch, when a number of notes are played simultaneously, the pitch of all the notes will rise and fall at precisely the same time.

If the LFO is not locked, then each wave will be at a random position relative to the others. In this pitch modulation example, the pitch of all the notes will be changing 'out of synchronization' with others.

Imagine a String section of eight violin players. With the LFO locked and the LFO being used to create a vibrato, all sixteen of the string players would have the bow in exactly the same position. This obviously does not occur in a real string section and if it did the sound would be very unusual. In reality, each player's bow would be in a different position which gives the strings a 'chorus' type sound. To simulate the string section the LFOs would not be locked.

Setting this to **ON** will 'lock' the LFO.

When **LFO Common To All Voices** is set to **ON**, changing the setting of the **LFO Keysync** function will have no effect. Instead, how a keysync is applied to the LFO is determined by the setting of the **Global Sync Mode** value (found in the Global Menu). See Page 51 in the **Advanced Features** chapter for details.

The Envelopes Menu

To complement the front panel controls in the Envelopes section, there are many other functions located in the Envelopes Menu. This is selected by pressing the keypad '5' button when a Menu is selected. Use the PERF / PROG / PAGE up/down buttons to scroll through the Menu functions available - See table below.

Envelope Menu			
Page	Function	Display	Value
1	Program Level dB	ENV Prog Boost	0.. 30
2	Velocity to Amp Env Level	ENV Velocity>Amp	-64...63
3	Velocity to Mod Env Level	ENV Velocity>Mod	-64...63
4	Velocity to AD Env Level	ENV Velocity>AD	-64...63
5	Amp Envelope Triggering	ENV Amp MonoTrig	SGL-MLT
6	Mod Envelope Triggering	ENV Mod MonoTrig	SGL-MLT
7	AD Envelope Triggering	ENV A/D MonoTrig	SGL-MLT
8	AD Env Attack	ENV A/D Attack	0...127
9	AD Env Decay	ENV A/D Decay	0...127
10	Audio Input Triggering	ENV Audio Trig	OFF-ON
11	External Audio to Effects	ENV Audio to FX	OFF-ON

Program Level dB (Menu Page 1)

The value of this function adjusts the *program output level*. This is used to maintain a consistent volume level, avoiding distortion throughout all sound Programs. Delicate sounds (such as those which use just one Oscillator and closed filter settings) can be increased in volume using this control. Conversely, sounds that use all Oscillators and high polyphony (6 to 8 notes played at once), can be reduced in volume to avoid distortion. Using a mixing desk as a comparison, this control can be thought of as the *gain* or *trim* control for the channel.

If a sound appears to be distorting unintentionally, especially when complex chords are being played, reduce the value of this setting.

Velocity To Env Level (Menu Pages 2, 3 & 4)

These functions determine how the Amp, Mod and FM Envelopes respond to Velocity information.

Setting up a sound to make it's volume respond to velocity

Select the second Page in the Envelopes Menu (ENV Amp Vel). Adjust the DATA knob. At a setting of zero, a soft key stroke will produce a sound at the same volume as a hard key stroke. At a maximum positive value (63) soft key strokes will be much quieter than hard key strokes. At a maximum negative value (-64), soft key strokes will be much louder than hard key strokes.

Setting up a sound to make its brightness or pitch respond to velocity

Select the third Page in the Envelopes Menu (ENV Mod Vel). Adjust the PERF / PROG / DATA knob. Turn the Filter FREQUENCY knob to a near zero setting or until the sound almost disappears. Turn the MOD ENV DEPTH knob in the Filter section to a maximum clockwise position.

In the Envelopes section, Set the MOD ENV ATTACK and SUSTAIN knob to zero and the DECAY knob to nearly full. While playing notes on the Keyboard, adjust the PERF / PROG / DATA knob. At a setting of zero there will be no effect on the brightness of the sound.

At maximum positive value (63), soft key strokes will produce a tone much softer than hard key strokes. At a maximum negative value (-64), soft key strokes will produce a tone much brighter sound than hard key strokes. To affect the pitch, adjust the MOD ENV knob in the Oscillator section.

Adjusting the Velocity Response of the AD Envelope

Select a factory preset FM sound (such as 209). Select the fourth page in the Envelopes Menu (AD Env modulation). Adjust the PERF / PROG / DATA knob. Notice how the FM effect at the start of the sound becomes dependent on how hard the keys are struck.

Envelope Triggering (Menu Pages 5, 6 & 7)

These functions only apply to a sound which has been set up to behave in a monophonic manner (see **Voice Mode** on Page 34).

When the Voice mode is set to any of the Mono options, different envelope triggering options are available for legato playing styles (notes overlapping).

When the first note of a musical phrase is played, it might be desirable to have both the Amp and Mod envelopes trigger. For the remaining legato notes, just the Mod envelope re-triggering would create the effect of the phrase becoming quieter and quieter.

As well as affecting the two Envelopes available on the front panel, it is possible to set the triggering mode for a third, hidden Envelope termed the AD Envelope. This Envelope has only Attack and Decay stages and is only used for FM synthesis or for modulating the level of Oscillator 3 in the Mixer section.

When these are set to **SGL** (single), the appropriate Envelope will only be triggered when the first keyboard note is played. Any subsequent legato style key presses will not re-trigger the Envelope.

When set to **MLT** (multi), the appropriate Envelope will always re-trigger on each key press, regardless of the playing style used.

AD Env Attack (Menu Page 8)

When FM synthesis is being used (see Page 35) or the Mixer's OSC 3 Level is being modulated, this value determines the AD Envelope's Attack time.

Note : The AD Envelope is used only for FM synthesis or modulating OSC 3's level in the Mixer and should not be confused with the Amp or Mod Envelopes available on the front panel.

AD Env Decay (Menu Page 9)

When FM synthesis is being used (see Page 35) or the Mixer's OSC 3 Level is being modulated, this value determines the AD Envelope's Decay time.

Note : The AD Envelope is used only for FM synthesis or modulating OSC 3's level in the Mixer and should not be confused with the Amp or Mod Envelopes available on the front panel.

Audio Input Triggering (Menu Page 10)

It is possible to process an external audio signal through the Filter and / or Effects section. However, it should be remembered that the Amplifier is controlled by the AMP ENVELOPE controls on the front panel. Unless the Amplifier has been triggered (usually by playing notes on the keyboard or from a sequencer), the Amplifier will be set at a zero volume level and no audio signal will be passed through it.

This is not a problem when the external audio signal is to be passed solely through the Effects Section (since the Effects come after the Amplifier in the audio signal path). However, if it desired to process the external audio signal through the Filter, it is often convenient to be able to automatically trigger the Amplifier and Mod envelopes whenever an external audio signal is present.

Setting this function to **ON** automatically triggers the Amp and Mod Envelopes (thus opening up the Amplifier) whenever the external audio signal strength reaches a certain *threshold* level. This feature ensures that it is not necessary to play a note from the keyboard or a sequencer in order to hear the external audio signal processed through the Filter.

The setting of the threshold level (sensitivity to external audio strength) is done by adjusting the **Input Trigger Sensitivity** value found within the Global Menu. See Page 51 for details.

When the Envelopes are auto-triggered in this way, the KS Rack actually 'plays' a default note of Middle C. If the Mixer levels of any of the three Oscillators are set above zero, a pitched element to the sound will be heard (pitched at Middle C) whenever the Amp Envelope is auto-triggered. To remove this, make sure each of the Oscillator Mix levels in the Mixer Section are set to zero.

See Page 51 for more details of using external audio signals.

The Envelopes Menu

External Audio To Effects (Menu Page 11)

This function determines where the external audio signal is fed into the audio signal path. There are two possibilities.

1. Feeding External Audio Directly To The Effects

The external audio signal may be fed directly to the Effects section, bypassing the Mixer, Filter and Envelopes. Once the input sensitivity has been set for the input device (see Page 51), turn the the PERF / PROG / DATA knob until the display shows **ON**. The external signal should now be heard at the outputs. It may now be processed by all of the various effects including the EQ Filter.

2. Feeding External Audio Through The Filter

Setting this function to **OFF**, feeds the external audio signal into the Mixer and Filter section. In order to hear the filtered signal, repeatedly press the NOISE / RING / EXT button in the Mixer section until the EXT INPUT LED lights and turn up the NOISE / RING / EXT knob. The Amplifier also needs to be triggered by the Amp Envelope. This is done either by playing a note on the keyboard, playing in a MIDI note message from a sequencer, or setting the Amp Envelope to auto-trigger when an external audio signal is present. See the function **Audio Input Triggering** described above for details on how to do this.

Once an external audio signal has passed through the Filter, it can still be processed by the Effects section in the same manner as any other audio source (Oscillator waveforms etc.).

See Page 51 for more details of using external audio signals.

The Effects Menu

To complement the front panel controls in the Effects section, there are many other functions located within the Effects Menu. These are selected by pressing the keypad '6' button when a Menu is selected.

The Effects Menu comprise of seven separate sub-Menus (one for each different type of effect available). The actual sub-Menu accessed will be determined by whichever Effect type is currently selected by the SELECT buttons within the Effects / Arp / Hypersync Section.

In an Effect sub-Menu, it is also possible at any time, to switch instantly to a new sub-Menu relating to a different effect, simply by selecting the effect using the Effects SELECT buttons.

The Delay Menu

The comprehensive Delay effects processor has many programmable functions. These may be edited to create the desired delay effect for a particular sound and saved along with the sound. Use the PERF / PROG / PAGE up/down buttons to scroll through the Menu functions available - See table below.

Delay Menu			
Page	Function	Display	Value
1	Time	DEL Delay Time	0...127
2	Feedback	DEL Feedback	0...127
3	Stereo Width	DEL Stereo Width	0...127
4	Left/Right Time Ratio	DEL L/R Ratio	1/1...O/1
5	Wheel Level	DEL Wheel Send	-64...63

Time (Menu Page 1)

Controls the amount of time it takes for the delayed signal to be heard after the original signal.

Feedback (Menu Page 2)

Controls how much of the delayed signal is fed back into the delay input. No feedback produces a slapback echo effect, just one delayed sound with no repeats. Small amounts of feedback produce repeated sounds resulting in a multiple echo effect. Large amounts of feedback produces infinite echoes.

Stereo Width (Menu Page 3)

This sets the Stereo spread between the long and short Delay times. With a width setting of zero, both delays appear in the middle of the stereo field (Mono). At maximum width setting, the longer delay will appear on one output and the shorter on the other, producing a dramatic stereo effect.

Delay Ratios	
Left/Right	
1/1	
4/3	
3/4	
3/2	
2/3	
2/1	
1/2	
3/1	
1/3	
4/1	
1/4	
1/OFF	
OFF/1	

Left / Right Time Ratio (Menu Page 4)

Automatically adjusts the ratio of the longest delay time and the shorter delay time into timings that are musically useful.

Use the PERF / PROG / DATA knob to select the most suitable ratio. A Simple, equal 1 to 1 ratio is the first entry in the table. This setting sends a delay of equal time to the left and right output channels. The number in the left column of the table indicates the ratio of the delay time that will be in the left channel versus the number in the right column.

For example, if a delay of twice the time is required in the left channel compared to the right, select the **2/1** option. The final **1/OFF** and **OFF/1** options will result in no delay being heard in the channel indicated by the 'OFF'.

Note: Selecting a 1/1 ratio will produce a mono effect regardless of the Stereo width setting since the timing of the echos are equal.

Wheel Level (Menu Page 5)

Sets how much the movement of a Master keyboard's Modulation wheel will introduce the delay effect.

The Reverb Menu

The Reverb Menu

The Reverb Effect is an electronic simulation of a room or building that is acoustically reflective.

When a sound is made in a room or large building, there are sound reflections from all directions. When a Reverb effect is applied, it is these reflections of the sound that are being added.

Use the PERF / PROG / PAGE up/down buttons to scroll through the Menu functions available - See table below.

Reverb Menu			
Page	Function	Display	Value
1	Type	REV Type	CHAMBER...G HALL
2	Decay Time	REV Decay Time	0...127
3	Wheel Level	REV Wheel Send	-64...63

Type (Menu Page 1)

Different types of rooms and halls have different acoustics, therefore different Reverb characteristics. The Reverb processor features six different Reverb types. These range from a small room to a large hall.

Reverb Types	
Display	Function
CHAMBER	Echo Chamber
S ROOM	Small Room
L ROOM	Large Room
S HALL	Small Hall
L HALL	Large Hall
G HALL	Grand Hall

Turn the PERF / PROG / DATA knob to experiment with different types of Reverb, noting how different 'rooms' affect the acoustic properties of the sound.

Decay Time (Menu Page 2)

This is the time it takes for the Reverb to die away after the original sound has decayed. Very acoustically reflective rooms (like those with metal or glass surfaces) tend to have long decay times and non reflective rooms have short ones.

Wheel Level (Menu Page 3)

Sets how much movement of a Master keyboard's Modulation wheel will introduce the Reverb effect.

The Chorus Menu

This effect was originally designed to simulate the sound of many people singing together (hence the name Chorus) in contrast to a single voice. Instrumentally, consider the sound of a 12 string guitar compared to a 6 string guitar. The very slight detuning of the individual strings actually gives a richer quality to the sound.

Chorus is an effect produced by mixing a continuously delayed version of the audio signal back with the original. The timing of the delayed version is very small and is controlled by the Chorus's own internal LFO (not to be confused with the two LFOs available on the front panel). The characteristic swirling Chorus effect is the result.

The Chorus is also capable of behaving as a Phaser. The way a Phaser works is in fact entirely different to the Chorus. A portion of the audio signal is split off and phase shifted at certain frequencies. It is then mixed back with the original signal to generate the characteristic swishing effect.

The functions available in the Chorus Menu are :

Chorus Menu			
Page	Function	Display	Value
1	Type	CHOR Type	CHORUS-PHASER
2	Rate	CHOR Mod Rate	0...127
3	Mod Depth	CHOR Mod Depth	0...127
4	Mod Centre	CHOR Centre Posn	-64...63
5	Feedback	CHOR Feedback	-64...63
6	LFO Sync Initial Position	CHOR Init Posn	OFF...RGT
7	Wheel Level	CHOR Wheel Level	-64...63

Type (Menu Page 1)

Determines whether the Chorus is behaving as a standard Chorus or as a Phaser.

Rate (Menu Page 2)

Controls how fast the dedicated Chorus LFO is oscillating. A fairly slow speed is recommended. Higher speeds tend to introduce a vibrato like quality to the sound.

Note : The dedicated Chorus LFO should not be confused with the two LFOs available on the front panel.

Mod Depth (Menu Page 3)

The Chorus has its own LFO which is continuously changing the delay time. **Mod Depth** sets how much of the fixed delay time is being modulated. Large amounts of modulation will produce a more noticeable effect. Moderate amounts are recommended.

Note : The dedicated Chorus LFO should not be confused with the two LFOs available on the front panel.

Mod Centre (Menu Page 4)

The Stereo Chorus can actually be thought of as two continuously variable delays. The delay variations are being controlled by the Chorus dedicated LFO. The LFO is constantly moving the two delay amounts from minimum to maximum. When one delay is at max, the other is at min (hence the stereo effect).

The **Mod Centre** function moves the middle point between the Min and Max values. Experiment with this control for the desired effect.

Feedback (Menu Page 5)

This function controls how much of the delayed signal is fed back to the input of the Chorus generator. The Chorus effect benefits from low levels of feedback. When acting as a Phaser (see the Chorus **Type** setting on Page 29), the effect often requires higher levels of feedback.

LFO Sync Initial Position (Menu Page 6)

As well as being able to synchronize to MIDI clock (tempo), the dedicated Chorus LFO may have its initial position set after a specific MIDI event is received (see the **Global Sync Mode** function on Page 51).

Chorus LFO Sync Initial Pos	
Display	Function
OFF	Off
LFT	Left
MID	Centre
RGT	Right

The initial positions available are shown in the table above. For example, if the Chorus initial position sync is set to **RGT**, after an appropriate MIDI event, the Chorus effect will move from the right to the left.

Wheel Level (Menu Page 7)

This sets how much movement of a Master keyboard's Modulation wheel will introduce the Chorus effect.

The Distortion Menu

The Distortion Menu

Distortion is an effect commonly used by Guitar players. However, it is now increasingly used in the production of modern Dance music. The Distortion effect gives the sound a hard edged, distorted and dirty kind of quality. Use the PERF / PROG / PAGE up/down buttons to scroll through the Menu functions available - See table below.

Distortion Menu			
Page	Function	Display	Value
1	Level Compensation	DIST Level Comp	0...127
2	Wheel Level	DIST Wheel Level	-64...63

Level Compensation (Menu Page 1)

If distortion is added to a sound, it will tend to get louder. In order to contain or compress the sound back to a level which is consistent with other programs, use this function which compensates for the perceived added loudness of a sound when Distortion is added.

Wheel Level (Menu Page 2)

This function determines how much movement of a Master keyboard's Modulation wheel will introduce the Distortion effect.

The EQ Menu

Contained in the Effects section is an EQ (Equalisation) Filter which can boost or cut high (treble) or low (bass) frequencies in a similar manner to the 'tone' controls often found on domestic hi-fi units.

As well as being able to boost low or high frequencies, the final output EQ Filter may be used to create automatic sweeps of EQ and filtering. EQ processing may be synchronized to tempo and locked to musical timings from 32nd triplets through to several bars.

Use the PERF / PROG / PAGE up/down buttons to scroll through the Menu functions available - See table below.

Page	Function	Display	Value
1	Frequency	EQ Frequency	0...127
2	Mod Depth	EQ FreqMod Depth	0...127
3	Mod Rate	EQ FreqMod Rate	0...127
4	LFO Sync Initial Position	EQ Init Position	OFF...HI

Frequency (Menu Page 1)

The EQ frequency set point determines where in the sound spectrum the boost or cut occurs. The **Frequency** point may be moved anywhere from very low frequencies (0 = less than 10Hz) to very high frequencies (127 = above 20,000Hz)

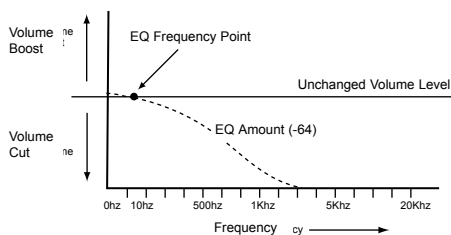

EQ Frequency set to 5

To change the EQ frequency, select Page 1 in the EQ Menu. Adjust the

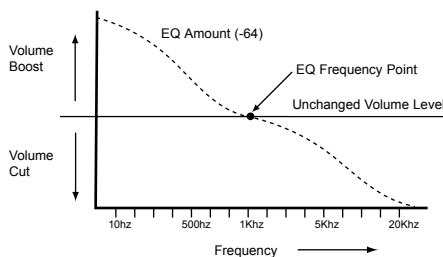

EQ Frequency set to 50

DATA knob for the desired EQ frequency.

Mod Depth (Menu Page 2)

The real power of the EQ filter is the ability to move the EQ **Frequency** set point automatically with the dedicated LFO. This control dictates how intense the movements are from the LFO. Any amount of depth will result in EQ changes at the rate determined by the EQ rate control.

Note : The dedicated EQ LFO should not be confused with the two LFOs available on the front panel.

To change the depth, select Page 2 in the EQ Menu. Adjust the DATA knob for the desired EQ Depth.

Mod Rate (Menu Page 3)

Determines the rate (speed) of the dedicated EQ LFO. This LFO is able to modulate the EQ frequency (see **Mod Depth** above). To change the rate, select Page 3 in the EQ Menu. Rotate the DATA knob clockwise to increase the rate and anticlockwise to decrease the rate.

Note : The dedicated EQ LFO should not be confused with the two LFOs available on the front panel.

LFO Sync Initial Position (Menu Page 4)

As well as being able to synchronize to MIDI clock (tempo), the dedicated LFO used to modulate the depth of the EQ may have its initial position set after a specific MIDI event is received (such as Program Change or Start Song - see the **Global Sync Mode** function on Page 51).

To change the EQ Initial position, select Page 5 in the EQ Menu. Use the PERF / PROG / DATA knob to select one of the initial positions shown in the table below.

Display	Function
OFF	Off
LOW	Low Freq
MID	Centre Freq
HI	High Freq

For example, if the desired position is to start moving upwards then set this function to **LOW**. After an appropriate MIDI event, the LFO wave will start to climb from this low position. Set to **MID** and it climbs from the centre of the waveform.

Note : The dedicated EQ LFO should not be confused with the two LFOs available on the front panel.

Setting The EQ Amount

Setting of the EQ cut / boost amount at the EQ **Frequency** position is done by altering the EFFECTS LEVEL knob in the Effects / Arpeggiator / Hypersync section of the front panel. See Page 28.

The Panning Menu - The Vocoder Menu

The Panning Menu

The Panning function performs the same function as the Panning knob on a mixing console. It can be used to position a sound anywhere from left to right in the stereo field.

Changing the Pan Position of a sound

Ensure that Panning is selected by the SELECT buttons in the Effects section. Turn the Effects section EFFECTS LEVEL knob clockwise or anticlockwise to move the sound across the Stereo field.

Use the PERF / PROG / PAGE up/down buttons to scroll through the Menu functions available - See table below.

Pan Menu			
Page	Function	Display	Value
1	Stereo Pan Position	Pan Position	-64...63
2	Rate	PAN Mod Rate	0...127
3	LFO Sync Initial Position	PAN Init Posn	OFF...RGT

Manual Pan Position (Menu Page 1)

The position of the sound across the Stereo Left to Right field may be set using this page.

A value of -64 moves the sound to the far left and a value of +63 moves the sound to the far right.

Rate (Menu Page 2)

This function controls the Panning LFO's speed. If the **Mod Depth** is set to a non zero value, the Panning LFO will move the sound from the Left to the Right at a speed determined by this **Rate** setting

Note : The Panning LFO should not be confused with the two LFOs available on the front panel.

LFO Sync Initial Position (Menu Page 3)

As well as being able to be synchronized to a MIDI clock (tempo), the Panning LFO may have its initial position set after a specific MIDI event is received (see the **Global Sync Mode** function on Page 51).

The initial positions are shown in the table above. For example, if the Panning initial position sync is set to **RGT** (Right), after an appropriate MIDI event has been received, the sound will begin in the right output audio channel and then move towards the left.

Pan LFO Sync Initial Position	
Display	Function
OFF	Off
LFT	Left
MID	Centre
RGT	Right

Note : The Panning LFO should not be confused with the two LFOs available on the front panel.

The Vocoder Menu

Vocoder sounds have recently returned to popularity and are being used more frequently in modern Pop and Dance music, typically to produce distinctive 'robot voice' type effects.

Activating The Vocoder

This is done by using the EFFECTS LEVEL knob found in the Effects section while the Vocoder is currently selected by the SELECT buttons. This control is also used to balance the various elements used to create the Vocoder effect. See Page 28 in the **Main Features and Operation** section for full details and for a description of how the Vocoder operates.

Additional functions relating to the Vocoder are to be found in the Vocoder Menu. Use the PERF / PROG PAGE up/down buttons to scroll through the Menu functions available - See table below.

Vocoder Menu			
Page	Function	Display	Value
1	Stereo Width	VOC Stereo Width	0...127
2	Sibilance Level	VOC Sibil Level	0...127
3	SibilanceType	VOC Sibil Type	HP-Noi

Stereo Width (Menu Page 1)

Determines how wide the stereo output of the vocoder will be. The bands of the Vocoder are panned one by one to the left and to the right. Increasing the value moves the individual bands further away from the centre position.

Sibilance Level (Menu Page 2)

Determines the amount of sibilance there will be present in the final vocoded signal. Typically these are the 'S' and 'T' types of sounds heard in speech. Adding sibilance gives the Vocoder a more defined sound and helps make vocoded voices more intelligible.

Sibilance Type (Menu Page 3)

Determines if the vocoder uses real sibilance high-pass filtered from the modulator or artificially generates it using noise. When set to **HP**, a high pass filter is used to extract the sibilance from the modulator (Note : this will allow some of the modulator signal to be heard). When set to **NOI**, Noise is used to artificially generate the sibilance.

The Wheels Menu

This menu controls how the much response there is to Pitch and Modulation from the pitch and mod wheels on a Master keyboard.

It is selected by pressing the keypad '7' button when the menu buttons is active. Use the PERF / PROG / PAGE up/down buttons to scroll through the Menu functions available - See table below.

Wheels Menu			
Page	Function	Display	Value
1	Osc 1 Pitch Bend Semitones	BW Osc1 Bend	-12...12
2	Osc 2 Pitch Bend Semitones	BW Osc2 Bend	-12...12
3	Osc 3 Pitch Bend Semitones	BW Osc3 Bend	-12...12
4	Osc 1,2,3 Pitch Shift in Semitones	MW Pitch Direct	-64...63
5	Osc 1,2,3 Pitch Mod (LFO1)	MW Pitch Mod	-64...63
6	Filter Frequency Shift	MW Filter Freq	-64...63
7	Filter Frequency Mod (LFO2)	MW Filt Freq Mod	-64...63
8	Amplifier Gain (post-distortion)	MW Output Level	-64...63

Control of Main Volume from the Modulation Wheel (Menu Page 8)

By routing the Modulation wheel to the amplifier, the overall volume of the sound may be controlled. Positive values of 1 to 63 increase the output volume of the Amp Envelope as the Modulation Wheel is pushed forwards. Negative values from -1 to -64 decrease the output volume of the Amp Envelope as the Modulation Wheel is pushed forwards. At a setting of 0, the wheel will have no effect.

Oscillator 1,2 and 3 Pitch Bend Amount (Menu Page 1,2 and 3)

This setting is used to shift the absolute pitch of the Oscillators up or down in response to the Pitch (left hand) Wheel position. Values 1 to 12 will result in a higher pitch from 1 to 12 semitones when the wheel is pushed forward. Display values -1 to -12 will result in a lower pitch.

NOTE: If the current program uses more than one Oscillator, it is recommended that the bend amount is set equal for each Oscillator. If chord type effects are required when moving the pitch wheel, different pitch bend amounts may be set for each Oscillator.

Modulation Wheel Pitch shift in Semitones (Menu Page 4)

It may be desirable to drastically change the pitch of all the Oscillators using the Modulation Wheel. This setting is used to shift the absolute pitch of the all the Oscillators up or down in response to the Modulation (right hand) Wheel position. Values 1 to 63 will result in a higher pitch from 1 to 63 semitones when the wheel is pushed forward. Values -1 to -64 will result in a lower pitch.

Oscillator 1, 2 and 3 Pitch Modulation from LFO 1 (Menu Page 5)

Enables LFO 1 to modulate the pitch of the Oscillators, introducing a vibrato effect. As the Modulation Wheel is pushed forwards LFO 1 modulation will be applied. As the Modulation wheel is pulled back the amount of LFO 1 modulation to the Oscillators pitch will decrease.

Adjust this value to set the depth of pitch modulation applied by LFO 1.

For best results, ensure that LFO 1 is using a Triangle waveform. This will give a smooth, traditional vibrato effect.

Opening or Closing the Filter using the Modulation Wheel (Menu Page 6)

The filter Cut off frequency may be raised (opening the filter) or lowered (closing the filter) directly from the modulation wheel using this menu option.

Positive values from 1 to 63 will open the Filter when the wheel is pushed forward. A negative values from -1 to -64 will close the Filter when the wheel is pushed forward.

Filter Frequency Modulation from LFO 2 using the Modulation Wheel (Menu Page 7)

Enables LFO 2 to modulate the Cutoff FREQUENCY of the Filter,. The popular 'wow-wow' effect will be heard if LFO 2 waveform is set to Triangle.

A positive value 1 to 63 will open the filter in time with LFO 2 above the basic Cut off frequency. A negative value -1 to -64 will close the filter in time with LFO 2 below the basic Cut off frequency.

Using a high value and setting LFO 2 to different waveforms will introduce dramatic effects when moving the modulation wheel.

The Aftertouch and Breath Menu

The Aftertouch and Breath Menu

This menu controls how response there is to Aftertouch and Breath Control (CC2) MIDI messages.

It is selected by pressing the keypad '8' button when the Menu button is active. Use the PERF / PROG / PAGE up/down buttons to scroll through the Menu functions available - See table below.

Aftertouch / Breath Menu			
Page	Function	Display	Value
1	Atouch: Osc 1,2,3 Pitch Shift	AT Pitch Direct	-64...63
2	Atouch: Osc 1,2,3 Pitch Mod (lfo1)	AT Pitch Mod	-64...63
3	Atouch: Filter Frequency Shift	AT Filter Freq	-64...63
4	Atouch: Filter Frequency Mod (lfo2)	AT Filt Freq Mod	-64...63
5	Atouch: Amp Gain (post-distortion)	AT Output Level	-64...63
6	Breath: Osc 1,2,3 Pitch Shift	BR Pitch Direct	-64...63
7	Breath: Osc 1,2,3 Pitch Mod (lfo1)	BR Pitch Mod	-64...63
8	Breath: Filter Frequency Shift	BR Filter Freq	-64...63
9	Breath: Filter Frequency Mod (lfo2)	BR Filt Freq Mod	-64...63
10	Breath: Amp Gain (post-distortion)	BR Output Level	-64...63

Ensure that any connected MIDI device is configured to transmit Aftertouch or Breath Control MIDI data (if in doubt, consult the device's manual for details).

In order to hear the effect of any of these settings, press a key on the connected keyboard or blow into the breath controller while adjusting the values.

All Aftertouch settings will respond to the Aftertouch generated by playing the keyboard.

Atouch : Osc 1, 2, 3 Pitch Shift (Menu Page 1)

This setting is used to shift the absolute pitch of the Oscillators up or down in response to incoming Aftertouch data.

Set in the range **-64** to **-1**, and any Aftertouch data will shift the pitch of the Oscillators downwards. With a range of **1** to **63**, any Aftertouch data received will shift the pitch of the Oscillators upwards. Greater values increase the amount of pitch shifting applied.

At a setting of **0**, Aftertouch messages will have no effect.

Atouch : Osc 1, 2, 3 Pitch Mod (LFO 1) (Menu Page 2)

Enables LFO 1 to modulate the pitch of the Oscillators, introducing a vibrato effect. As Aftertouch messages are received, the LFO 1 modulation will be applied. As the Aftertouch data falls back towards zero, the amount of LFO 1 modulation to the Oscillators pitch will also decrease.

Adjust this value to set the depth of pitch modulation applied by LFO 1. At a setting of **0**, Aftertouch messages will have no effect.

For best results, ensure that LFO 1 is using a Triangle or Sine waveform. This will give a smooth, traditional vibrato effect.

Atouch : Filter Frequency Shift (Menu Page 3)

This setting is used to modulate the Cutoff FREQUENCY of the Filter up or down in response to incoming Aftertouch data.

Set in the range **-1** to **-64**, the Filter will close (the Cutoff FREQUENCY will decrease) as Aftertouch data is applied. With a range of **1** to **63**, the Filter will open (the Cutoff FREQUENCY will increase) as Aftertouch data is applied. Greater values will open (increase the Cutoff FREQUENCY) as Aftertouch data is received. At a setting of **0**, Aftertouch messages will have no effect.

Atouch : Filter Frequency Mod (LFO 2) (Menu Page 4)

Enables LFO 2 to modulate the Cutoff FREQUENCY of the Filter, introducing a 'wow-wow' effect. As Aftertouch messages are received, the LFO 2 modulation will be applied. As the Aftertouch data falls back towards zero, the amount of LFO 2 modulation to the Filter Cutoff FREQUENCY will also decrease.

Adjust this to set the depth of modulation applied by LFO 2. At a setting of **0**, Aftertouch messages will have no effect.

For best results, ensure that LFO 2 is using a Triangle or Sine waveform. This will give a smooth, traditional 'wow-wow' effect.

Atouch : Amp Gain (post - distortion) (Menu Page 5)

Allows Aftertouch messages to directly alter the Amplifier level, allowing the overall volume of a sound to be altered.

Positive values of (**1** to **63**) increase the output volume of the Amp Envelope as Aftertouch is applied. Negative values (**-1** to **-64**) decrease the output volume of the Amp Envelope as Aftertouch is applied. At a setting of **0**, Aftertouch messages will have no effect.

Routing Breath Control (Menu Pages 6 - 10)

It is also possible to use incoming Breath Control MIDI messages to affect and modulate sounds. The principle of using Breath Control is exactly the same as the way in which Aftertouch is applied.

The remaining five pages in the menu offer exactly the same features and routings as are available for Aftertouch, but these settings apply to Breath Control information.

The Utilities Menu

This menu contains various utility functions associated with dumping data via MIDI, restoring memories and wheel calibration. The Utilities Menu is accessed by pressing the keypad '9' button when the Menu button is active.

Use the PERF / PROG / PAGE up/down buttons to scroll through the Menu functions available - See table below.

Utility Functions Menu			
Page	Function	Display	Value
1	Transmit Midi Sysex Dump	Dump	CURR SOUND-GLOBAL DATA
2	Restore Factory Settings	Restore	ONE PROG-GLOBAL D
3	Display Contrast	Contrast	0...64

Transmit Midi Sysex Dump (Menu Page 1)

MIDI System exclusive messages (often shortened to Sysex) are used to transfer 'dump' a record of the memory contents for storage in an external MIDI device, usually a sequencer. Saving data in this way is useful for building up sound libraries or creating an emergency data backup in case memories are accidentally over-written.

It is possible to link two KS Rack machines directly together with a MIDI cable and use Sysex dumping as a means of directly transferring memory contents from one machine to the other. KS 4 or KS 5 sysex dumps are directly compatible with KS Rack machines and vice versa

To initiate a Sysex dump, select the desired option using the PERF / PROG / DATA knob. Start the sequencer recording and press the WRITE button to start transmission of Sysex data. If the **CURR SOUND** option or **GLOBAL DATA** is selected then the display will flash DONE as confirmation that the transmission has taken place.

Transmit Midi Sysex Dump	
Display	Function
Dump CURRENT SOUND	Current Sound (including edits)
Dump PROGRAM BANK 1	Program Bank 1
Dump PROGRAM BANK 2	Program Bank 2
Dump PROGRAM BANK 3	Program Bank 3
Dump PROGRAM BANK 4	Program Bank 4
Dump DRUM BANK 1	Drum Bank 1
Dump DRUM BANK 2	Drum Bank 2
Dump DRUM BANK 3	Drum Bank 3
Dump DRUM BANK 4	Drum Bank 4
Dump PERFORMANCE BANK 1	Performance Bank 1
Dump All Banks	Total Data in Prog, Perf and Global Banks
Dump GLOBAL DATA	Global Data

If **PROG BANK1** through **PROG BANK 4** is selected the display will indicate progress of transmission by indicating **DUMPING PROG XXX** (where XXX is the Program number).

Note : Some sequencers (such as Cubase) sometimes have Sysex messages filtered out as a default setting. If the sequencer appears not to have recorded the sysex dump into a track, check that the sequencer is not set to filter out Sysex messages. Consult the sequencer's manual for details.

Receiving a Sysex Dump

Once Sysex data has been stored in a sequencer track, the data can then be re-loaded by playing the sequencer track in the normal way.

If a single Sound or Performance is received via Sysex, it is important to realise that it is only *Program / PerformanceEdit Buffer* which has been changed. The newly-received Program or Performance can immediately be played on the keyboard, but if the new Program or Performance is to be kept, it must be saved into a memory location in the normal way, similar to when a Program or Performance has been edited.

When a whole bank of sounds or the Global settings are received via Sysex, the data is placed directly into the memories. For this reason, it is important to make sure that the Global **Memory Protect** switch is set to **OFF** (see Page 50) before loading a whole bank of Programs or Performances or Global data, otherwise the dump will be rejected.

Restore Factory Global Settings (Menu Page 2)

When this option is selected, press the WRITE button to restore all Global Data. The display will flash 'DONE' and **Program Mode** or **Performance t Mode** will be selected.

Note : It is only possible to restore Global Data if the Global **Memory Protect** switch is turned **OFF** (see Page 50).

Important Note : It is not possible to directly restore the factory Programs or Performances using the restore function. In order to do this, go to the website www.novationmusic.com and download the factory presets from the download page.

Display Contrast (Menu Page 3)

Rotate the PERF / PROG / DATA knob to adjust the contrast of the display until it is easy and comfortable to read.

The Global Menu

The Global Menu

This menu is used to change various settings which remain constant regardless of which Program or Performance is currently selected. The Global Menu is selected by pressing the keypad '0' button the MENUS button is selected. Use the PERF / PROG / PAGE up/down buttons to scroll through the Menu functions available - See table below.

Global Menu (not stored in programs)			
Page	Function	Display	Value
1	Memory Protection	Memory Protect	OFF-ON
2	Global MIDI Channel	Global Midi Channel	1...16
3	Master Tune Cents	Master Tune	-64...63
4	Local Control	Local Control	OFF...SEQ
5	Midi Clock Source	Clock Source	INT-EXT
6	Midi Clock Input Status	Ext Clock Status	-- / ON / bpm value
7	Global Sync Mode	Global Sync	NOTE 1...SNG ST
8	Velocity Curve	Velocity Curve	SOFT-HARD
9	Function Display Time*	Display Time	0...127
10	Prog Mode Display Control*	Display Control	TIME-PERM
11	New Menu Always Page 1	New Menu Page	OFF-ON
12	Input Sensitivity Range	Input Sens	LIN-MIC
13	Input Trim dB	Input Trim	-10...20
14	Input Trigger Sensitivity	In Trig Sens	0...127

Memory Protect (Menu Page 1)

This is a safety switch, used to prevent accidental erasure of memories and loss of data. When set to **ON**, writing Programs, Performances or Global data into memory will be prevented, and a brief warning message will be shown on the display.

It is recommended that Memory Protect is left **ON** unless Programs / Performances are being edited for storing into memory, or a System Exclusive dump from a sequencer is to be received.

Permanently saving any changes made to Global settings

Any changes made to the Global settings will remain valid only while the power is on. To permanently save any new settings, the Global Memory must be saved. To do this, press the WRITE button at any time that the Global Menu is active. A message **SAVING GLOBALS** will appear for a short period on the display. Once saved, even if the power is turned off, any new settings will be memorised.

NOTE: After permanently saving the Global settings, the currently selected Program or Performance will be the default Program or Performance after applying power.

MIDI Global Channel (Menu Page 2)

Specifies the MIDI channel on which the KS Rack will transmit and accept MIDI messages from a sequencer or other MIDI device while being used in **Program Mode**.

In **Performance Mode**, the Global MIDI channel is also used to transmit any MIDI messages which are not Part-specific (for example, the TEMPO setting in the Effects / Arpeggiator / Hypersync section). Each Part transmits and receives using its own MIDI channel as defined in the Part Edit Menu (see page 55).

Master Tune Cents (Menu Page 3)

Adjusts the master tuning. At the factory, this value will have been set to **0**. This setting of zero is equivalent to concert pitch tuning (middle C = 440 Hz).

Local Control (Menu Page 4)

This function can be thought of as a switch which when set to **OFF**, disconnects the front panel controls from the internal synthesizer sound engine.

Moving any of the controls still results in the appropriate MIDI information being transmitted from the MIDI OUT socket, but they will have no direct effect on the sound engine. *The sound engine will only be affected if the MIDI signals are routed back into the MIDI IN socket - probably by a sequencer.*

The KS Rack also supports a third, non-standard **Local Control** option - **SEQUENCER**. In this mode, the front panel controls affect the synth engine directly but do NOT transmit MIDI information. This mode can be useful when Parts are being controlled by a sequencer.

It is recommended that **Local Control** is set to **ON** unless the full MIDI implications are appreciated of having it set otherwise. Please see Page 17 in the **MIDI and Sequencers** chapter the **MIDI Tutorial** section of this manual for more details.

MIDI Clock Source (Menu Page 5)

A master timing clock is required in order to determine the tempo (rate) of the arpeggiator and to provide a time base for synchronization to other musical timings. This clock may be derived internally or received from an external device that is able to send a master timing clock (This is often known as a MIDI clock).

This setting determines whether the tempo synchronised features (Arpeggiator, Chorus Sync, EQ Sync, Delay Sync & Panning Sync) will follow the tempo of an external sequencer (external clock) or follow the tempo set by the TEMPO knob found in the Effects / Arp / Hypersync section (external clock).

When set to **EXT**, external clock synchronisation is being used and the temp will be calculated from MIDI Clock messages received from a sequencer. Make sure the external sequencer is set to transmit MIDI Clock. Consult the sequencer manual for details.

Note : Most sequencers do not transmit MIDI Clock while they are stopped. Synchronization to MIDI Clock will only be possible while the sequencer is actually recording or playing.

When set to **INT**, an internal clock is used for synchronisation purposes. The tempo of the internal clock is controlled by the TEMPO knob found in the Effects / Arp / Hypersync section.

MIDI Clock Input Status (Menu Page 6)

Sometimes it is desirable to monitor whether a sequencer is actually transmitting MIDI Clock information. This is especially useful for troubleshooting if **MIDI Clock Source** is set to **EXT**.

To see if an external device is sending a MIDI clock, select this Menu Page. If an external clock is being received, the display will indicate the tempo of the external clock. If not -- will be displayed. If **ON** is displayed, synchronisation to the internal clock is being used.

Global Sync Mode (Menu Page 7)

If **MIDI Clock Source** is set to **EXT** (external clock), a clock synchronization type may be selected using this function This allows the *first note played after all notes have been released or the first note played after a MIDI Program Change or MIDI Start Song Message* to synchronize the Panning, EQ Filter and Chorus LFOs as described on pages 43, 45, and 46. This allows them to have their start position locked in time with the musical piece for stunning effects.

Velocity Curve (Menu Page 8)

The response to MIDI velocity information from an external device such as a MIDI controller keyboard or a sequencer may be set using this function.

A setting of **SOFT** indicates that smaller changes in velocity (a lighter playing style) will create a large change in response to velocity, be it volume or any other modulation destination that velocity is routed to.

A setting of **HARD** indicates that higher changes in velocity - a much harder playing style, will create large changes in response to velocity.

Function Display Time (Menu Page 9)

In Normal operation, whenever a Menu is selected, the display will show the current page within the currently selected menu. If a knob is moved on the front panel, the display will momentarily switch to show the moved knob's value. After a while, the display reverts to showing the menu page previously displayed.

Use this function to adjust the amount of time these temporary messages are displayed on the screen before reverting back to the previous display. Short values give a very brief display period. Longer values increase the display time. A setting of **0** will inhibit the temporary messages being displayed altogether.

Prog Mode Display Control (Menu Page 10)

This function applies a Menu is *NOT* selected. It determines how the display will function when a front panel control is altered.

When set to **TIME**, the display reverts back to Program Select Mode or Performance Select Mode after a short period of time (determined by the Global **Function Display Time** setting as described above).

Set to **PERM**, when a front panel control is moved, the display will continue to show the edited values of the controls until another the PROG, PERF or any MENUS buttons are selected.

New Menu Always Page 1 (Menu Page 11)

All display menus (including this Global one) can operate in one of two different modes. The first mode (factory default setting) specifies that each time a new menu key is pressed, the *first Page in the menu list is always selected*. For example, pressing the keypad button '3' (selecting the Filter Menu) while in Menu Mode will result in always selecting the menu Page showing the Filter **Q Normalise** setting.

The second mode specifies that the *last accessed Page in the menu list is selected the next time that menu is accessed*. For example, if the Filter **Overdrive** setting is being adjusted (Filter menu Page 2), if a different menu is now selected (for example, the Oscillators Menu) and the Filter menu is subsequently selected again, the menu page showing the **Overdrive** setting would be displayed again.

Select **OFF** for the last accessed menu page to be remembered when a menu is selected and **ON** for a newly selected menu to always display the first page in its menu list.

Using the External Audio Input

In order to use an external audio input, the KS Rack must be set up to correctly to respond to the level (amplitude) of the incoming signal. Since the levels of these signals can vary substantially, the Global menu functions **Input Sensitivity Range** and **Input Trim dB** (detailed below) must be adjusted for optimum performance. This will minimize signal distortion and noise.

Input Sensitivity Range (Menu Page 12)

Connect the input device to the front panel jack labeled AUDIO INPUT. When connecting devices such as CD players, Turntables, Mixing desks or other line level equipment, set the **Input Sensitivity Range** to **LINE**.

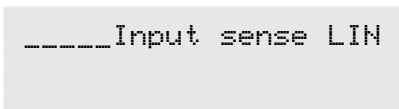

Set this to **MIC** for low level devices such as Guitars or Microphones. Once set, play (or talk into the microphone) the input device.

The first five character blocks (forming a horizontal bar) to the left of the top line of the display will illuminate according to the level of the signal. It is likely that they will all illuminate, or just the lowest one or two to the left. The **Input Trim dB** function must now be used to optimize performance.

Input Trim dB (Menu Page 13)

After **Input Sensitivity Range** has been set, the sensitivity must be 'trimmed' for best performance. Whilst the input signal is present, adjust this value using the PERF / PROG / DATA knob until the the first four blocks on the top line of the display are fully lit and the fifth block lights occasionally as shown in the illustration below.

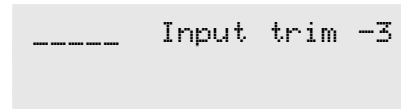

The sensitivity level is now set correctly. In order to hear the external signal through the effects processor or to make the signal trigger sounds, the current PROGRAM selected has to have external audio enabled. This is done from within the Envelopes Menu (see the **Audio Input Triggering** and **External Audio To Effects** functions on Pages 39 and 40). **Setting an External Audio Signal to Trigger the Envelopes**

It is possible to make the KS Rack trigger automatically (thus opening the Amplifier and Filter via the Envelopes) whenever an external signal is present. To do this, it is necessary to determine a *threshold* level, where the Envelopes are triggered whenever the signal reaches or passes a certain loudness point. The threshold is set by using the following **Input Trigger Sensitivity** function.

Input Trigger Sensitivity (Menu Page 15)

This function sets the audio input *threshold* level, in other words, how loud the external signal has to be in order to trigger the Envelopes. Low values require a very loud signal to auto-trigger. Higher values progressively enable much quieter signals to trigger the Envelopes.

Note that it is necessary for a Program to have its **Audio Input Triggering** setting (in the Envelopes Menu) switched to **ON** in order for auto-triggering to take place. See Page 39 for details on how to set this.

NOTE: If the external audio signal seems to be distorting when using a microphone or guitar (without the distortion effect turned on) try selecting **LINE** instead of **MIC** using the input sensitivity function.

Experiment with different settings until the external audio signal reliably triggers the sound as required.

Whenever the auto-triggering is used in this way, it actually behaves as if a Middle C note has been played on the keyboard. It may well be necessary to use the Mixer controls to turn down the levels of the Oscillators if a pitched element to the sound is not required. This is especially recommended if it is desired to hear only the external audio signal passed through the Filter.

The Synchronisation Menu

The Synchronisation Menu

This menu gives access to all parameters which may be synchronized to internal or external MIDI Clock. This is selected by pressing the SYNC MENU button located in the Hypersync section. When SYNC MENU button is pressed, the KS Rack immediately enters **Menu Mode** and the LED above the MENUS button lights to confirm this. Use the PERF / PROG / PAGE up/down buttons to scroll through the Menu functions available - See table below.

Sync Menu			
Page	Function	Display	Value
1	Sync Type	SYNC ARP Tempo	32T...1 bar
2	LFO1 Sync Del Time	SYNC LFO1 Del	OFF...12bars
3	LFO1 Sync Speed	SYNC LFO1 Spd	OFF...12bars
4	LFO2 Sync Del Time	SYNC LFO2 Del	OFF...12bars
5	LFO2 Sync Speed	SYNC LFO2 Spd	OFF...12bars
6	Delay Sync time	SYNC DEL Sync	OFF...2 bars
7	Chorus/Phaser Sync Time	SYNC ChorRate	OFF...12bars
8	EQ Filter Sync Time	SYNC EQ Rate	OFF...12bars
9	Panning Sync Time	PAN Rate	OFF...12bars

In all cases, when a feature is synchronized, the tempo is controlled by the Arpeggiator TEMPO knob when **MIDI Clock Source** is set to **INT**, or by the external sequencer's tempo when **MIDI Clock Source** is set to **EXT**. See Page 50 for information on setting the Global **MIDI Clock Source**.

Note ; In **Performance Mode**, there is only one Arpeggiator TEMPO control which is common to all Parts. It is therefore not possible to have different Parts running at different TEMPO speeds.

When controlling any of these features from a sequencer, it is important to ensure that the sequencer is transmitting MIDI Clock messages. Many sequencers do not transmit MIDI Clock messages at all when they are stopped, only when they are recording or playing back. Consult the sequencer manual for details on how to set the sequencer to transmit MIDI Clock.

In all cases, when a features is synchronized to MIDI Clock, its front panel controls (for example LFO SPEED) will have no effect. These controls will only become effective onc the feature's Synchronization rate has been set to **OFF**, when the feature will no longer be affected by incoming MIDI Clock messages or the Arpeggiator's TEMPO knob setting.

With the exception of the Arpeggiator synchronization. All of these sync settings may be stored within a Hypersync template. See pages 29 and 30 for details on using and editing Hypersync templates.

Arp Sync Type (Menu Page 1)

Allows the Arpeggiator to be synchronized with an external sequencer. A range of synchronization values are available :

Arpeggiator Sync to MIDI Clock table		
Display	MIDI Clocks	Synchronised to
OFF	-	Manual Rate
32nd T	2	32nd Triplet
32nd	3	32nd
16th T	4	16th Triplet
16th	6	16th
8th T	8	8th Triplet
16th D	9	16th Dotted
8th	12	8th
4th T	16	4th Triplet
8th D	18	8th Dotted
4th	24	4th
2nd T	32	2nd Triplet
4th D	36	4th Dotted
2nd	48	2nd
1bar T	64	1 Bar Triplet
2nd D	72	2nd Dotted
1 bar	96	1 Bar

LFO 1 and 2 Delay Sync Time (Menu Pages 2 & 4)

Allows either LFO's delay time to be synchronized to internal or external MIDI Clock tempo. The synchronization values available are :

LFO's / Chorus / EQ / Pan Synchronisation to MIDI Clock table					
Display	MIDI Clocks	Sync'd to	Display	MIDI Clocks	Sync'd to
OFF	-	Manual Rate			
32nd T	2	32nd Triplet	1bar D	144	1.5 Bars
32nd	3	32nd	2 bars	192	2 Bars
16th T	4	16th Triplet	4bar T	256	4 Bar Triplet
16th	6	16th	3 bars	288	3 Bars
8th T	8	8th Triplet	5bar T	320	5 Bar Triplet
16th D	9	16th Dotted	4 bars	384	4 Bars
8th	12	8th	3bar D	432	4.5 Bars
4th T	16	4th Triplet	7bar T	448	7 Bar Triplet
8th D	18	8th Dotted	5 bars	480	5 Bars
4th	24	4th	8bar T	512	8 Bar Triplet
2nd T	32	2nd Triplet	6 bars	576	6 Bars
4th D	36	4th Dotted	7 bars	672	7 Bars
2nd	48	2nd	5bar D	720	7.5 Bars
1bar T	64	1 Bar Triplet	8 bars	768	8 Bars
2nd D	72	2nd Dotted	9 bars	864	9 Bars
1 bar	96	1 Bar	7bar D	1008	10.5 Bars

LFO 1 and 2 Sync Speed (Menu Pages 3 & 5)

LFOs may be synchronized to MIDI Clock. As an example, a very pleasing audio effect may be achieved when an LFO is modulating the filter cut off frequency and this is synchronized to the tempo of a musical piece.

The synchronisation value selected is the period taken for the LFO to complete one whole cycle of its waveform.

To synchronize an LFO, alter this value until the desired musical timing is displayed. See the synchronization table given above (for the LFO Delay synchronization) for details on how these settings relate to the MIDI Clock.

Delay Sync Time (Menu Page 6)

Delay Synchronisation to MIDI Clock table		
Display	MIDI Clocks	Synchronised to
OFF	-	Manual Rate
32nd T	2	32nd Triplet
32nd	3	32nd
16th T	4	16th Triplet
16th	6	16th
8th T	8	8th Triplet
16th D	9	16th Dotted
8th	12	8th
4th T	16	4th Triplet
8th D	18	8th Dotted
4th	24	4th
2nd T	32	2nd Triplet
4th D	36	4th Dotted
2nd	48	2nd
1bar T	64	1 Bar Triplet
2nd D	72	2nd Dotted
1 bar	96	1 Bar
2bar T	128	2 Bar Triplet
1bar D	144	1.5 Bars
2 bars	192	2 Bars

Enables the time of the Delay repeats to be synchronized to the tempo of a song. The synchronization rates available for the Delay Effect are : Note: When controlling the Delay **Sync Time** from a sequencer, it is important to ensure that the sequencer is transmitting MIDI Clock messages are a very steady tempo, otherwise 'clicks' in the sound may occur while the Delay Effects re-adjusts its buffer to suit the new tempo rate.

Chorus Sync Rate (Menu Page 7)

Similar to Delay Sync, the Chorus internal LFO may be synchronized to internal or external MIDI clock tempo.

The available Sync resolutions are the same as those available for the LFO Delay time. These are given in the table on page 52.

EQ Filter Sync Mod Time (Menu Page 8)

The rate (speed) of the dedicated EQ LFO may be locked to the tempo of the musical piece to allow auto EQ Filtering effects. The synchronization table given on page 52 for the LFO Delay time describes the musical timings available for the EQ Filter.

Pan Sync Rate (Menu Page 9)

A very pleasing audio effect may be heard when the Panning effect is synchronized to the tempo of a musical piece. The synchronization table given on page 52 for the LFO Delay time describes the musical timings available for the Pan

The Arpeggiator Menu

To complement the front panel controls in the Arpeggiator section, there are many other functions located in the Arpeggiator Menu. This is selected by pressing the ARP MENU button located in the Arpeggiator section.

When ARP MENU is pressed, the LED above the MENUS button lights to confirm this. Use the PERF / PROG / PAGE up/down buttons to scroll through the Menu functions available - See table below.

Arpeggiator Menu			
Page	Function	Display	Value
1	Mode	ARP Mode	UP ... CHORD
2	Octave Range	ARP Octaves	1...4
3	Pattern	Pattern	OFF - 1 - 32
4	Pattern Velocity On - Off	Pattern	On - OFF
5	Gate Time	ARP Gate Tim	0...127
6	Keysync	ARP Keysync	OFF-ON
7	Arp Note Destination	ARP Notes	INT- EXT- I + E

Mode (Menu Page 1)

This determines the Arpeggio mode used by the Arpeggiator. There are eight types of mode available :

Up

Arp Mode	
Display	Function
UP	Up
DN	Down
UD1	Up/Down
UD2	Up/Down - end repeat
ORD	Order Played
RND	Random
CHORD	Chord
DRUM	Drum sequence

The arpeggio starts at the lowest note played and sweeps up through the notes until it reaches the highest note. It then starts at the bottom again and repeats the sequence.

Down

The arpeggio starts at the highest note played and sweeps down through the notes until it reaches the lowest note. It then starts at the top again and repeats the sequence.

Up/Down

The arpeggio starts at the lowest note played and sweeps up through the notes until it reaches the highest note. It then sweeps back down. This is useful when playing three notes in songs with a 3/4 time signature.

Up/Down - end repeat

The arpeggio starts at the lowest note played, plays it twice, and sweeps up through the notes until it reaches the highest note. It then plays the top note again and sweeps back down.

Order Played

The arpeggio plays the notes in the order they were played on the keyboard. Once at the end of the notes played it repeats the sequence.

Random

Notes played will be arpeggiated in a random order.

Chord

All notes held on the keyboard are played simultaneously.

The Arpeggiator Menu

Drum Sequence

This mode is designed for use with Drum Maps and when applied, supplies a rhythmic drum sequence, instead of a standard Arpeggiator pattern. This is similar in effect to using a preset drum machine. When this mode is selected, the **Pattern** parameter (see below) supplies one of 33 different drum sequences to be applied to the Drum Map.

Octave Range (Menu Page 2)

Sets how many octaves the Arpeggio pattern will sweep through. The sweep range is selectable from 1 to 4 octaves.

Pattern (Menu Page 3)

Normally allows various rhythmic patterns to be applied to the Arpeggiator modes. 32 different patterns are available. Experiment with different patterns numbers to achieve the desired rhythm. When set to **OFF**, each note played has an equal duration.

If the **Mode** parameter on page 1 of the Arpeggiator Menu is set to **Drum**, this parameter instead, selects one of the 33 available drum sequences to be applied. The sequenced drum patterns available are detailed in the following table

Drum Patterns		
Pattern	Name	Bar Length
1	Ballad1	2
2	Ballad2	2
3	BossNova	1
4	Break	2
5	Bungle	2
6	Dynamo	4
7	Electro	2
8	SloGruve	2
9	Funk	2
10	Garage1	2
11	Garage2	2
12	Garage3	2
13	Groove80	2
14	Hat	2
16	Drums	8
16	Drums	2
17	House3	4
18	IndaLoop	2
19	Kick	2
20	Musesick	8
21	Oh808oh	2
22	PastLife	2
23	Pop	1
24	Regal	2
25	Reggae	2
26	Ronnie	1
27	Ruler	2
28	SloBreak	2
29	Smacked	2
30	Snare	2
31	Trance	2
32	Umm	8
33	KicknHat	2

While a Drum pattern is playing. The Part EDIT button blinks to indicate the start of the pattern as it loops around.

Note : When Drum sequences are being used, the **Arp Sync Type** parameter found in the Synchronisation Menu (see page 52) has no effect on the drum pattern being played. Similarly, the **Octave Range**, **Pattern Velocity** and **Gate Time** parameters in the Arpeggiator Menu also have no effect.

Pattern Velocity (Menu Page 4)

When set to **ON**, the note velocities for each note played by the Arpeggiator will be preset values. When set to **OFF**, the note velocities used when playing the keyboard notes are used by the Arpeggiator.

Gate Time (Menu Page 5)

Sets the gate time or duration of the notes being played by the Arpeggiator. Small values of gate time produce a Staccato effect. Large values produce a Legato effect. Anticlockwise and the gate time is very short, clockwise and the gate time is long.

Keysync (Menu Page 6)

When activated, the arpeggio pattern will re-start whenever a new note is played on the keyboard.

Arp Note Destination (Menu Page 7)

For flexibility, the Arpeggiator output may be routed to a number of destinations. Setting the Arp destination to **INT** routes the Arpeggiated notes to the internal sound engine. This could be considered as the normal mode of operation. Only notes played on the keyboard to generate the Arpeggio are transmitted as MIDI note on/off messages.

Setting the destination to **EXT** will route the **ONLY** the notes played by the Arpeggiator to the MIDI output socket (transmitted as MIDI note on/off information).

Setting the destination to **I + E** (internal and external) will route Arpeggiated notes to *both* the MIDI output socket and the internal sound engine. As with the **EXT** option, it is the notes generated by the Arpeggiator which are transmitted via MIDI.

The Part Edit Menu

For versatility, when a program is selected to play on a Part, other information is necessary, such as the MIDI channel it is playing on, the physical output audio jack on the rear panel that is being used etc. etc.

In the example illustration, on Part 1, as well as having the Bass Guitar Program (sound), the MIDI channel is set to 1, the Outputs are set to 1 & 2, the volume is set to 99 and the tuning offsets have values. To change these values, the Part Edit Menu is used.

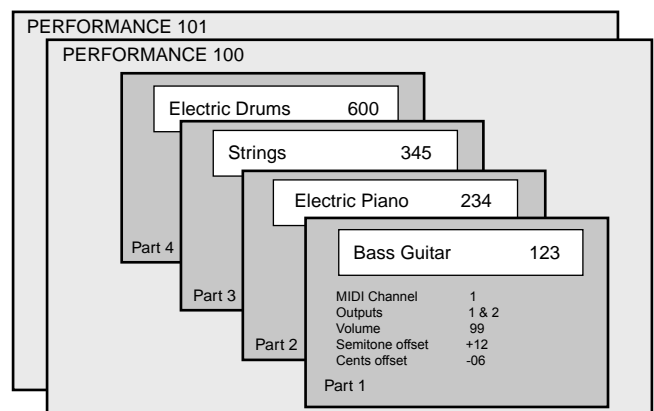

Press the Part MENU button and the LED above the MENUS button will light. Use the PERF / PROG / PAGE up/down buttons to scroll through the Menu functions available - See table below.

In **Program Mode**, it is still possible to access this Menu and make the

Part Edit Menu			
Page	Function	Display	Value
1	MIDI Channel	PART Midi Chan	1 - 16
2	Lowest Note	PART Low Note	C-2 ... G8
3	Highest Note	PART High Note	C-2 ... G8
4	Semitone Detune	PART Semi Offset	-24 ... +24
5	Cents Detune	PART Cent Offset	-64 ... +63
6	Keyboard Velocity Curve	PART Velocity	0.. 127
7	Audio Output Used	PART Output	1 & 2 ... 3 & 4, 1,2,3,4
8	Pedal Options	PART Pedal	Controllers * See text
9	Footswitch Options	PART FootSw	Sustain.. Arp On/Off

settings apply to the sound when played in **Program Mode**. Since only one sound may be played in Program mode, only Part 1 is permanently selected for editing.

MIDI Channel (Menu Page 1)

This sets the MIDI channel used by the Part for transmission and reception.

In **Program Mode**, the **Global MIDI Channel** as set in the Global Menu (see page 50), is used for transmission and reception of MIDI.

If the machine is in **Program Mode** when this Menu is activated, it is not possible to change the MIDI channel here since the Global MIDI channel is used in this mode.

In **Performance Mode**, the MIDI channel used for the each Part may be set using this Menu option. It is possible to set the same MIDI channel on each part. This would be the case when playing sounds that are layered one on top of the other.

Lowest Note (Menu Page 2)

Sets the lowest note on the keyboard which will trigger the Part. Any incoming MIDI notes below this **Lowest Note** will not trigger Part and it will not sound.

If it is desired for the Part to be played over the entire MIDI note range, set this value to the lowest possible setting. Any other setting allows keyboard splits to be achieved from within a Performance.

Highest Note (Menu Page 3)

Sets the Highest note on the keyboard which will trigger the Part. Any incoming MIDI notes above this Highest will not trigger Part and it will not sound.

If it is desired for the Part to be played over the entire MIDI note range, set this value to the Highest possible setting. Any other setting allows keyboard splits to be achieved from within a Performance.

Semitone Detune (Menu Page 4)

Allows the tuning of the Part to be shifted by up to 24 semitones (two octaves) in a positive or negative direction.

This semitone detuning is in addition to any semitone tuning offsets defined for the Oscillators by the SEMITONE knob in the Oscillator section.

Cents Detune (Menu Page 5)

Allows the fine tuning of the whole Program / Part to be shifted by up to -64 or +63 cents.

This fine detuning is in addition to any fine tuning offsets defined for the Oscillators by the DETUNE knob in the Oscillator Section.

Velocity Curve (Menu Page 6)

This option allows the parts to respond in different ways to how hard a key is pressed on the keyboard or from an incoming MIDI note-on message. In the 'Normal' position the Program plays in a normal velocity sensitive way. In the 'Inverse' position the response is inverse to the normal velocity curve - Louder sounds are produced by playing softly rather than hard.

This feature allows a velocity cross fade between two or more sounds on a part to be created. The CROSS FADE - LOW and CROSS FADE - HIGH options are similar but provide a normal response when used together in two different parts. The remaining options provide normal velocity curve responses - 'UP TO' or 'FROM' specific Velocity values. This enables 'Velocity Switch' arrangements to be made by setting up appropriate curves on two parts. For example - TO VALUE 100 on one Part and FROM VALUE 101 on another.

Audio Output Used (Menu Page 7)

This option determines which Audio outputs the Part sends its output signal to. When the **1 & 2** or **3 & 4** options are selected, the Chorus, Phaser, Delay and Panning Effects operate in stereo. The signals sent to the audio outputs are in true stereo. The Left signal is present on jacks 1 or 3 and the Right signal is present on jacks 2 or 4.

It is also possible to route the output signal to a single output jack. (This would be the case if using a MONO type sound such as a Bass). Any of the four audio outputs can be selected in this way. When a Part is assigned to a single audio output, the signal is mono and all of the Effects become MONO.

Note : In a Performance, it is possible to send all four Parts to any combination of output assignments. Any number of Parts can share the same output routings if required.

Pedal Options (Menu Page 8)

The response to a pedal connected to the Pedal Input on the Rear panel may be set using this Menu option.

The value may be any of the MIDI controllers 1 - 119. For example, the Filter uses controller number 105 to control the cut-off. Setting to this value will cause the Filter cut-off to change when the pedal is moved.

If this facility is used on Layered sounds, different values may be set on each part such that when the pedal is moved, the sound is affected in different ways.

Footswitch Options (Menu Page 9)

The response to a Foot switch connected to the Foot switch Input on the Rear panel may be set using this Menu option.

If OFF is selected there will be no response to a press on the switch. If Sustain is selected (the default) the sound on the part will sustain until the foot switch is released. If Arp On/Off is selected, the Arpeggiator will be switched on and off in the part.

MIDI Specification - MIDI Program Changes and Bank Select

MIDI Specification

Program Mode

In **Program Mode**, the keyboard notes, front panel controls, mod & pitch bend wheels and menu parameters all transmit on the **Global MIDI Channel**. This is set from page 2 of the Global Menu (see page 50)

In **Program Mode**, all MIDI messages are only accepted if they are received on the **Global MIDI Channel**.

Performance Mode

Each Part may be set to use its own MIDI channel. Any number of Parts may share and use the same MIDI channel (resulting in layered Parts).

The Part selected for editing (**it's RED edit light on**) will determine which MIDI channel will be used for transmission when the keyboard is played. the mod or pitch bend wheels moved, the front panel controls moved or a menu parameter changed. This MIDI channel can be changed in the Part Menu.

Some controls (such as the TEMPO knob) are not Part-specific and apply to the machine as a whole. In these cases, the **Global MIDI Channel** is always used for MIDI *transmission*. It is possible that the **Global MIDI channel** will be a different channel to those used by any of the Parts in the currently selected Performance. For MIDI reception of these non Part-specific controls, they may either be received on the **Global MIDI Channel** or on the MIDI channel used by any Part - providing of course that Part is 'active'.

This feature allows these messages to always be accepted regardless of which sequencer track is currently selected since sequencers 're-channelise' the incoming MIDI data.

When receiving MIDI information in **Performance Mode**, each Part will only respond to MIDI on its own MIDI channel (as defined in the Part Edit Menu). **A Part will only respond to incoming MIDI if it is 'active' (ie its Part Active button LED is lit).**

In **Performance Mode**, it is possible to utilise the Part Active buttons as 'mute' buttons. A 'muted' Part will not respond to or transmit MIDI.

MIDI Program Changes and Bank Select

Whenever a new Program or Performance is selected, a Bank Select Message followed immediately by a Program Change message will be transmitted. If these messages are played back into the machine from a sequencer, the appropriate Program or Performance will be selected.

The Bank Select MIDI message consists of a single controller message. Continuous Controller Number (CC32) (Bank Select LSB) is used. The machine does not transmit or respond to CC 0 (Bank Select MSB).

Sending a CC 0 message from a sequencer does no harm. The message will be ignored and the machine will behave as if the CC 0 had contained a data value of zero.

As well as determining which Program or Performance bank the Program Change Message will select from, the value of the Bank Select Message also determines whether **Program Mode** will be selected or the current playing mode retained. The following table lists the CC 32 values used.

CC 32 Bank Select messages	
No.	Description
1	Program 100 - 199 (Mode Unchanged)
2	Program 200 - 299 (Mode Unchanged)
3	Program 300 - 399 (Mode Unchanged)
4	Program 400 - 499 (Mode Unchanged)
5	Drum Map 500 - 549 (Mode Unchanged)
6	Drum Map 600 - 649 (Mode Unchanged)
7	Drum Map 700 - 749 (Mode Unchanged)
8	Drum Map 800 - 849 (Mode Unchanged)
33	Program 100 - 199 (Selects Program Mode)
34	Program 200 - 299 (Selects Program Mode)
35	Program 300 - 399 (Selects Program Mode)
36	Program 400 - 499 (Selects Program Mode)
37	Drum Map 500 - 549 (Selects Program Mode)
38	Drum Map 600 - 649 (Selects Program Mode)
39	Drum Map 700 - 749 (Selects Program Mode)
40	Drum Map 800 - 849 (Selects Program Mode)

Referring to the table above, when CC 32 values in the range of 1 to 8 are received, the following Program Change message will select a Program or Drum Map from the appropriate bank. It is these Bank Select values which are transmitted whenever a new Program or Drum Map is selected using the front panel controls (an exception is when the PROG button is pressed to select **Program Mode** - see below).

CC 32 values in the range 1 to 8 should always be used when a new Program is to be assigned to a Performance's Part. They can also be used when the KS 4 / KS 5 is already operating in **Program Mode** (**Program Mode** will remain selected).

CC 32 values of 33 to 40 are similar to values 1 to 8 in that they select Programs or Drum Maps. Unlike the 1 to 8 values, they always force the KS Rack to operate in **Program Mode**. This means that the machine will immediately switch to **Program Mode** even if these messages are received while **Performance Mode** is operating. These CC 32 values are only transmitted by the KS 4 / KS 5 at the time the PROG button is pressed to select **Program Mode**.

A Bank select message (CC 32) with a value of 65 selects **Performance Mode**. The following Program Change message will then select from Performances 1 to 100.

If the KS Rack is currently operating in **Performance Mode**, any Bank Select and Program Change messages may be received on either any of the Part's MIDI channels or on the Global MIDI channel.

A Program Change message always immediately follows a Bank Select message.

Only Program Change values of 000 to 099 are valid. When selecting a Drum Map, only Program Change values of 000 to 049 are valid. All other values will be ignored if received.

When a Bank Select Message is received, the Program / Drum Map / Performance will only change after the accompanying Program Change message has been received.

MIDI Implementation Chart

Model : Novation KS Rack

Date 9/12/02
Version 1.0

Function		Transmitted	Received	Remarks
Basic Channel	Default	1 - 16	1 - 16	Memorised
	Changed	1 - 16	1 - 16	
Mode	Default Messages Altered	X *****	MODE 3 - 4 X	Memorised in Program Data
Note Number	True Voice	0 - 127 *****	0 - 127	Note data can be transmitted by the Arpeggiators
Velocity	Note On Note Off	O v = 1 - 127 X	O v = 1 - 127 X	
Aftertouch	Keys Channel	X X	X O	
Pitch Bend		X	O	8 Bit data
Control Change		1, 3, 5 - 10 12 - 37, 40 - 65 67 - 85, 87 - 89 91 - 95, 98, 100 102 - 112, 114 - 119	1 - 3, 5 - 10 12 - 37, 40 - 65 67 - 85, 87 - 89 92 - 95, 98, 100 102 - 112, 114 - 127	See Controller & NRPN tables for full details
Program Change	True	0 - 99 *****	0 - 99	
System Exclusive		O	O	Program, Performance & Global data dumps. OS upgrades
System Real-Time		X	O	Start Song, Clock
System Common		X	X	
Aux Messages	Local Control All Notes Off Active Sense Reset Control All Sound Off	O O X X X	O O X O O	

Mode 1 : OMNI ON, POLY Mode 2 : OMNI ON, MONO
Mode 3 : OMNI OFF, POLY Mode 4 : OMNI OFF, MONO

O : Yes
X : No

KS Rack Factory Preset Program Listings

There are two banks of Factory Preset single sounds. The first two banks are numbered from 100 - 299.

Bank1	No.	Category	Name
	100	Bass	ArkBass
	101	Dance	Trance Attack
	102	Arpeggio	Moving Target
	103	Dance	Mr Gurner
	104	Pad	Hark Angel
	105	EP/Clav	Rodywhirl
	106	Strings	Legato Strings
	107	Strings	PPG Me
	108	Organ	My mighty Organ
	109	Soft Lead	First Solo
	110	Bass	Accoustic Bass
	111	Arpeggio	MonoSeq
	112	Bells	Crystal Harp
	113	Softlead	Sine On
	114	Pad	Come On In
	115	Pad	Get me to Heaven
	116	Strings	Big Big String
	117	Brass	BrassString
	118	Organ	ChinOrgan
	119	Hard Lead	Nose Bleed
	120	Bass	It's The Bass
	121	Hard Lead	Sync Leader
	122	Arpeggio	MONO Dance
	123	Dance	Trancer
	124	Pad	Home Front
	125	EP/Clav	Fine Tines
	126	Strings	Symphones
	127	Brass	EV Bas
	128	Organ	Mr Ben
	129	Soft Lead	Summertime
	130	Bass	F Bass
	131	Soft Lead	Arksun
	132	Arpeggio	Loop the Loop
	133	Pad	Perfect Poly
	134	Pad	Beauty Lives
	135	EP/Clav	EPic
	136	Strings	Arco Strings
	137	Brass	Give me the Horn
	138	Dance	Throater MW
	139	Pad	Moving Out
	140	Bass	Techno Prison
	141	Arpeggio	Machinery
	142	Arpeggio	Bugs
	143	Motion	Lazy Strumit
	144	Pad	Fifthmas
	145	EP/Clav	Harpsi Cord
	146	Soft Lead	Square Law
	147	Brass	Classy Brassy
	148	Motion	Dancing fifths
	149	Soft Lead	Elp Me

Bank1	No.	Category	Name
	150	Bass	Hertz Ears
	151	Dance	Acid drop
	152	Arpeggio	Impress Me
	153	Dance	Classic 303
	154	Pad	Pad it Out
	155	EP/Clav	Girls Toy
	156	Strings	Wake up
	157	Brass	Obie Joyful
	158	Organ	Plucky Organ
	159	Strings	Film It
	160	Strings	No Drama
	161	Motion	Arp an Sass
	162	Arpeggio	Insect a Side
	163	Arpeggio	Lets Dance
	164	Pad	Sweet Thing
	165	Soft Lead	Velo 303
	166	Strings	Wooden Arc
	167	Bass	Thud Bass
	168	Organ	Skanking
	169	Soft Lead	Zy Lophone
	170	Bass	Don't Fret
	171	Hard Lead	Classic Sync
	172	Arpeggio	Pooch
	173	Pad	Glider
	174	Pad	KLM
	175	Motion	Rise up
	176	Strings	How Long String
	177	Arpeggio	HarpiArp
	178	Organ	Draw the Bar
	179	EP/Clav	ElectroClav
	180	Bass	Flat Puppet
	181	Hard Lead	Prog Rocker
	182	Arpeggio	Sticky Spitter
	183	Dance	Je' t'aime
	184	Pad	Time Traveler
	185	Arpeggio	Gaviscon
	186	Strings	String of Pearls
	187	Strings	Pull the String
	188	Bass	Wow Bass
	189	EP/Clav	Quite Times
	190	Bass	In the Moog
	191	Pad	Fade to Grey
	192	Arpeggio	Maroder
	193	Organ	Dance Worgan
	194	Pad	Infinite Pad
	195	Dance	Club it
	196	Soft Lead	Pipe It
	197	Arpeggio	Simon Templar
	198	Hard Lead	Wired
	199	Arpeggio	Ride the Pluck

KS Rack Factory Preset Program Listings
--

Bank2		
No.	Category	Name
200	Bass	Passion Bass
201	Dance	Cake dear?
202	Arpeggio	Rhythm Flight
203	Dance	Go Lieth
204	Pad	Paddle Wheel
205	Bass	Bass Addict
206	Trance	Join the Club
207	EP/Clav	Chick Career
208	Bass	Thick Bass
209	Bells	Big Benny
210	Bass	Travelator
211	Hard Lead	Arabia
212	Arpeggio	Game Show
213	Dance	A Touch 2 Much
214	Dance	Azzeed
215	Dance	Trance Bass
216	Trance	A Wasp
217	Dance	Ian Vandal
218	Bass	String Bass
219	EP/Clav	Choco Eclav
220	Bass	Fruit Gums
221	Arpeggio	Sun Cream
222	SFX	Hyperspice
223	Dance	Circus of Humans
224	Soft Lead	PP3
225	Arpeggio	Round In Circles
226	Pad	Flush
227	Dance	All OSCS blazing
228	Organ	F' Ground
229	EP/Clav	Plink
230	Bass	Lay Tex
231	Sweep / Brass	Ky Lee Sweep
232	Arpeggio	ChatterBox
233	EP/Clav	Metal Tines
234	Arpeggio	Rand n Rand
235	Strings	Bow and Flex
236	Hard Lead	Twin Overdrive
237	Brass	Softy
238	Motion	Acidout
239	Hard Lead	Edgeit
240	Bass	On the Bounce
241	Hard Lead	It Feels Like
242	Arpeggio	Whos from Mars
243	EP/Clav	Klavicord
244	Pad	Radio Head
245	Soft Lead	Go to Church
246	Trance	Suspender
247	Brass	Simple Saw
248	Arpeggio	Arp Pad
249	Bass	FemBass

Bank2		
No.	Category	Name
250	Bass	Bootsy Bass
251	Hard Lead	Rub the Band
252	Arpeggio	Told you So
253	Dance	On the Ice
254	Arpeggio	Banjo Strump
255	Hard Lead	Squeeze One Out
256	Trance	Squeeler
257	Brass	Liquid Brass
258	SFX	Suck Me In
259	Brass	PWM block
260	Bass	Dark Paper
261	Hard Lead	Suck the Guitar
262	Arpeggio	Fly By
263	Soft Lead	Soft Finger
264	Pad	Lets Pluck
265	Dance	Get the Timp
266	Sweep	Pins and Needles
267	Pad	Silly Pad
268	Bass	BulgeBass
269	Drums / Perc	Witneys Pluck
270	Bass	Rubber Bass
271	Soft Lead	Toy string Guitar
272	Arpeggio	OctaBass
273	Dance	Swallow It!
274	Arpeggio	Arp Fantasy
275	EP/Clav	Light Finger
276	Bass	ResoBass
277	Sweep	At Mosfet
278	SFX	Cyber Landing
279	Bass	Garge Bass
280	Bass	Eastern Bass
281	Soft Lead	Arp not Arp
282	Arpeggio	Press a Chord
283	Dance	Chambers
284	Pad	Glass Whisper
285	Arp	Ali Gatter
286	Arpeggio	Blippy
287	Brass	Welcome Brass
288	Hard Lead	Lick Quid
289	Pad	The END
290	Bass	Slip Bass
291	Hard Lead	Monster Modular MW
292	Ep/Clav	Wurlit
293	Dance	Stop It Soon
294	Pad	Talk the Talk
295	Motion	Kotoswitch
296	Arpeggio	HarpBeat
297	Pad	Fminate
298	SFX	Space Storm
299	Vibratine	Vibratine

KS Rack Factory Preset Performance Listings
--

There are 100 Performances available in a single bank. The first 50 of these are Factory Presets, detailed in the table below. The table indicates which Parts and Drum Pattern (if any) are used, and the recommended TEMPO setting for use with the Performance.

Perf Number	Perf Name	Part 1 Prog No.	Part 2 Prog No.	Part 3 Prog No.	Part 4 Prog No.	Drum Patt Name	Bank	Tempo
100	Staple Diet	105	116	-	-	Ballad	500	90
101	Time Bomb	226	225	-	-	-	-	-
102	Arp Gurn	103	103	-	-	KicknHat	600	140
103	The Organ Twins	108	108	-	-	-	-	-
104	Both Nostrills	151	119	-	-	-	-	-
105	DX Heaven	292	105	-	-	Garage1	500	130
106	Xylo Dance	269	169	-	-	-	-	-
107	Prog Rock Burns	280	181	-	-	-	-	-
108	Velo Arp Pad	141	173	-	-	Electro	600	120
109	Angels Solos	104	109	-	-	-	-	-
110	Global Comms	290	115	-	-	House1	600	125
111	Bigger Benny	209	209	-	-	-	-	-
112	Softly Softly	104	196	-	-	-	-	-
113	Trance Licker	101	102	-	-	Trance	600	140
114	Mix Filler	116	116	-	-	-	-	-
115	Synced Flys Nest	175	202	-	-	-	-	-
116	Africa	174	269	-	-	Oh808oh	600	100
117	SuperSync	171	171	-	-	-	-	-
118	How Long	208	286	284	-	-	-	-
119	Cheeba Diva	145	274	-	-	-	-	-
120	Free & Ease	215	217	-	-	Trance	600	140
121	Push Out the Ark	131	144	-	-	-	-	-
122	Soloed Fifths	109	109	-	-	-	-	-
123	Walk the Organ	170	108	-	-	Pop	600	125
124	Velo Syn Loop	116	132	-	-	-	-	-
125	Padded Fifthmas	154	144	-	-	-	-	-
126	Gurners Seq	103	103	111	-	KicknHat	600	145
127	Lulabye Bye	126	271	-	-	-	-	-
128	Ice Winter	222	201	-	-	-	-	-
129	Sprung	299	269	-	-	SloGruve	600	75
130	Two Vandals	217	217	-	-	-	-	-
131	303 & 101	200	153	-	-	-	-	-
132	Clav for You	154	179	-	-	Pastlife	500	125
133	Mr & Mrs Gurner	103	103	-	-	-	-	-
134	World Com	287	115	-	-	-	-	-
135	Wide Draws	128	128	-	-	Reggae	500	85
136	Is It You	112	134	-	-	-	-	-
137	Bellisima	226	118	-	-	-	-	-
138	Kis5 FM	135	189	-	-	SloBreak	500	90
139	Hammer House	266	291	-	-	-	-	-
140	Filmwalker	221	207	-	-	-	-	-
141	Rrravers	198	107	-	-	Bungle	600	180
142	Ding Walls	224	253	-	-	-	-	-
143	The Strings	106	176	-	-	-	-	-
144	Gospel	108	168	-	-	-	-	-
145	Winker	220	153	-	-	Garage2	500	145
146	Split Ends	178	108	-	-	-	-	-
147	Brass & Bass	109	110	-	-	-	-	-
148	PercUp	540	500	504	600	-	-	-
149	Sympo Brass	117	176	-	-	-	-	-

KS Rack Factory Preset Drum Map Listings

Drum Map 500 - Standard Drum Kit

Ref	MIDI Note No.	Prog No.	Description
C1	36	500	Kick1
		501	Rimshot
	38	502	Snare1
		503	Clap
	40	504	Snare2
	41	505	Elect Tom Low
		506	Closed Hat1
	43	507	Elect Tom L Mid
		508	Closed Hat
	45	509	Elect Tom Mid
C2	47	510	Open Hi-Hat
		511	Elect Tom H Mid
	48	512	Elect Tom High
		513	Crash Cymbal 1
	50	514	Elect Tom V High
		515	Ride Cymbal
	52	516	Crash Cymbal 2
		517	Ride Cymbal 2
	53	518	Tambourine
		519	Crash Cymbal 3
C3	55	520	Cow Bell
		521	Crash Cymbal 4
	57	522	Vibraslap
		523	Ride Cymbal 3
	60	524	Bongo Low
		525	Shaker
	62	526	Bongo High
		527	Snare 3
	64	528	Snare 4
		529	Snare 5
C4	65	530	Snare 6
		531	Snare 7
	67	532	Snare 8
		533	Snare 9
	69	534	Snare 10
		535	Snare 11
	72	536	Kick 3
		537	Kick 4
	74	538	Kick 5
		539	Kick 6
76	540	Kick 7	
	77	541	Kick 8
		542	Kick 9
	79	543	Kick 10
		544	Kick 11
	81	545	Kick 12
		546	Kick 13
	83	547	Kick 14
		548	Kick 15
	84		

Drum Map 600 - Electronic Kit

Ref	MIDI Note No.	Prog No.	Description
C1	36	600	808 Kick 1
		601	808 Rimshot
	38	602	808 Snare 1
		603	Clap 1
	40	604	909 Snare
	41	605	Tom Hat
		606	Closed Hat1
	43	607	Tom L Mid
		608	Closed Hat
	45	609	Tom Mid
C2	47	610	Open Hi-Hat
		611	Tom H Mid
	48	612	Tom High
		613	Crash Cymbal
	50	614	Crash Cymbal 2
		615	Ride Cymbal
	52	616	Crash Cymbal 3
		617	909 Tom Low
	53	618	Tambourine
		619	909 Tom L Mid
C3	55	620	Cow Bell
		621	909 Tom Mid
	57	622	Ride Cymbal 2
		623	909 Tom H Mid
	60	624	909 Tom High
		625	808 Clap 2
	62	626	808 Tom Low
		627	808 Tom Mid
	64	628	808 Tom High
		629	909 Snare 2
C4	65	630	909 Snare 2
		631	808 Snare 3
	67	632	909 Snare 4
		633	808 Snare 3
	69	634	909 Snare 5
		635	909 Snare 6
	72	636	Synth Kick 1
		637	Synth Kick 2
	74	638	Synth Kick 3
		639	Synth Kick 4
76	640	Synth Kick 5	
	77	641	Synth Kick 6
		642	Synth Kick 7
	79	643	Synth Kick 8
		644	Synth Kick 9
	81	645	Synth Kick 10
		646	Synth Kick 11
	83	647	Synth Kick 12
		648	Synth Kick 13
	84		

MIDI Controller List

MIDI Controller List

Some controllers adhere to the normal midi-specified use (eg modwheel, volume) but most are used arbitrarily (and therefore may clash with parameter assignments of other products). We have tried to avoid misuse of some "standard" controllers which could cause problems.

Unless noted, controllers are transmitted and received. Unless noted, parameters have the range 0-127.

*** denotes a signed value where 64 represents zero.
Unless noted, this is -64..0..+63 stored as 0..64..127
another example is -12..0..+12 stored as 52..64..76

--- denotes controller not used

Some controllers use the available 7 data value bits to control more than one parameter. These are noted as "packed parameters" and details are given.

The term "pulse width" is properly applied when squarewave is selected.
For other waveforms, read "pulse width" as "double waveform phase offset".
Double waveform phase offset is zero when the signed pulse width position parameter is 64 (meaning 0).

Common parameters are transmitted and received on the global midi channel but in performance mode, they can also be received on the midi channel of any active part.

#	MIDI-SPECIFIED USE	KS SERIES USE
0	bank msb	IGNORED/NOT TRANSMITTED
1	modwheel msb	MODWHEEL
2	breath msb	BREATH CONTROL (receive only)
3	undefined msb	ARP PATTERN (0..7 = up, down, ud1, ud2, order, random, chord, drum)
4	foot controller msb	---
5	portamento time msb	PORTAMENTO TIME
6	data entry msb	USED FOR NRPN DATA VALUES
7	volume msb	PART VOLUME
8	balance msb	PREGLIDE SEMITONES *** -12..+12 (0=preglide disabled)
9	undefined msb	ARP/GENERAL SYNC RATE (64..191 bpm) (common)
10	pan msb	PAN POSITION ***
11	expression msb	EXPRESSION PEDAL
12	effect control 1 msb	NON-SYNC PAN RATE
13	effect control 2 msb	SYNC PAN RATE 0..34 (non-sync, 32Triplet..12bars)
14	undefined msb	VOCODER STEREO WIDTH (common)
15	undefined msb	VOCODER SIBILANCE LEVEL (common)
16	gen. controller 1 msb	MODWHEEL DISTORTION ***
17	gen. controller 2 msb	DISTORTION COMPENSATION
18	gen. controller 3 msb	MODWHEEL DELAY SEND
19	gen. controller 4 msb	NON-SYNC DELAY TIME
20	undefined msb	SYNC DELAY TIME 0..19 (non-sync, 32Triplet..2bars)
21	undefined msb	DELAY FEEDBACK
22	undefined msb	DELAY STEREO WIDTH
23	undefined msb	DELAY RATIO
24	undefined msb	MODWHEEL REVERB SEND ***
25	undefined msb	REVERB DECAY
26	undefined msb	MODWHEEL CHORUS SEND ***
27	undefined msb	NON-SYNC CHORUS RATE
28	undefined msb	SYNC CHORUS RATE 0..34 (non-sync, 32Triplet..12bars)
29	undefined msb	CHORUS FEEDBACK ***
30	undefined msb	CHORUS MOD DEPTH
31	undefined msb	CHORUS MOD CENTRE POINT
32	bank lsb	BANK SELECT 1..8 (bit 6 set forces perf mode, bit 5 set forces program mode)
33	modwheel lsb	EQ LEVEL *** (0, 1..63, 64, 65..126, 127 = LP, LPshelf, flat, HPshelf, HP)
34	breath lsb	EQ FREQUENCY
35	undefined lsb	NON-SYNC EQ MOD RATE
36	foot controller lsb	SYNC EQ MOD RATE 0..34 (non-sync, 32Triplet..12bars)
37	portamento time lsb	EQ MOD DEPTH
38	data entry lsb	---
39	volume lsb	---
40	balance lsb	OSC1 SEMITONE *** -12..+12
41	undefined lsb	OSC1 CENT *** -50..+50
42	pan lsb	OSC1 BENDWHEEL PITCH AMOUNT ***
43	expression lsb	OSC1 LFO1 PITCH AMOUNT ***
44	effect control 1 lsb	OSC1 MOD.ENV PITCH AMOUNT ***
45	effect control 2 lsb	OSC1 PULSE WIDTH POSITION *** (0=50% or in-phase double wave)
46	undefined lsb	OSC1 LFO2 PULSE WIDTH MOD ***
47	undefined lsb	OSC1 MOD.ENV PULSE WIDTH MOD ***
48	gen. controller 1 lsb	OSC2 SEMITONE *** -12..+12
49	gen. controller 2 lsb	OSC2 CENT *** -50..+50
50	gen. controller 3 lsb	OSC2 BENDWHEEL PITCH AMOUNT ***
51	gen. controller 4 lsb	OSC2 LFO1 PITCH AMOUNT ***

#	MIDI-SPECIFIED USE	KS SERIES USE
52	undefined lsb	OSC2 MOD.ENV PITCH AMOUNT ***
53	undefined lsb	OSC2 PULSE WIDTH POSITION *** (0=50% or in-phase double wave)
54	undefined lsb	OSC2 LFO2 PULSE WIDTH MOD ***
55	undefined lsb	OSC2 MOD.ENV PULSE WIDTH MOD ***
56	undefined lsb	OSC3 SEMITONE *** -12..+12
57	undefined lsb	OSC3 CENT *** -50..+50
58	undefined lsb	OSC3 BENDWHEEL PITCH AMOUNT ***
59	undefined lsb	OSC3 LFO1 PITCH AMOUNT ***
60	undefined lsb	OSC3 MOD.ENV PITCH AMOUNT ***
61	undefined lsb	OSC3 PULSE WIDTH POSITION *** (0=50% or in-phase double wave)
62	undefined lsb	OSC3 LFO2 PULSE WIDTH MOD ***
63	undefined lsb	OSC3 MOD.ENV PULSE WIDTH MOD ***
64	sustain pedal	SUSTAIN / MOMENTARY ARP LATCH ON
65	portamento on/off	ENVELOPE MONO MULTI MODES (see packed parameter 1)
66	sostenuto pedal	---
67	soft pedal	UNISON / VOICE TYPE / FILTER TYPE (see packed parameter 2)
68	legato footswitch	UNISON DETUNE
69	hold 2	INDIVIDUAL OSCILLATOR RANDOM DETUNE
70	sound controller 1	PORTAMENTO MODE (0=exp, 1=lin)
71	sound controller 2	OSC 1,2,3 OCTAVE / OSC 1>2 SYNC (see packed parameter 3)
72	sound controller 3	OSC1 LEVEL (to filter)
73	sound controller 4	OSC2 LEVEL (to filter)
74	sound controller 5	OSC3 LEVEL (to filter)
75	sound controller 6	NOISE LEVEL (to filter)
76	sound controller 7	OSC 1*2 RINGMOD LEVEL (to filter)
77	sound controller 8	EXTERNAL INPUT (to filter)
78	sound controller 9	LFO DELAY MONO MULTI MODE (see packed parameter 4)
79	sound controller 10	LFO 1,2 KEYSYNC / LOCK / ONE-SHOT (see packed parameter 5)
80	gen. controller 5 lsb	NON-SYNC LFO1 SPEED
81	gen. controller 6 lsb	SYNC LFO1 SPEED 0..34 (non-sync, 32Triplet..12bars)
82	gen. controller 7 lsb	LFO1 DELAY (GRADUAL ONSET TIME/ ONE-SHOT MODE DELAY)
83	gen. controller 8 lsb	NON-SYNC LFO2 SPEED
84	portamento control	SYNC LFO2 SPEED 0..34 (non-sync, 32Triplet..12bars)
85	undefined	LFO2 DELAY (GRADUAL ONSET TIME/ ONE-SHOT MODE DELAY)
86	undefined	--- (may be used in future software releases)
87	undefined	ARPEGGIATOR SYNC SETTING 0..15 (32Triplet..1 bar)
88	undefined	ARPEGGIATOR GATE TIME *** (+64 GIVES TIED NOTE IN MONO MODE)
89	undefined	ARPEGGIATOR CONTROL (see packed parameter 6)
90	undefined	DISTORTION LEVEL
91	effects 1 depth	REVERB SEND LEVEL
92	effects 2 depth	DELAY SEND LEVEL
93	effects 3 depth	CHORUS SEND LEVEL
94	effects 4 depth	PAN MOD DEPTH
95	effects 5 depth	VOCODER BALANCE (0=off 64=full vocoder 127=modulator only) (common)
96	data increment	---
97	data decrement	---
98	nrpn lsb	NRPN NUMBER
99	nrpn msb	IGNORED / NOT TRANSMITTED (for future compatibility, assume value is 0)
100	rpn lsb	---
101	rpn msb	---
102	undefined	FILTER FREQUENCY LFO2 MOD DEPTH ***
103	undefined	FILTER Q NORMALISE (127=zero filter drive at max resonance)
104	undefined	FILTER OVERDRIVE
105	undefined	FILTER FREQUENCY
106	undefined	FILTER RESONANCE
107	undefined	FILTER FREQUENCY MOD.ENV DEPTH ***
108	undefined	AMPLITUDE ENVELOPE ATTACK
109	undefined	AMPLITUDE ENVELOPE DECAY
110	undefined	AMPLITUDE ENVELOPE SUSTAIN
111	undefined	AMPLITUDE ENVELOPE RELEASE
112	undefined	AMPLITUDE ENVELOPE VELOCITY DEPTH ***
113	undefined	--- (may be used in future software releases)
114	undefined	MOD. ENVELOPE ATTACK
115	undefined	MOD. ENVELOPE DECAY
116	undefined	MOD. ENVELOPE SUSTAIN
117	undefined	MOD. ENVELOPE RELEASE
118	undefined	MOD. ENVELOPE VELOCITY DEPTH ***
119	undefined	VOICE TO OUTPUT & EFFECTS LEVEL BOOST (0..30dB)
120	all sounds off	ALL NOTES OFF WITH FAST RELEASE (receive only)
121	reset controllers	RESET CONTROLLERS (receive only)
122	local on/off	LOCAL ON/OFF (ALSO VALUE 63 IS USED FOR SEQUENCER MODE)
123	all notes off	ALL NOTES OFF (receive only)
124	omni off	ALL NOTES OFF (receive only)
125	omni on	ALL NOTES OFF (receive only)
126	mono mode setup	ALL NOTES OFF (receive only)
127	poly mode on	ALL NOTES OFF (receive only)

MIDI NRPN List

MIDI NRPN List

The KS series uses NRPNs as detailed below. Since less than 128 of them are used, only one NRPN msb (bank) is needed. Therefore only the NRPN lsb is transmitted/received and the NRPN msb is ignored and is not transmitted.

For future compatibility, assume that the NRPN msb is 0.

NRPN lsb	KS SERIES USE
0	FM FIXED LEVEL
1	FM ENVELOPE DEPTH ***
2	FM ENVELOPE VELOCITY DEPTH ***
3	FM ENVELOPE ATTACK
4	FM ENVELOPE DECAY
5	OSCs 1,2,3 MODWHEEL DIRECT PITCH DEPTH ***
6	OSCs 1,2,3 AFTERTOUCH DIRECT PITCH DEPTH ***
7	OSCs 1,2,3 BREATH DIRECT PITCH DEPTH ***
8	OSCs 1,2,3 MODWHEEL LFO1 PITCH DEPTH ***
9	OSCs 1,2,3 AFTERTOUCH LFO1 PITCH DEPTH ***
10	OSCs 1,2,3 BREATH LFO1 PITCH DEPTH ***
11	FILTER KEYBOARD TRACKING (0=NONE, 127=PRECISE PITCH TRACK)
12	FILTER MODWHEEL DIRECT FREQUENCY DEPTH ***
13	FILTER AFTERTOUCH DIRECT FREQUENCY DEPTH ***
14	FILTER BREATH DIRECT FREQUENCY DEPTH ***
15	FILTER MODWHEEL LFO2 FREQUENCY DEPTH ***
16	FILTER AFTERTOUCH LFO2 FREQUENCY DEPTH ***
17	FILTER BREATH LFO2 FREQUENCY DEPTH ***
18	AMPLITUDE MODWHEEL DIRECT DEPTH ***
19	AMPLITUDE AFTERTOUCH DIRECT DEPTH ***
20	AMPLITUDE BREATH DIRECT DEPTH ***
21	EFFECTS TYPE CONTROL (see packed parameter 7)
22	EFFECTS GLOBAL SYNC CONTROL (see packed parameter 8)
23	AUDIO INPUT CONTROL (see packed parameter 9)
24	VOCODER SIBILANCE TYPE (0=hp, 1=noise) (common)
25	EFFECT TYPE SELECTOR/KEYBOARD OCTAVE (see packed parameter 10)
26	OSC, SOURCE, PW, LFO SELECTORS (see packed parameter 11) (end of A/K-station similarity)
27-49	--- (may be used in future software releases)
50	OSC1 WAVEFORM (0..31)
51	OSC2 WAVEFORM (0..31)
52	OSC3 WAVEFORM (0..31)
53	LFO1 WAVEFORM (0..31)
54	LFO2 WAVEFORM (0..31)
55	LFO1 UNIPOLAR (0= centre-zero, 1=all positive)
56	LFO2 UNIPOLAR (0= centre-zero, 1=all positive)
57	LFO1 KEYSYNC START PHASE (0..357 degrees)
58	LFO2 KEYSYNC START PHASE (0..357 degrees)
59	LFO1 SYNC DELAY TIME 0..34 (non-sync, 32Triplet..12bars)
60	LFO2 SYNC DELAY TIME 0..34 (non-sync, 32Triplet..12bars)
61	MIX MODULATION SELECTOR (0=normal, 1=pots control mod levels)
62	FILTER TYPE (0..2 = LP, BP, HP)
63	OSC1 LFO1 LEVEL MOD ***
64	OSC2 LFO2 LEVEL MOD ***
65	OSC3 A/D ENV LEVEL MOD ***
66	NOISE LFO1 LEVEL MOD ***
67	RING1*2 LFO1 LEVEL MOD ***
68	AUDIO INPUT LFO1 LEVEL MOD ***
69	OSC123 WAVEFORM KEYSYNC PHASE (0..357 degrees)
70	NOISE TYPE (0..3 = white, hp, bp, hp*bp)
71	ARPEGGIATOR PATTERN (0..32 0=off, 32 patterns. In DRUM MODE, 33 patterns)
72	FILTER FREQUENCY VELOCITY CONTROL ***
73	ARPEGGIATOR PATTERN VELOCITY MODE (0=use note-on velocity, 1= use velocity in pattern)
74	FIXED NOTE CONTROL (0=off, 1-127 fix the note to midi 1..127 ie C#-2..G8)
75	LFO1 OUTPUT LEVEL VELOCITY CONTROL ***
76	LFO2 OUTPUT LEVEL VELOCITY CONTROL ***
77	OSC1 LFO2 LEVEL MOD ***
78	OSC 2>3 FM LFO1 DEPTH MOD ***
79	DRUM NOTE ON-TIME (0=turn off by note-off, 1-127=1msec..10sec auto-turn-off, ignoring note-off)
80-81	--- (may be used in future software releases)
82	CATEGORY (0..23) (currently not transmitted)
83	EXPRESSION PEDAL CONTROLLER NUMBER
84	FOOTSWITCH FUNCTION (0=sustain, 1=arp latch on override)
85	PART OUTPUT (0..5 = 1+2, 3+4, 1, 2, 3, 4)
86	PART MIDI CHANNEL (0..15 Note that in program mode, the global channel is used)
87	PART LOW NOTE LIMIT
88	PART HIGH NOTE LIMIT
89	PART SEMITONE OFFSET ***
90	PART CENT OFFSET ***
91	PART VELOCITY FUNCTION (0..15 0=normal, 1=inverse, 2=xfade hi, 3=xfade lo, 12 limit settings)
92-99	--- (may be used in future software releases)
100	PERFORMANCE VOCODER PART SELECTION (0..3 for parts 1..4) (common)
101-111	--- (may be used in future software releases)

NRPNs FOR GLOBAL DATA (not part of programs or performances)

NRPN Isb	KS SERIES USE
113	GLOBAL MIDI CHANNEL (0..15)
114	MIDI CLOCK SOURCE (0=internal 1=external)
115	MASTER TUNE CENTS ***
116	VELOCITY CURVE (0=soft 1=hard)
117	EXTERNAL INPUT RANGE (0=line 1=mic)
118	EXTERNAL INPUT TRIM (-10..+20 dB)
119	EXTERNAL INPUT TRIGGER SENSITIVITY (0 is most sensitive)
120	GLOBAL SYNC TYPE (0,1,2 = note when all notes off, first note after prog change, midi song start)
121	PARAMETER MOMENTARY DISPLAY TIME (off.200..1200mS)
122	MENU INITIAL PAGE MODE (0=first 1=last used)
123	PROGRAM MODE PARAMETER DISPLAY MODE (0=timed 1=permanent)
124-127	--- (may be used in future software releases)

Packed Controller / NRPN Details

Refer to the lists of MIDI Controllers and NRPNs on pages 61 - 63.

1	ENVELOPES MONO SINGLE-MULTI bit 0 amp env trigger 0=single 1=multi bit 1 mod env trigger 0=single 1=multi bit 2 fm env trigger 0=single 1=multi
2	UNISON / POLY MODE / FILTER TYPE bits 0-2 3-bit unison count 0=off 1..7=2..8 voices bits 3-4 2-bit voice polyphony mode 0=mono 1=mono autoglide 2=poly 3=poly with "same note voice stealing" bit 5 filter type 0=12dB 1=24dB per octave
3	OSC 1,2,3 OCTAVE / OSC 1>2 SYNC bits 0-1 2-bit osc1 octave -1,0,1,2 bits 2-3 2-bit osc2 octave -1,0,1,2 bits 4-5 2-bit osc3 octave -1,0,1,2 bit 6 osc1>2 sync 1=on
4	LFO 1,2 DELAY MONO MULTI MODE bit 0 lfo1 delay multi 1=on bit 1 lfo2 delay multi 1=on
5	LFO 1,2 KEYSYNC / LOCK / ONE-SHOT bit 0 lfo1 one-shot mode 1=on bit 1 lfo1 keysync 1=on bit 2 lfo1 lock 0=independent per voice 1=all voices same phase bit 3 lfo2 one-shot mode 1=on bit 4 lfo2 keysync 1=on bit 5 lfo2 lock 0=independent per voice 1=all voices same phase note that when lock is on, keysync becomes global sync (ie note when all notes off, first note after prog change, song start message)
6	ARPEGGIATOR CONTROL bits 0-1 2-bit number of octaves 1,2,3,4 bit 2 arpeggiator off/on 1=on bit 3 arpeggiator keysync control 1=on bit 4 arpeggiator latch control 1=on
7	EFFECTS TYPE CONTROL bits 0-2 3-bit reverb type (values 6,7 not used) bit 3 chorus/phaser control 0=chorus 1=phaser
8	EFFECTS GLOBAL SYNC CONTROL bits 0-1 2-bit chorus global sync off,left,centre,right bits 2-3 2-bit pan global sync off,left,centre,right bits 4-5 2-bit eq frequency global sync off,low,mid,high
9	AUDIO INPUT CONTROL bit 5 audio input trigger control 1=enabled bit 6 audio input to fx control 1=enabled
10	EFFECT TYPE SELECTOR / KEYBOARD OCTAVE bits 0-2 3-bit effect type (del, rev, chor, dist, EQ, pan, vocoder) Value 7 not used) bits 3-6 4-bit signed keyboard octave shift -3..+3 (+4 on KS4)
11	OSC / NOISE-RING-EXT / PW / LFO SELECTORS bits 0-1 2-bit osc select. Values 0,1,2 for osc 1,2,3. Value 3 not used bits 2-3 2-bit source select. Values 0,1,2 for noise, ring, ext. Value 3 not used bits 4-5 2-bit PW select. Values 0,1,2 for position, lfo2, mod env. Value 3 not used bit 6 0=lfo1, 1=lfo2

MIDI System Exclusive

MIDI System Exclusive Message Formats

SYSEX MESSAGE COMMON FORMAT

F0h	SYSEX START	
00h	NOVATION ID 1	
20h	NOVATION ID 2	
29h	NOVATION ID 3	
01h	DEVICE TYPE	(1 = synth)
42h	KS SERIES	(KS4, KS5, KS rack)
SyCh	SYSEX CHANNEL	(always transmitted as 7Fh : for receive can be 7Fh or the global channel)
M	MESSAGE TYPE	(current sound, program, global data etc)
C	CONTROL BYTE	(used to control destination bank when program dumps are received)
Vv	SOFTWARE VERSION	(bits:- 0VVVV.vvv eg 00001000 = version 1.0)
Vi	VERSION INCREMENT 0..99	(hold keypad "5" during power-up to view the full version eg 1.0.06)
B	PROG BANK 1..8, PERF BANK 1	(zero if not appropriate)
P	PROG/PERF NUMBER 0..99	(zero if not appropriate)
DATA BLOCK	(data block(s))	
.	(included if)	
.	(appropriate to)	
DATA BLOCK	(message type)	
F7h	END OF EXCLUSIVE	

Note: Currently, the software version and increment bytes are transmitted for information only and are ignored when a message is received. Future software releases may, on receipt of some message types from an earlier version, alter the data before storing it. This will only apply to messages which contain data blocks. To ensure future compatibility, librarian programs should always maintain a match between the Vv and Vi byte values and the data block content.

SYSEX DATA DUMP MESSAGES

PROGRAM-MODE CURRENT SOUND DUMP

When received in program mode, this will be the active sound. It is not stored in flash. In performance mode, this message is ignored. The source bank and program number are irrelevant and the control byte is ignored.

F0h	SYSEX START	
00h	NOVATION ID 1	
20h	NOVATION ID 2	
29h	NOVATION ID 3	
01h	DEVICE TYPE	
42h	KS SERIES	
SyCh	SYSEX CHANNEL	transmitted 7Fh : received 7Fh or current receive channel
00h	MESSAGE TYPE	current program dump
00h	CONTROL BYTE	transmitted 0 : received don't care
Vv	SOFTWARE VERSION	
Vi	VERSION INCREMENT	
00h	PROGRAM BANK	transmitted 0 : received don't care
00h	PROGRAM NUMBER	transmitted 0 : received don't care
PROGRAM BLOCK	256 bytes, see below	
F7h	END OF EXCLUSIVE	

PROGRAM DUMP

When received, the sound is stored in flash at the supplied bank and program number if C = 1. If C = 0, the bank used is the currently selected bank.

F0h	SYSEX START	
00h	NOVATION ID 1	
20h	NOVATION ID 2	
29h	NOVATION ID 3	
01h	DEVICE TYPE	
42h	KS SERIES	
SyCh	SYSEX CHANNEL	transmitted 7Fh : received 7Fh or current receive channel
01h	MESSAGE TYPE	program dump
C	CONTROL BYTE	0 or 1 destination bank control
Vv	SOFTWARE VERSION	
Vi	VERSION INCREMENT	
B	PROGRAM BANK	transmitted 1-8 : received don't care if C=0
P	PROGRAM NUMBER	0-99 for program banks 1-4, 0-49 for drum banks 5-8
PROGRAM BLOCK	256 bytes, see below	
F7h	END OF EXCLUSIVE	

PRORAM BANK DUMPS

A program bank (1-4) dump consists of 100 consecutive program dumps.

A drum bank (5-8) dump consists of 50 consecutive program dumps. The first 49 (program number 0-48) are drum sounds (the effects parameters of these are not normally used). The last (program number 49) has the effects settings for the entire drum bank (the voice parameters are not used).

When a single bank dump is transmitted, C=0 such that the receiving KSx current bank will be the destination.

When an all banks dump is transmitted, C=1 such that the receiving KSx will store the programs in the bank given in the B byte.

When a third party librarian or device receives either a program dump, it can ignore the C value but when it transmits one of these dumps to a KSx, it must be aware of the effect of the C value.

PERFORMANCE-MODE CURRENT SOUND DUMP

When received in performance mode, this will be the active sound. It is not stored in flash. In program mode, this message is ignored.

The source bank and program number are irrelevant and the control byte is ignored.

F0h	SYSEX START	
00h	NOVATION ID 1	
20h	NOVATION ID 2	
29h	NOVATION ID 3	
01h	DEVICE TYPE	
42h	KS SERIES	
SyCh	SYSEX CHANNEL	transmitted 7Fh : received 7Fh or current receive channel
02h	MESSAGE TYPE	current performance dump
00h	CONTROL BYTE	transmitted 0 : received don't care
Vv	SOFTWARE VERSION	
Vi	VERSION INCREMENT	
00h	PERFORMANCE BANK	transmitted 0 : received don't care
00h	PERFORMANCE NUMBER	transmitted 0 : received don't care
PART 1 PROGRAM BLOCK 256 bytes, see below. The performance parameters are stored in this block		
PART 2 PROGRAM BLOCK 256 bytes		
PART 3 PROGRAM BLOCK 256 bytes		
PART 4 PROGRAM BLOCK 256 bytes		
F7h	END OF EXCLUSIVE	

PERFORMANCE DUMP

When received, the performance is stored in flash at the supplied performance number.

F0h	SYSEX START	
00h	NOVATION ID 1	
20h	NOVATION ID 2	
29h	NOVATION ID 3	
01h	DEVICE TYPE	
42h	KS SERIES	
SyCh	SYSEX CHANNEL	transmitted 7Fh : received 7Fh or current receive channel
03h	MESSAGE TYPE	performance dump
C	CONTROL BYTE	0 or 1 destination bank control
Vv	SOFTWARE VERSION	
Vi	VERSION INCREMENT	
B	PERFORMANCE BANK	transmitted 1 : received don't care
P	PERFORMANCE NUMBER	0-99
PART 1 PROGRAM BLOCK 256 bytes, see below. The performance parameters are stored in this block		
PART 2 PROGRAM BLOCK 256 bytes		
PART 3 PROGRAM BLOCK 256 bytes		
PART 4 PROGRAM BLOCK 256 bytes		
F7h	END OF EXCLUSIVE	

PERFORMANCE BANK DUMPS

A performance bank dump consists of 50 consecutive performance dumps, either performances 0-49 or 50-99 depending on the selected dump item.

The reason for splitting the bank into two halves is simply to keep sysex/midi files reasonably small.

MIDI System Exclusive

GLOBAL DATA DUMP

When received, the flash global data block is overwritten. The source bank and program number are irrelevant and the control byte is ignored.

F0h	SYSEX START	
00h	NOVATION ID 1	
20h	NOVATION ID 2	
29h	NOVATION ID 3	
01h	DEVICE TYPE	
42h	KS SERIES	
SyCh	SYSEX CHANNEL	transmitted 7Fh : received 7Fh or current receive channel
04h	MESSAGE TYPE	global data dump
00h	CONTROL BYTE	transmitted 0 : received don't care
Vv	SOFTWARE VERSION	
Vi	VERSION INCREMENT	
00h	(PROGRAM BANK)	transmitted 0 : received don't care
00h	(PROGRAM NUMBER)	transmitted 0 : received don't care
GLOBAL DATA BLOCK 256 bytes, see below		
F7h	END OF EXCLUSIVE	

SYSEX REQUEST MESSAGES (receive only)**PROGRAM MODE CURRENT SOUND DUMP REQUEST**

In performance mode, this message is ignored.

F0h	SYSEX START	
00h	NOVATION ID 1	
20h	NOVATION ID 2	
29h	NOVATION ID 3	
01h	DEVICE TYPE	
42h	KS SERIES	
SyCh	SYSEX CHANNEL	7Fh or current receive channel
40h	MESSAGE TYPE	current program dump request
00h	CONTROL BYTE	don't care
Vv	SOFTWARE VERSION	don't care
Vi	VERSION INCREMENT	don't care
00h	PROGRAM BANK	don't care
00h	PROGRAM NUMBER	don't care
F7h	END OF EXCLUSIVE	

PROGRAM DUMP REQUEST

F0h	SYSEX START	
00h	NOVATION ID 1	
20h	NOVATION ID 2	
29h	NOVATION ID 3	
01h	DEVICE TYPE	
42h	KS SERIES	
SyCh	SYSEX CHANNEL	7Fh or current receive channel
41h	MESSAGE TYPE	program dump request
C	CONTROL BYTE	reply will copy this value for C
Vv	SOFTWARE VERSION	don't care
Vi	VERSION INCREMENT	don't care
B	PROGRAM BANK	1-8 : don't care if C=0
P	PROGRAM NUMBER	0-99 for program banks 1-4, 0-49 for drum banks 5-8
F7h	END OF EXCLUSIVE	

PERFORMANCE MODE CURRENT SOUND DUMP REQUEST

In program mode, this message is ignored.

F0h	SYSEX START	
00h	NOVATION ID 1	
20h	NOVATION ID 2	
29h	NOVATION ID 3	
01h	DEVICE TYPE	
42h	KS SERIES	
SyCh	SYSEX CHANNEL	7Fh or current receive channel
42h	MESSAGE TYPE	current performance dump request
00h	CONTROL BYTE	don't care
Vv	SOFTWARE VERSION	don't care
Vi	VERSION INCREMENT	don't care
00h	PERFORMANCE BANK	don't care
00h	PERFORMANCE NUMBER	don't care
F7h	END OF EXCLUSIVE	

PERFORMANCE DUMP REQUEST

F0h	SYSEX START	
00h	NOVATION ID 1	
20h	NOVATION ID 2	
29h	NOVATION ID 3	
01h	DEVICE TYPE	
42h	KS SERIES	
SyCh	SYSEX CHANNEL	7Fh or current receive channel
43h	MESSAGE TYPE	performance dump request
C	CONTROL BYTE	reply will copy this value for C
Vv	SOFTWARE VERSION	don't care
Vi	VERSION INCREMENT	don't care
B	PERFORMANCE BANK	don't care : in the returned performance dump this will be 1
P	PERFORMANCE NUMBER	0-99
F7h	END OF EXCLUSIVE	

GLOBAL DATA DUMP REQUEST

F0h	SYSEX START	
00h	NOVATION ID 1	
20h	NOVATION ID 2	
29h	NOVATION ID 3	
01h	DEVICE TYPE	
42h	KS SERIES	
SyCh	SYSEX CHANNEL	7Fh or current receive channel
44h	MESSAGE TYPE	global data dump request
00h	CONTROL BYTE	don't care
Vv	SOFTWARE VERSION	don't care
Vi	VERSION INCREMENT	don't care
00h	(PROGRAM BANK)	don't care
00h	(PROGRAM NUMBER)	don't care
F7h	END OF EXCLUSIVE	

DATA BLOCKS USED IN SYSEX MESSAGES

See Midi Controller Map for further details of parameters and meaning of ***.

PROGRAM DATA BLOCK (256 bytes)

byte	parameter
0	UNISON / VOICE TYPE / FILTER TYPE (see packed parameter 2)
1	UNISON DETUNE
2	INDIVIDUAL OSCILLATOR RANDOM DETUNE (VCO DRIFT)
3	PORTAMENTO TIME
4	PREGlide SEMITONES *** -12..+12 (0=preglide disabled)
5	PORTAMENTO MODE (0=exp, 1=linear)
6	OSC 1,2,3 OCTAVE / OSC 1>2 SYNC (see packed parameter 3)
7	OSC1 SEMITONE *** -12..+12
8	OSC1 CENT *** -50..+50
9	OSC1 BENDWHEEL PITCH AMOUNT ***
10	OSC1 LFO1 PITCH AMOUNT ***
11	OSC1 MOD.ENV PITCH AMOUNT ***
12	OSC1 PULSE WIDTH POSITION *** (0=50% or in-phase double wave)
13	OSC1 LFO2 PULSE WIDTH MOD ***
14	OSC1 MOD.ENV PULSE WIDTH MOD ***
15	OSC2 SEMITONE *** -12..+12
16	OSC2 CENT *** -50..+50
17	OSC2 BENDWHEEL PITCH AMOUNT ***
18	OSC2 LFO1 PITCH AMOUNT ***
19	OSC2 MOD.ENV PITCH AMOUNT ***
20	OSC2 PULSE WIDTH POSITION *** (0=50% or in-phase double wave)
21	OSC2 LFO2 PULSE WIDTH MOD ***
22	OSC2 MOD.ENV PULSE WIDTH MOD ***
23	OSC3 SEMITONE *** -12..+12
24	OSC3 CENT *** -50..+50
25	OSC3 BENDWHEEL PITCH AMOUNT ***
26	OSC3 LFO1 PITCH AMOUNT ***
27	OSC3 MOD.ENV PITCH AMOUNT ***
28	OSC3 PULSE WIDTH POSITION *** (0=50% or in-phase double wave)
29	OSC3 LFO2 PULSE WIDTH MOD ***
30	OSC3 MOD.ENV PULSE WIDTH MOD ***
31	OSCs 1,2,3 MODWHEEL DIRECT PITCH DEPTH ***
32	OSCs 1,2,3 AFTERTOUCH DIRECT PITCH DEPTH ***
33	OSCs 1,2,3 BREATH DIRECT PITCH DEPTH ***
34	OSCs 1,2,3 MODWHEEL LFO1 PITCH DEPTH ***

MIDI System Exclusive

byte	parameter
35	OSCs 1,2,3 AFTERTOUCHE LFO1 PITCH DEPTH ***
36	OSCs 1,2,3 BREATH LFO1 PITCH DEPTH ***
37	OSC1 LEVEL (to filter)
38	OSC2 LEVEL (to filter)
39	OSC3 LEVEL (to filter)
40	NOISE LEVEL (to filter)
41	OSC 1*2 RINGMOD LEVEL (to filter)
42	AUDIO INPUT LEVEL (to filter)
43	FILTER OVERDRIVE
44	FILTER RESONANCE
45	FILTER Q NORMALISE (127=zero filter drive at max resonance)
46	FILTER FREQUENCY
47	FILTER KEYBOARD TRACKING (0=NONE, 127=PRECISE PITCH TRACK)
48	FILTER MODWHEEL DIRECT FREQUENCY DEPTH ***
49	FILTER AFTERTOUCHE DIRECT FREQUENCY DEPTH ***
50	FILTER BREATH DIRECT FREQUENCY DEPTH ***
51	FILTER FREQUENCY LFO2 MOD DEPTH ***
52	FILTER FREQUENCY MOD.ENV DEPTH ***
53	FILTER MODWHEEL LFO2 FREQUENCY DEPTH ***
54	FILTER AFTERTOUCHE LFO2 FREQUENCY DEPTH ***
55	FILTER BREATH LFO2 FREQUENCY DEPTH ***
56	OSC 2>3 FM FIXED LEVEL
57	OSC 2>3 FM ENVELOPE DEPTH ***
58	OSC 2>3 FM ENVELOPE VELOCITY DEPTH ***
59	OSC 2>3 FM ENVELOPE ATTACK
60	OSC 2>3 FM ENVELOPE DECAY
61	AMPLITUDE ENVELOPE VELOCITY DEPTH ***
62	AMPLITUDE ENVELOPE ATTACK
63	AMPLITUDE ENVELOPE DECAY
64	AMPLITUDE ENVELOPE SUSTAIN
65	AMPLITUDE ENVELOPE RELEASE
66	MOD. ENVELOPE VELOCITY DEPTH ***
67	MOD. ENVELOPE ATTACK
68	MOD. ENVELOPE DECAY
69	MOD. ENVELOPE SUSTAIN
70	MOD. ENVELOPE RELEASE
71	(not used, set to 0)
72	NON-SYNC LFO1 SPEED
73	SYNC LFO1 SPEED 0..34 (non-sync, 32Triplet..12bars)
74	LFO1 DELAY (GRADUAL ONSET TIME / ONE-SHOT MODE DELAY)
75	NON-SYNC LFO2 SPEED
76	SYNC LFO2 SPEED 0..34 (non-sync, 32Triplet..12bars)
77	LFO2 DELAY (GRADUAL ONSET TIME / ONE-SHOT MODE DELAY)
78	LFO 1,2 DELAY MONO MULTI MODE (see packed parameter 4)
79	LFO 1,2 KEYSYNC / LOCK / ONE-SHOT (see packed parameter 5)
80	ENVELOPE MONO MULTI MODES (see packed parameter 1)
81	AMPLITUDE MODWHEEL DIRECT DEPTH ***
82	AMPLITUDE AFTERTOUCHE DIRECT DEPTH ***
83	AMPLITUDE BREATH DIRECT DEPTH ***
84	ARPEGGIATOR/GENERAL SYNC RATE (64..191 bpm) (common)
85	ARPEGGIATOR SYNC SETTING 0..15 (32Triplet..1 bar)
86	ARPEGGIATOR GATE TIME ***(+63 gives tied notes in mono mode)
87	ARP MODE (0..7 = up, down, ud1, ud2, order, random, chord, drum)
88	ARPEGGIATOR CONTROL (see packed parameter 6)
89	VOCODER BALANCE (0=off 64=full vocoder 127=modulator only) (common)
90	VOCODER STEREO WIDTH (common)
91	VOCODER SIBILANCE LEVEL (common)
92	EQ LEVEL *** (0, 1..63, 64, 65..126, 127 = LP, LPshelf, flat, HPshelf, HP)
93	EQ FREQUENCY
94	NON-SYNC EQ MOD RATE
95	SYNC EQ MOD RATE 0..34 (non-sync, 32Triplet..12bars)
96	EQ MOD DEPTH
97	DISTORTION LEVEL
98	MODWHEEL DISTORTION ***
99	DISTORTION COMPENSATION
100	DELAY SEND LEVEL
101	MODWHEEL DELAY SEND
102	NON-SYNC DELAY TIME
103	SYNC DELAY TIME 0..19 (non-sync, 32Triplet..2bars)
104	DELAY FEEDBACK
105	DELAY STEREO WIDTH
106	DELAY RATIO
107	REVERB SEND LEVEL
108	MODWHEEL REVERB SEND ***
109	REVERB DECAY

byte	parameter
110	CHORUS SEND LEVEL
111	MODWHEEL CHORUS SEND ***
112	NON-SYNC CHORUS RATE
113	SYNC CHORUS RATE 0..34 (non-sync, 32Triplet..12bars)
114	CHORUS FEEDBACK ***
115	CHORUS MOD DEPTH
116	CHORUS MOD CENTRE POINT
117	PAN POSITION ***
118	NON-SYNC PAN RATE
119	SYNC PAN RATE 0..34 (non-sync, 32Triplet..12bars)
120	PAN MOD DEPTH
121	EFFECTS TYPE CONTROL (see packed parameter 7)
122	EFFECTS GLOBAL SYNC CONTROL (see packed parameter 8)
123	AUDIO INPUT CONTROL (see packed parameter 9)
124	VOCODER SIBILANCE TYPE (0=hp, 1=noise) (common)
125	VOICE LEVEL TO OUTPUT & EFFECTS (0..30Db)
126	EFFECT TYPE SELECTOR/KEYBOARD OCTAVE (see packed parameter 10)
127	OSC. SOURCE, PW, LFO SELECTORS (see packed parameter 11)
	(end of A/K-station similarity)
128	OSC1 WAVEFORM (0..31)
129	OSC2 WAVEFORM (0..31)
130	OSC3 WAVEFORM (0..31)
131	LFO1 WAVEFORM (0..31)
132	LFO2 WAVEFORM (0..31)
133	LFO1 UNIPOLAR (0= centre-zero, 1=all positive)
134	LFO2 UNIPOLAR (0= centre-zero, 1=all positive)
135	LFO1 KEYSYNC START PHASE (0..357 degrees)
136	LFO2 KEYSYNC START PHASE (0..357 degrees)
137	LFO1 SYNC DELAY TIME 0..34 (non-sync, 32Triplet..12bars)
138	LFO2 SYNC DELAY TIME 0..34 (non-sync, 32Triplet..12bars)
139	MIX MODULATION SELECTOR (0=normal, 1=pots control mod levels)
140	FILTER TYPE (0..2 = LP, BP, HP)
141	OSC1 LFO1 LEVEL MOD ***
142	OSC2 LFO2 LEVEL MOD ***
143	OSC3 A/D ENV LEVEL MOD ***
144	NOISE LFO1 LEVEL MOD ***
145	RING1*2 LFO1 LEVEL MOD ***
146	AUDIO INPUT LFO1 LEVEL MOD ***
147	OSC123 WAVEFORM KEYSYNC PHASE (0..357 degrees)
148	NOISE TYPE (0..3 = white, hp, bp, hp*bp)
149	ARPEGGIATOR PATTERN (0..32 0=off, 32 patterns. In DRUM MODE, 33 patterns)
150	FILTER FREQUENCY VELOCITY CONTROL ***
151..166	PROGRAM NAME (16 ascii characters)
167	ARPEGGIATOR PATTERN VELOCITY MODE (0=use note-on velocity, 1= use velocity in pattern)
168	FIXED NOTE CONTROL (0=off, 1-127 fix the note to midi 1..127 ie C#-2..G8)
169	LFO1 OUTPUT LEVEL VELOCITY CONTROL ***
170	LFO2 OUTPUT LEVEL VELOCITY CONTROL ***
171	OSC1 LFO2 LEVEL MOD ***
172	OSC 2>3 FM LFO1 DEPTH MOD ***
173	DRUM NOTE ON-TIME (0=turn off by note-off, 1-127=1msec..10sec auto-turn-off, ignoring note-off)
174	(not used, set to 0)
175	(not used, set to 0)
176	CATEGORY (0..23)
177	EXPRESSION PEDAL CONTROLLER NUMBER
178	FOOTSWITCH FUNCTION (0=sustain, 1=arp latch on override)
PART PARAMETERS (note that most of these operate in both program and performance mode)	
179	PART LEVEL
180	PART OUTPUT (0..5 = 1+2, 3+4, 1, 2, 3, 4)
181	PART MIDI CHANNEL (0..15 Note that in program mode, the global channel is used)
182	PART LOW NOTE LIMIT
183	PART HIGH NOTE LIMIT
184	PART SEMITONE OFFSET ***
185	PART CENT OFFSET ***
186	PART VELOCITY FUNCTION (0..15 0=normal, 1=inverse, 2=xfade hi, 3=xfade lo, then 12 limit settings)
PERFORMANCE PARAMETERS stored in each part's data block	
187	PART ORIGINAL PROGRAM BANK (1..8)
188	PART ORIGINAL PROGRAM NUMBER (0..99)

MIDI System Exclusive

PERFORMANCE PARAMETERS stored in part 1's data block only

byte	parameter
189	PERFORMANCE PART EDIT SELECTION (bits 0..3 are 1 for parts 1..4 respectively)
190	PERFORMANCE PART ON SELECTION (bits 0..3 are 1 for parts 1..4 respectively)
191	PERFORMANCE TEMPO BPM (this is the performance's version of parameter 84)
192..207	PERFORMANCE NAME (16 ascii characters)
208	PERFORMANCE VOCODER PART SELECTION (0..3 for parts 1..4)
209..255	(not used, set to 0)

GLOBAL DATA BLOCK (256 bytes)

byte	parameter
0	POWER-UP PERFORMANCE MODE PERFORMANCE BANK (always 1)
1	POWER-UP PERFORMANCE MODE PERFORMANCE NUMBER
2	POWER-UP PROGRAM MODE PROGRAM BANK 1..8
3	POWER-UP PROGRAM MODE PROGRAM NUMBER 0..99 banks 1-4, 0-49 banks 5-8
4	POWER-UP MODE (0=program, 1=performance)
5	MEMORY PROTECT (0=protected 1=not protected)
6	(not used, set to 15)
7	MIDI LOCAL CONTROL (0=off 127=on 63=sequencer mode)
8	GLOBAL MIDI CHANNEL (0..15)
9	MIDI CLOCK SOURCE (0=internal 1=external)
10	MASTER TUNE CENTS ***
11	VELOCITY CURVE (0=soft 1=hard)
12	EXTERNAL INPUT RANGE (0=line 1=mic)
13	EXTERNAL INPUT TRIM (-10..+20 dB)
14	EXTERNAL INPUT TRIGGER SENSITIVITY (0 is most sensitive)
15	GLOBAL SYNC TYPE (0,1,2 = note when all notes off, first note after prog change, midi song start)
16	PARAMETER MOMENTARY DISPLAY TIME (off.200..1200mS)
17	MENU INITIAL PAGE MODE (0=first 1=last used)
18	PROGRAM MODE PARAMETER DISPLAY MODE (0=timed 1=permanent)
19-255	(not used, set to 0)

IMPORTANT SAFETY INSTRUCTIONS

Warning - When using electric products, basic precautions should always be followed, including the following:

1. Read all the instructions and observe the graphic symbols above before using the product.
2. Do not use this product near water - for example near a bathtub, washbowl, kitchen sink, in a wet basement, near or in a swimming pool, a swamp or the like.
3. This product should be used only with a cart or a stand that is recommended by the manufacturer.
4. This product, either alone or in combination with an amplifier and headphones or speakers may be perfectly capable of producing sound levels that could cause permanent hearing loss. Do not operate for a long period of time at a high volume level or at a level that is uncomfortable. If you experience any hearing loss or ringing in the ears, you should consult an audiologist.
5. The product should be located so that its location or position does not interfere with or obstruct its normal flow of ventilation.
6. The product should be located away from heat sources such as radiators, heat registers or other products that produce
7. The product should be connected to a power supply only of the type described in these operation instructions or as marked on the product.
8. The power supply cord of the product should be unplugged from the outlet when the product is left unused for a long period of time.
9. Care should be taken so that objects do not fall, or liquids are not spilled into the enclosure through openings.
10. The product should be serviced by qualified service personnel when:
 - A. The power supply cord has been damaged; or
 - B. Objects have fallen or liquids have been spilled onto the product; or
 - C. The product has been exposed to rain; or
 - D. The product does not appear to operate normally or exhibits a marked change in performance; or
 - E. The product has been dropped or the enclosure has been damaged.
11. Do not attempt to service the product beyond those means described in this operating manual. All other servicing should be referred to qualified service personnel.

FCC Information (U.S.A.)

1. IMPORTANT NOTICE: DO NOT MODIFY THIS UNIT! This product, when installed as indicated in the instructions contained in this Manual, meets FCC requirements. Modifications not expressly approved by Novation may void your authority, granted by the FCC, to use the product.
2. IMPORTANT: When connecting this product to accessories and/or another product use only high quality shielded cables. Cable/s supplied with this product MUST be used. Follow all installation instructions. Failure to follow instructions could void your FCC authorization to use this product in the USA.
3. NOTE: This product has been tested and found to comply with the requirements listed in FCC Regulations, Part 15 for Class "B" digital devices. Compliance with these requirements provides a reasonable level of assurance that your use of this product in residential environment will not result in harmful interference with other electronic devices. This equipment generates/uses radio frequencies and, if not installed and used according to the instructions found in the users manual, may cause interference harmful to the operation of other electronic devices. Compliance with FCC regulations does not guarantee that interference will not occur in all installations. If this product is found to be the source of interference, which can be determined by turning the unit "OFF" and "ON", please try to eliminate the problem by using one of the following measures:

Relocate either this product or the device that is being affected by the interference.
Utilize power outlets that are on different branch (Circuit breaker or fuse) circuits or install AC line filter/s.
In the case of radio or TV interference, relocate/re orient the antenna. If the antenna lead-in is 300 ohm ribbon lead, change the lead-in to co-axial type cable.
If these corrective measures do not produce satisfactory results, please contact the local retailer authorized to distribute this type of product.

The statements above apply ONLY to products distributed in the USA.

CANADA

The digital section of this apparatus does not exceed the "Class B" limits for radio noise emissions from digital apparatus set out in the radio interference regulation of the Canadian Department of Communications.

Le présent appareil numérique n'émet pas de bruits radioélectriques dépassant les limites applicables aux appareils numériques de la "Classe B" prescrites dans le règlement sur le brouillage radioélectrique édicté par le Ministère Des Communications du Canada.

This only applies to products distributed in Canada.
Ceci ne s'applique qu'aux produits distribués dans Canada.

Other Standards (Rest of World)

This product complies with the radio frequency interference requirements of the Council Directive 89/336/EC.

Dette apparat overholder det gældende EF-direktiv vedrørende radiofrekvensinterferens. Cet appareil est conforme aux prescriptions de la directive communautaire 89/336/EC.

Diese Geräte entsprechen der EG-Richtlinie 89/336/EC.

Specifications subject to change:

The information contained in this manual is believed to be correct at the time of going to press. However, Novation reserves the right to change or modify the specification without notice or obligation to update existing units.

Copyright 2002
Novation Electronic Music Systems Ltd. V1.2



KS Rack Technical Specification

Specifications

Architecture	
Voices	16
Modes	Program (Mono Timbral) Performance (Four Part multi timbral)
Part Edit	Note range / Fine/semi-tone detune / On-Off / Output select / MIDI channel
Audio Input	1 x 20 Bit A/D
Audio Outputs	4 x 24 Bit D/A

Oscillators 1, 2 and 3	
Waveforms	Square / Saw / Variable Pulse / Tri / Sine / Double Saw / Double Tri / Double Sine / 16 Complex Cycle Waveforms
Noise Sources	White / Crack / Metal 1 / Metal 2
Octave Range	Shift -1 / 0 / +1 / +2
Mod Env Depth	-64 to +63
LFO1 Depth	-64 to +63
PWM Source	Mod Env / Manual / LFO2
Ring Mod	1 * 2
FM	2 * 3
2 * 3 FM Level	0 – 127
2 * 3 FM Mod Level	0 – 127
FM Env Attack Rate	250uS-20 Seconds
FM Env Decay Rate	1mS-20 Seconds
Comprehensive Aftertouch, Breath and Pitch / Mod Wheel control of both static pitch and modulation of pitch	

Mixer	
Osc 1 Static Level	0 – 127
Osc 1 Mod Level / Lfo1	-64 to +63
Osc 2 Static Level	0 – 127
Osc 2 Mod Level / Lfo2	-64 to +63
Osc 3 Static Level	0 – 127
Osc 3 Mod Level / AD Env	-64 to +63
Noise Static Level	0 – 127
Noise Mod Level / Lfo1	-64 to +63
FM StaticLevel	0 – 127
FM Mod Level / AD Env	-64 to +63
Ext Input Static Level	0 – 127
Ext Input Mod Level / AD Env	-64 to +63

Filter	
Frequency	5Hz-24kHz
Slope	12dB / 24dB
Modes	Low Pass High Pass Band Pass
Resonance	0-Self Oscillation (24dB mode)
Mod Env Depth	-64 to +63
LFO 2 Depth	-64 to +63
Cut Off	0 – 127
Keyboard Tracking	0 – 127
Velocity	0 - 127
Overdrive	0 – 127
Q normalise	0 - 127
Comprehensive Aftertouch, Breath and Pitch / Mod Wheel control of both static filter freq and modulation of filter freq	

Amplifier & Modulation Envelopes	
Velocity	-64 to +63
Attack	250uS-20 Seconds
Decay	1mS-20 Seconds
Sustain	0 – 127
Release	1mS – 20 Seconds
Delay (Mod Env)	1mS-20 Seconds

LFO1 - LFO2	
Modes	Cyclic / One-shot
Waveforms	Sine / Tri / Saw / Squ / Sample & Hold / Sample & Hold / Quantize / Random 12 Intricate Waveables
Speed	0 Hz – 1Khz
Delay Fade In	0 – 5 Seconds
LFO Sync	Internal – MIDI Clock

Arpeggiator	
Arpeggiators	4 Independent
Controls	Speed / Range / Gate Time MIDI Clock / Sync / Keysync
Modes	Up / Down / Rand / Chord
Patterns	16 Rhythmic

Interfacing	
MIDI Sockets	In / Out / Thru
Audio Input	Line Level 1 x Mono 1/4" Jack
Audio Outputs	Line Level 1 x Mono 1/4" Jack
Pedals	Sustain / Expression 1/4" Jack

Effects	
Reverb	Level / Echo Chamber, Small Room, Large Room, Small Hall, Large Hall, Grand hall / Decay / Wheel Level
Chorus - Phaser	Level / Rate / Type / MIDI Clock Sync / Feedback / Mod Depth / Centre / MIDI clock sync initial Position, Wheel Level
Distortion	Drive / Compensation / Wheel Level
Panning	Position / Mod Depth / Speed / MIDI clock Sync, Initial Position
Delay	Depth / Time / Feedback / MIDI Clock Sync / Stereo Width / Ratio / Wheel Level
16 Band Vocoder	On -Off / Sibillance Level / Sibillance Type
EQ / Filter	Depth / Freq / Mod Depth / Mod Speed, MIDI clock sync / MIDI clock sync Initial position

General	
Power (AC Mains)	85 - 270 V.A.C 250mA
Dimensions (mm)	W=852 H=94 D=300 (KS4) W=1018 H=94 D=300 (KS5)
Weights	KS4 = 7.5kg / KS5 = 9.5kg

A-Station	2	DELAY Knob	18, 25
Active Sensing	57	Delay Time	41
AD Envelope	23, 35, 36, 39	Demonstration	8
Aftertouch	16, 21, 48, 49, 57	DETUNE Knob	18, 23, 36, 55
Calibration	49	Display	18, 32, 49
All Notes Off	57	Display Contrast	49
All Sound Off	57	Distortion	27, 28, 44, 51
Amp Envelope	18, 23, 26, 39, 40	Level Compensation	44
Amplifier	9, 12, 14, 47, 48, 51	Wheel Level	44
Amplifier Gain	47, 48	DRUM EDIT Button	5, 18, 32, 36
ARP LATCH Button	18, 28	Double Saw Sounds	22
ARP MENU Button	18, 29, 53	Drum Map Banks	3, 56
Arp Note Destination	54	Drum Maps	2, 3, 5, 6, 36, 56, 61
ARP ON Button	18, 28	Editing	5
Arp Sync Type	52	Effects	3, 6
Arpeggiators	2, 18, 27, 28, 29, 50, 52, 53 - 55	Saving	6
ATTACK Control	18, 26, 39	Selecting	3, 4, 56
Attack Time	13, 25, 26, 36, 39	Drum Patterns	54
Audio Input	2, 28, 39, 51	Duty Cycle	10
Audio Input Triggering	39, 40, 51	EDIT Buttons	7, 18
AUDITION Button	18, 32	Effects	2, 6, 18, 23, 27, 28, 29, 40, 41 - 46
Auto Glide	34	Chorus	27, 28, 29, 43, 50, 53
Back-ups	16, 49	Delay	27, 28, 41, 50, 52
Band Pass Filter	12, 24, 28, 37	Distortion	27, 28, 44, 51
Bank Change messages	4, 56	EQ	27, 28, 29, 45, 50, 53
BPM	28	Panning	28, 29, 46, 50, 53
Breath Control	21, 48	Reverb	27, 28, 42
BY CATEGORY Button	4, 18, 19, 20, 32	Vocoder	2, 28
Calibration	49	EFFECTS LEVEL Knob	18, 27, 28, 45, 46
Carrier	28	Elements Of A Sound	9
Categories	4, 6	Envelope Triggering	39
Cents Detune (Parts)	55	Envelopes	9, 12, 13, 14, 18, 21, 23, 25, 26, 39, 40, 51
Channels	7, 15, 16, 31, 50, 54, 55, 56	EQ	27, 29, 45, 50, 53
Chorus	27, 28, 29, 43, 50, 53	Frequency	27, 45
Feedback	43	Level	27
LFO Sync Initial Position	43	LFO Sync Initial Position	45
Mod Centre	43	Mod Depth	45
Mod Depth	43	Mod Rate	45
Sync Rate	53	Sync Mod Time	53
Type	43	External Audio	2, 23, 24, 28, 39, 40, 51
Wheel Level	43	External Audio To Effects	40, 51
Clock Messages	16, 50, 52, 57	Feedback (Chorus)	43
COMPARE Button	6, 18, 32	Feedback (Delay)	41
Connections	3	Filter	9, 11, 12, 14, 18, 21, 24, 37, 40, 47, 48, 51, 55
Contents	1	Aftertouch Modulation	48
Controllers	2, 15, 16, 55, 57, 62, 63	Breath Control Modulation	48
Conventions	2	Frequency Modulation From LFO 2 Using Mod Wheel	47
Cut-off Frequency	11, 12, 24, 25	Frequency Modulation From Mod Wheel	47
Data Compatibility	2	Self Oscillation	24
DECAY Control	18, 26, 39	FM Synthesis	23, 35, 36, 39
Decay Time	13, 25, 26, 36, 39	FM Amount	36
Decay Time (Reverb)	42	FM Manual Level	36
Delay	27, 28, 41, 50, 52	Foot Switch	55
Feedback	41	Frequency (EQ)	45
Sync Time	52	FREQUENCY Knob	11, 12, 15, 18, 20, 24, 37, 39
Wheel Level	41	Front Panel Layout	18
		Function Display Time	21, 51

Index

Gate Time	54	MIDI	2, 15 - 17, 31, 48, 49, 50, 54, 55, 56, 57
Global MIDI Channel	50, 55, 56	Aftertouch	16, 48, 49, 57
Global Parameters	19, 33, 49, 50, 51	Bank Select	16, 56
Dumping	49	Breath Control	21, 48
Restoring	49	Channels	7, 15, 16, 31, 50, 54, 55, 56
Saving	33, 50	Clock	16, 25, 28, 50, 52, 57
Global Sync Mode	38, 43, 45, 46, 50	Connections	15, 17
Harmonics	9, 10, 35	Controllers	2, 15, 16, 55, 57, 61, 62
High Pass Filter	12, 24, 37	Implementation Chart	16, 57
Highest Note	55	Note messages	15, 36, 57
Hypersync	2, 18, 27, 29, 30, 52	NRPNS	16, 64, 65
Naming	30	Pitch Bend	16, 57
Saving	30	Program Change	4, 16, 56, 57
HYPERSYNC Knob	18, 29	Specification	56
Index	75 - 78	Sustain	28, 55
Input Sensitivity Range	51	System Exclusive (Sysex)	2, 8, 16, 49, 57, 66 - 72
Input Trigger Sensitivity	39, 51	MIDI Clock Source	28, 50, 52
Input Trim dB	51	MIDI IN Port	15, 17
K-Station	2	MIDI OUT Port	4, 15, 17, 54
Keyboard Splits	7	MIDI THRU Port	15
Keypad Buttons	3, 4, 6, 18, 19, 20, 21, 33, 34, 37, 38, 39, 41, 47, 48, 49, 50, 51	Mod Centre (Chorus)	43
Keysync	54	Mod Depth (Chorus)	43
KS Rack	2	Mod Depth (EQ)	45
Left / Right Time Ratio	41	MOD ENV DEPTH Knob (Filter Section)	18, 24, 39
Level Compensation	44	MOD ENV DEPTH Knob (Oscillator Section)	18, 23
LFO Button	18, 25	Mod Envelope	18, 23, 24, 26, 39
LFO Common To All Voices	38	Mod Rate (EQ)	45
LFO Delay	18, 25, 29	Mode (Arpeggiators)	54
LFO Delay Sync Time	52	MODULATION Button	18, 23
LFO Keysync	38	Modulation Wheel	15, 18, 41, 42, 43, 44, 47, 49
LFO Keysync Initial Phase Offset	38	Calibration	49
LFO Polarity	38	Modulators	13, 28, 35
LFO Sync Initial Position (Chorus)	43	MORE LED	25
LFO Sync Initial Position (EQ)	45	Mixer	9, 11, 14, 18, 21, 22, 23, 37, 40
LFO Sync Initial Position (Panning)	46	Multi-timbral Operation	7
LFO Sync Speed	52	New Menu Always Page 1	51
LFO Triggering	38	Noise	9, 11, 23, 37
LFO Velocity	38	NOISE / RING / EXT Button	18, 23, 40
LFO 1 DEPTH Knob	18, 23	NOISE / RING / EXT / LFO 1 Knob	18, 23, 40
LFO 2 DEPTH Knob	18, 24	Noise Type	37
LFO 2 Level Modulation To OSC 1	37	NRPNS	16, 63, 64
LFOs	9, 13, 14, 18, 21, 22, 25, 29, 30, 38, 52	OCTAVE Button (Oscillator Section)	18, 22
Local Control	17, 50, 57	OCTAVE Buttons (Keyboard)	18, 26, 36
Low Pass Filter	11, 12, 24	Octave Range (Arpeggiators)	54
Lowest Note	55	ONE SHOT Button	18, 25
Manual Pan Position	46	Operating System Updates	16
Master keyboard	3, 16, 17, 50, 56	OSC Fixed Note Replay	36
Master Tune	50	OSC Sync	34, 35
Memories	14	OSC 1 / LFO 1 Knob	18, 23
Memory Protect	6, 8, 49, 50	OSC 2 / LFO 2 Knob	18, 23
Menu Mode	6, 21, 28, 52	OSC 3 / AD Knob	18, 23
MENU Button (Part)	7, 18, 31	OSCILLATOR Select Button	18, 22
MENUS Button	3, 6, 18, 21, 33, 34, 51, 52	Oscillators	2, 9, 11, 14, 18, 21, 22, 23, 34 - 36, 47, 48
		Aftertouch Modulation	47
		Breath Control Modulation	47
		Detuning	22
		LFO 1 Pitch Modulation	47

Mod Wheel Pitch Shift	47	Selecting	3, 4, 19, 33, 56
Pitch Bend Amount	47	Pulse Width	10
Selecting	22	PW SELECT Button	18, 22
Output Sockets	3, 54	PWM DEPTH / PW POSITION Knob	18, 22
OVERDRIVE Knob	18, 24		
PAGE Buttons	3, 7, 8, 18, 20, 21, 29, 32, 37, 46, 47,	Q Normalise	37, 51
.....	48, 50, 52, 54, 55	Rate (Chorus)	43
Panning	27, 29, 46, 50, 53	Rate (Panning)	46
LFO Sync Initial Position	46	RELEASE Control	5, 18, 26
Manual Pan Position	46	Release Time	13, 26
Rate	46	RESONANCE Knob	11, 18, 24, 37
Sync Rate	53	Reverb	27, 28, 42
Part Activate Buttons	18, 31	Decay Time	42
Part EDIT Buttons	7, 18, 31, 54	Type	42
PART LEVEL Knob	7, 18, 31	Wheel Level	42
Parts	2, 7, 8, 20, 31, 32, 54, 55	Ring Modulation	23
Editing	7		
Exporting	8	Safety CE Notices & Approvals	73
Layering	7	Sample & Hold	25
Muting	31	SAVE HYPER Button	18, 30
Selecting	19, 20, 33	SELECT Buttons (Effects)	18, 27, 28, 29, 41, 46
Part MENU Button	7, 18, 31, 55	SELECT Buttons	4, 18, 19, 20, 30, 32
Pattern Velocity	54	Semitone Detune (Parts)	55
Patterns	25, 54	SEMITONE Tune Knob	18, 23, 36, 55
Pedal	55	Sequencer	3, 4, 8, 17, 28, 29, 40, 49, 50, 52, 56
PERF Button	4, 7, 8, 18, 19, 21, 28, 33, 51	Sibilance Level	46
PERF / PROG / DATA Knob	3, 4, 6, 7, 8, 19, 20, 21,	Sibilance Type	46
.....	30, 32, 34, 36, 39, 40, 42, 44, 45, 51	SLOPE Button	11, 18, 24
Performance Mode	3, 7, 8, 19, 21, 28, 30, 31, 32,	SMF (Standard MIDI File)	16
.....	33, 49, 52, 56	Soft Thru	17
Performances	2, 4, 7, 8, 20, 32, 49, 55, 60	SOLO Button	18, 22
Comparing	32	SPEED Knob	18, 22, 25
Dumping	49	Start Phase	34
Editing	7	Stereo Width (Delay)	41
Saving	8, 21, 32, 33	Stereo Width (Vocoder)	46
Selecting	4, 19, 33, 56	Subtractive Synthesis	11
Phaser	43	SUSTAIN Control	5, 18, 26, 39
Pitch	9, 13, 23, 38	Sustain Level	13, 26
Pitch Bend Wheel	16, 18, 49, 57	Sustain Messages	28
Calibration	49	SYNC MENU Button	18, 30, 52
Polyphony Mode	34	Sync Mod Time (EQ)	53
PORTAMENTO Knob	18, 22, 34	Sync Rate (Chorus)	53
Portamento Mode	34	Sync Rate (Panning)	53
Preglide Semitones	34	Sync Time (Delay)	52
Presets	2, 3, 6, 29, 49, 58 - 60	Synthesis Tutorial	9
PROG Button	3, 5, 8, 18, 19, 21, 28, 33, 51	System Exclusive (Sysex)	2, 8, 16, 49, 57, 66 - 72
Prog Mode Display Control	51		
Program Banks	3, 16, 56	Technical Specification	74
Program Change	4, 16, 56, 57	TEMPO Knob	18, 27, 28, 50, 52, 56
Program Level dB	39	Thru Box	15
Program Mode	3, 6, 8, 19, 21, 30, 31, 32, 33,	Tone	9
.....	49, 51, 55, 56	Tracking	37
Programs	2, 3, 5, 6, 8, 20, 30, 32, 39, 49	TYPE Button	18, 24
Comparing	32	Type (Chorus)	43
Dumping	49	Type (Reverb)	42
Editing	5, 20		
Exporting	8, 21	Unipolar	38
Saving	6, 30, 32, 33	Unison Detune	34

Index

Unison Voices	34
Utilities	21, 49
VCO Drift	34
Velocity	57
Velocity Curve	50, 55
Velocity Sensitivity	37, 50
Velocity To Env Level	39
Vibrato	13, 24, 38
Vocoder	2, 28, 46
Activating	46
Sibilance Level	46
Sibilance Type	46
Stereo Width	46
Volume	9, 12, 26, 47, 54
VOLUME Knob	18, 26
WAVEFORM Knob (LFO Section)	18, 25
WAVEFORM Knob (Oscillator Section)	18, 22
Waveforms	9, 10, 11, 22, 23, 25, 34, 35, 38
Cross Fade	25
Curved Sawtooth	25
Digital	10
Noise	9, 10, 11
Pattern Trigger	25
Pulse	10
Quantized Sample & Hold	25
Sample & Hold	25
Sawtooth	9, 10, 25, 28
Sine	9, 10, 22, 25
Square	9, 10, 25
Triangle	9, 10, 13, 23, 24, 25, 38
White Noise	37
WRITE Button	6, 8, 18, 33